

SL Series

1U Programmable DC Power Supply • Rugged Current-Fed Power Processing



Overview

The SL Series builds on nearly 40 years of power supply innovation at Magna-Power, designed from the ground up to meet the highly reliable power dense demands of ATE system integrators through Magna-Power's signature current-fed power processing topology. Utilizing state-of-the-art semiconductors and innovative internally designed and manufactured heat sinks, the SL Series offers industry-leading 1U (1.75" height) programmable power levels with models at 1.5 kW, 2.6 kW, 4 kW, 6 kW, 8 kW, and 10 kW, while still maintaining an ambient operating temperature rating up to 50°C.

Models

	1.5 kW	2.6 kW	4 kW	6 kW	8 kW	10 kW		
Max Voltage (Vdc)	Max Current (Aac)						Ripple ¹ (mVrms)	Efficiency
5	250	N/A	N/A	N/A	N/A	N/A	30	84%
10	150	250	N/A	N/A	N/A	N/A	30	89%
16	93	162	250	N/A	N/A	N/A	40	89%
20	75	130	200	250	N/A	N/A	40	90%
25	60	104	160	240	N/A	N/A	50	91%
32	46	81	125	186	250	N/A	60	91%
40	37	65	100	150	200	250	80	91%
50	30	52	80	120	160	200	70	92%
60	25	43	66	100	133	166	100	93%
80	18	32	50	75	100	125	120	93%
100	15	26	40	60	80	100	120	93%
125	12	20	32	48	64	80	110	93%
160	9	16	25	36	50	60	110	93%
200	7.5	13	20	30	40	50	110	94%
250	6	10.4	16	24	32	40	110	94%
300	5	8.6	13.2	20	26.4	33.3	160	94%
375	4	6.9	10.4	16	21.3	26.5	160	94%
400	3.7	6.5	10	15	20	25	170	95%
500	3	5.2	8	12	16	20	250	95%
600	2.5	4.3	6.4	10	13.3	16.5	250	95%
800	1.8	3.2	5	7.5	10	12.5	350	95%
1000	1.5	2.6	4	6	8	10	400	95%
1250	1.2	2	3.2	4.8	6.4	8	700	95%
1500	1	1.7	2.6	4	5.3	6.6	1000	95%
AC Input Voltage (Vac)	Input Current Per Phase (Aac)							
UI (100-240 Vac, 1Φ)	21-7	N/A	N/A	N/A	N/A	N/A		
UI2 (208-240 Vac, 1Φ)	N/A	16-12	N/A	N/A	N/A	N/A		
208/240 Vac, 3Φ	6	11	16	24	32	39		
380/415 Vac, 3Φ	5	8	11	16	19	22		
440/480 Vac, 3Φ	4	6	9	14	17	19		

Key Features

- SCPI Remote Programming API
- High Accuracy Measurements
- Master-Slave Functionality
- Remote Sensing
- 37-Pin External User I/O
- RS232 Interface
- Ethernet and GPIB Available
- 0-10V External Analog Inputs
- Programmable Protection Limits
- Fast Transient Response
- Remote Interface Software
- NI LabVIEW™ and IVI Driver
- Interlock Shutdown Input
- Designed and Manufactured in the USA

Available Options

- High Slew Rate Output (+HS)
- IEEE-488 GPIB Communications (+GPIB)
- LXI TCP/IP Ethernet Communications (+LXI)
- Ruggedized (+RUG)

SL Series Model Ordering Guide

There are 127 different models in the SL Series spanning power levels: 1.5 kW, 2.6 kW, 4 kW, 6 kW, 8 kW, 10 kW.

To determine the appropriate model:

1. Select the desired Max Voltage (Vdc) from the left-most column.
2. Select the desired Max Current (Aac) from the same row that contains your desired Max Voltage.
3. Construct your model number according to the model ordering guide.

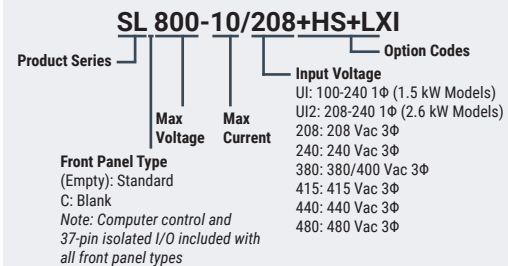

¹ Ripple specified for standard models. Ripple will be higher for models with the High Slew Rate Output (+HS). Refer to option page for more details.

Specifications

AC Input Specifications

1Φ AC Input Voltage 1 Φ , 2-wire + ground	100 to 240 Vac (UI: Universal input; 1.5 kW Models) 208 to 240 Vac (UI2: Universal input; 2.6 kW Models)
3Φ AC Input Voltage 3 Φ , 3-wire + ground Available on all models	208 Vac (operating range 187 to 229 Vac) 240 Vac (operating range 216 to 264 Vac) 380/400 Vac (operating range 342 to 440 Vac) 415 Vac (operating range 373 to 456 Vac) 440 Vac (operating range 396 to 484 Vac) 480 Vac (operating range 432 to 528 Vac)
AC Input Current	Refer to chart of available models
AC Input Frequency	50-400 Hz
Power Factor	0.99 at max power; models with 1 Φ AC input >0.82 at max power; models with 3 Φ AC input
AC Input Isolation	\pm 2500 Vac, maximum input voltage to ground

Output Specifications

Voltage Ripple	Refer to chart of available models.
Line Regulation	Voltage mode: \pm 0.004% of full scale Current mode: \pm 0.02% of full scale
Load Regulation	Voltage mode: \pm 0.01% of full scale Current mode: \pm 0.04% of full scale
Load Transient Response	2 ms to recover within \pm 1% of regulated output with a 50% to 100% or 100% to 50% step load change
Stability	\pm 0.10% for 8 hrs. after 30 min. warm-up
Efficiency	84% to 95%; refer to chart of available models
DC Output Isolation	\pm 1500 Vdc, max output voltage to ground

Programming Specifications

Programming Accuracy	Voltage: \pm 0.075% of max voltage rating Current: \pm 0.075% of max current rating
Measurement Accuracy	Voltage: \pm 0.2% of max voltage rating Current: \pm 0.2% of max current rating
Maximum Slew Rate Standard Models	< 170 ms, output voltage change from 0 to 63% < 200 ms, output current change from 0 to 63%
Maximum Slew Rate Models with High Slew Rate Option (+HS)	< 5 ms, output voltage change from 0 to 63% < 10 ms, output current change from 0 to 63%
Trip Settings Range	Over Voltage: 10% to 110% max voltage rating Over Current: 10% to 110% max current rating
Computer Command Protocol	Standard Commands for Programmable Instruments (SCPI)
Remote Sense Limits Wired; Available on Models Rated \leq 1000 Vdc	3% maximum voltage drop from output to load

Connectivity Specifications

Communication Interfaces (Standard)	RS232: DB-9, Female External User I/O: DB-37, Female
Communication Interfaces (Optional)	LXI TCP/IP Ethernet: RJ-45 GPIO: IEEE-488

External User I/O Specifications

Digital Inputs	5 V, 10 k Ω impedance
Digital Monitoring Signals	5 V, 5 mA capacity
Digital Reference Signal	5 V output, 25 mA capacity
Analog Programming Input	0-10 V
Analog Programming Impedance	10 k Ω
Analog Monitoring Signals	0-10 V, 5 mA capacity
Analog Monitoring Impedance	100 Ω
Analog Monitoring Accuracy	0.2% of max rating
Analog Reference Signal	10 V, 5 mA capacity, 1 Ω impedance

Physical Specifications

Racking Standard	EIA-310
Rear Support Rails	Included

Power Level	Rack Units	Size	Weight
1.5 kW	1U	1.75" H x 19" W x 24" D (4.4 x 48.3 x 61.0 cm)	32 lbs (14.52 kg)
2.6 kW	1U	1.75" H x 19" W x 24" D (4.4 x 48.3 x 61.0 cm)	34 lbs (15.42 kg)
4 kW	1U	1.75" H x 19" W x 24" D (4.4 x 48.3 x 61.0 cm)	35 lbs (15.88 kg)
6 kW	1U	1.75" H x 19" W x 24" D (4.4 x 48.3 x 61.0 cm)	35 lbs (15.88 kg)
8 kW	1U	1.75" H x 19" W x 24" D (4.4 x 48.3 x 61.0 cm)	36 lbs (16.33 kg)
10 kW	1U	1.75" H x 19" W x 24" D (4.4 x 48.3 x 61.0 cm)	37 lbs (16.78 kg)

Environmental Specifications

Ambient Operating Temperature	-25°C to 50°C
Storage Temperature	-40°C to +85°C
Humidity	Relative humidity up to 95% non-condensing
Air Flow	Side air inlet, rear exhaust
Temperature Coefficient	0.04%/°C of maximum output voltage 0.06%/°C of maximum output current

Regulatory Compliance

EMC	Complies with 2014/30/EU (EMC Directive) CISPR 22 / EN 55022 Class A
Safety	NRTL Listed, TÜV SÜD Certificate U8 123461 0001 Tested to UL 61010-1:2012/R:2019-07 and CSA C22.2 No. 61010:2012/A1:2018-11 Complies with EN61010-1 and 2014/35/EU (Low Voltage Directive)
CE Mark	Yes
RoHS Compliant	Yes

Note: Specifications are subject to change without notice. Input voltage specifications are line-to-line.

SL Series

1U Programmable DC Power Supply • Rugged Current-Fed Power Processing

Product Diagrams

Front Panel

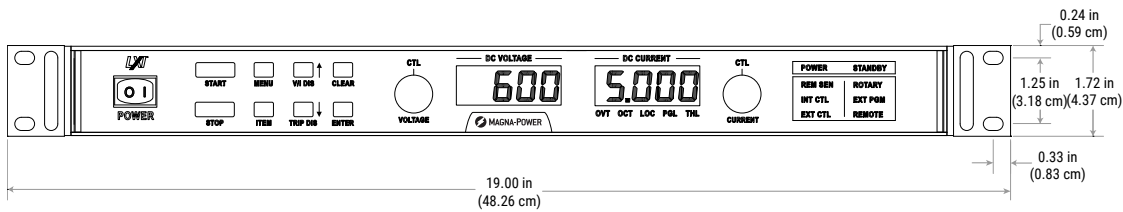

Rear Panel

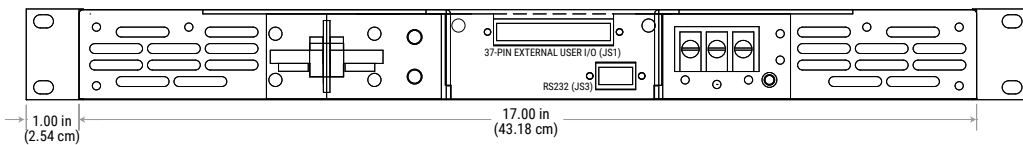

Top Rear View

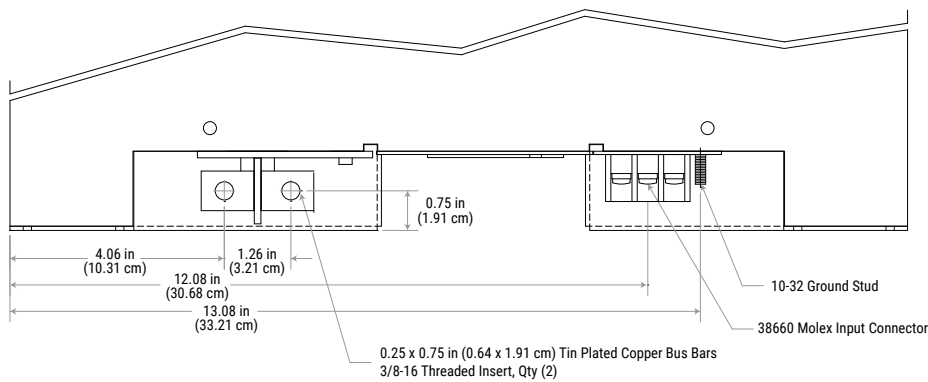

Side Panel

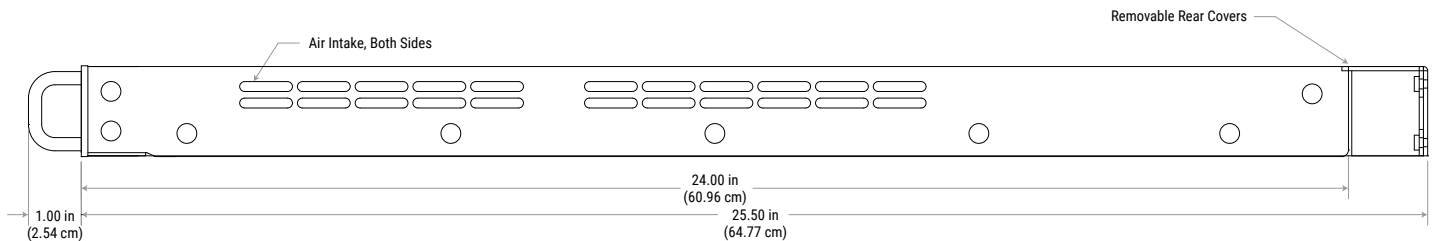

Communications

IEEE-488 GPIB (+GPIB) Option

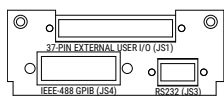

Communications

LXI TCP/IP Ethernet (+LXI) Option

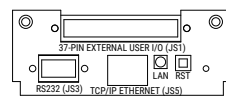

Front Panel Overview

Standard SL Series Front Panel

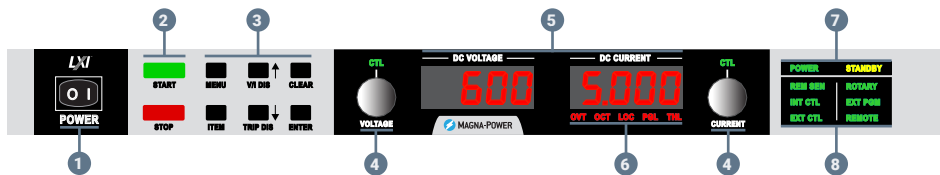

C Version Front Panel - Blank



- 1 Power switch energizes control circuits without engaging main power
- 2 Engages and disengages main power via integrated mechanical contactor
- 3 Function Keys
MENU: Selects function
ITEM: Selects item within function
V/I DIS: Displays voltage and current settings
TRIP DIS: Displays OVT and OCT setting
CLEAR: Clears settings or resets fault
ENTER: Select item
- 4 Stepless rotary knob to set voltage and current
- 5 Meters display output voltage, output current, voltage set point, current set point, over voltage trip and over current trip
- 6 Diagnostic Alarms
LOC: Interlock
PGL: External input voltage beyond limits
THL: Over-temperature condition
OVT: Over-voltage protection has tripped
OCT: Over-current protection has tripped
- 7 POWER: Indicates power output
STANDBY: Indicates control power only
- 8 REM SEN: Remote sense enabled
INT CTL: Front panel start/stop/clear enabled
EXT CTL: External start/stop/clear enabled
ROTARY: Front panel rotary knob input
EXT PGM: External analog voltage-current control
REMOTE: Computer control



MagnaDC Overview

Fully Programmable DC Power

MagnaDC programmable DC power supplies features programmable voltage, current, and protection settings along with high accuracy measurements. The SL Series functions and features are accessible and configurable from a variety of control methods, including:

- Front panel interface with stepless knobs
- 37-pin isolated analog-digital user I/O
- RS232 Computer interface with software and drivers

Various additional programming interfaces are available, such as LXI TCP/IP Ethernet (+LXI), IEEE-488 GPIB (+GPIB), Edgeport USB Accessory (+USB), RS485 Accessory (+RS485).

Current-Fed Topology: Robust Power Conversion

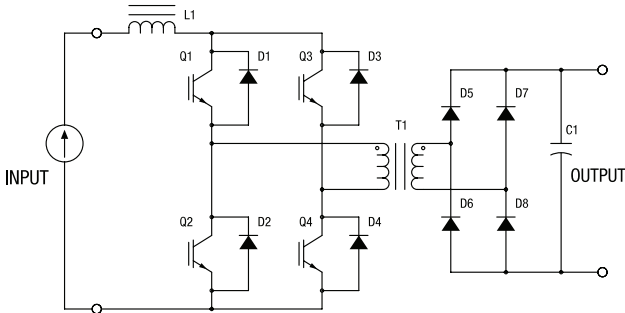

All MagnaDC programmable DC power supplies utilize high-frequency IGBT-based power processing in current-fed topology. This topology adds an additional stage over the conventional voltage-fed topology for enhanced control and system protection, ensuring that even under a fault condition, the power supply will self-protect. Due to the self-protecting characteristics of this topology, the possibility of fast rising current spikes and magnetic core saturation is eliminated.

In addition to its robust topology, key performance characteristics of MagnaDC programmable DC power supplies include:

- High-accuracy voltage and current programming accuracy
- Class-leading line and load regulation performance
- High 3 Φ AC input power factor with in-rush limiting circuitry
- Computer and user I/O isolated from the power supply output

All Magna-Power Electronics power supplies contain circuitry to work harmoniously with other power equipment. Step-start contactors are used to keep inrush current below full scale operating current. Filter components lower current harmonic content emanating from the power supply and increase power factor to levels beyond 90%. Every power supply is tested at 90% to 125% nominal line to ensure satisfactory operation even under the worst line voltage conditions.

Designed for Safety

MagnaDC programmable DC power supplies have extensive diagnostic functions, including:

- AC Phase Loss
- Excessive Thermal Conditions
- Over Voltage Trip (Programmable)
- Over Current Trip (Programmable)
- Cleared Fuse
- Excessive Program Line Voltage
- Interlock Fault

When in standby or diagnostic fault, the AC mains are mechanically disconnected by an embedded AC contactor, providing confidence that the unit is only processing power when desired.

Finally, with a dedicated +5V interlock input pin and included +5V reference on all models, external emergency stop systems can be easily integrated using an external contact.

Included Software Interface: RIS Panel

The Remote Interface Software ships with all power supplies. The software provides the user with an easy and intuitive method to operate a Magna-Power Electronics power supply with computer control. The Remote Interface Software has six windows: Virtual Control Panel, Command Panel, Register Panel, Calibration Panel, Firmware Panel, and Modulation Panel.

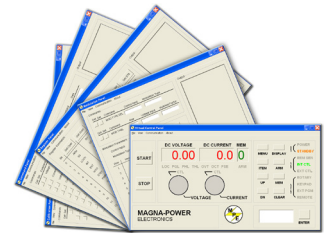

High-Performance Plug and Play Master-Slaving

The MagnaDC programmable DC power supplies' master-slaving strategy helps to ensure no degradation in performance as units are added in parallel or series by providing gate drive signals directly to the slave units from the master. This strategy eliminates the noise susceptibility commonly found when sending analog control references over long distances, in addition to maintaining a single control loop.

The UID47 eases master-slave parallel or series configuration of Magna-Power DC power supplies, enabling near equal current or voltage sharing, depending on the configuration.



Isolated External I/O For Hardware-in-the-Loop or PLC Control

Using the rear isolated 37-pin I/O connector, the MagnaDC programmable power supplies can be completely controlled and monitored using external signals. The voltage, current, over voltage and over current set points are set by applying a 0-10V analog signal. Each diagnostic condition is given a designated pin, which reads +5V when high. Reference +5V and +10V signals are provided, eliminating the need for external voltage signals and allowing the use of dry contacts.

Also, the power supply features a normally closed external interlock, which when enabled, allows the power supply to be tied in with other emergency stop equipment. All these pins are isolated from the output terminals and referenced to earth-ground as standard—no additional isolation equipment or options necessary.

The following list summarizes the available I/O from the power supply:

- 4 analog inputs
- 2 analog outputs
- 5 digital inputs
- 15 digital outputs
- +2.5V, +5V and +10V reference signals

With the High Slew Rate Output (+HS) option equipped, high bandwidth operation is enabled along with fast rise times, allowing the MagnaDC programmable DC power supplies to address requirements for Hardware-in-the-Loop (HIL).

Extensive Programming Support

All MagnaDC programmable DC power supplies come with a dedicated National Instruments LabVIEW™ driver, Interchangeable Virtual Instrument (IVI) driver, and support for a wide range of Standard Commands for Programmable Instrumentation (SCPI). These programming interfaces support full control, measurement, and monitoring of the MagnaDC power supply. All of the MagnaDC power supplies are available communication interfaces are supported by these drivers and command sets, including: RS232, LXI TCP/IP Ethernet, IEEE-488 GPIB, USB or RS485.

Showcased in the following basic code examples, SCPI commands provide the simplest form of communication by using plain ASCII text and parameters sent over a basic socket connection. Over 50 commands are provided, with detailed documentation in the SL Series User Manual.

Python programming example using SCPI commands

```
import serial
conn = serial.Serial(port='COM8', baudrate=19200)
conn.write('*IDN?\n')
print conn.readline()
conn.write('VOLT 1000\n')
conn.write('CURR 5\n')
conn.write('OUTP:START\n')
conn.write('MEAS:CURR?\n')
print conn.readline()
```

Designed and Manufactured in the USA



For complete control of quality, MagnaDC programmable DC power supplies are designed and manufactured at

Magna-Power's vertically integrated USA manufacturing facility in Flemington, New Jersey. Heat-sinks and chassis are machined from aluminum. All sheet metal is fabricated and powder coated in-house. Magnetics are wound-to-order from validated designs based on a model's voltage and current. An automated surface-mount production line places components on printed circuit boards for control, driver, auxiliary power, and display circuits. And finally after assembly, products undergo comprehensive test and NIST-traceable calibration, followed by an extended burn-in period.

Tailor Performance with Integrated Options

Magna-Power's MagnaDC programmable power supplies are designed to be flexible, depending on the application's requirements. With its configured-to-order integrated options, including:

- Blocking Diode (+BD)
- IEEE-488 GPIB (+GPIB)
- High Slew Rate Output (+HS)
- High Isolation Output (+ISO)
- LXI TCP/IP Ethernet (+LXI)
- Ruggedized (+RUG)
- Water Cooling (+WC)





Innovation in Programmable Power

Magna-Power designs and manufactures robust programmable power products in the USA that set industry standards for quality, size, and control. The company's experience in power electronics is reflected in its 1.25 kW to 2000 kW+ product line, quality service, and reputation for excellence. Today, you will find Magna-Power's standard products at its thousands of customers worldwide, aiding in the manufacture of electric vehicles, simulating solar arrays for development of inverters, steering magnets for particle accelerators, powering radar systems, driving traction controllers for locomotive development, or at a wide range of Universities for cutting-edge energy research.

Quick Facts

Year Founded

1981

Total Power Shipped

390+ megawatts

Headquarters and Manufacturing Location

Flemington, New Jersey USA

Facility Size

73,500 ft²

Vertically Integrated USA Manufacturing

Magna-Power Electronics products are proudly made in the USA at the company's vertically integrated, company designed and owned 73,500 ft² headquarters in Flemington, New Jersey. All engineering, manufacturing and North America product servicing is performed at the company's headquarters.

Magna-Power Electronics utilizes vertical integration in its manufacturing process for complete control over quality, cost, and lead-time of its made-to-order products. As the company has grown, more operations have been internalized.

Vertical integration enables Magna-Power to manufacture a very broad line of sophisticated electronic products, while still maintaining industry leading lead-times. Housing engineering and manufacturing teams in the same facility forces strong collaboration between the two teams for continual process and product improvements.

Internal Company Processes

- Research and development
- Magnetics winding
- Magnetic core punching and cutting
- Full sheet metal operations
- EDM and CNC machining
- Cable harnessing
- Powder coating
- Robotic air- and water-cooled heat-sink fabrication
- Surface-mount and through-hole printed circuit board assembly
- Final assembly, testing, and burn-in

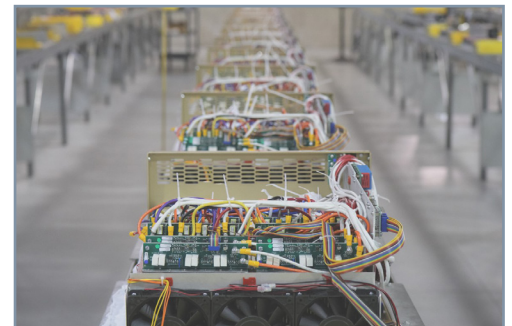
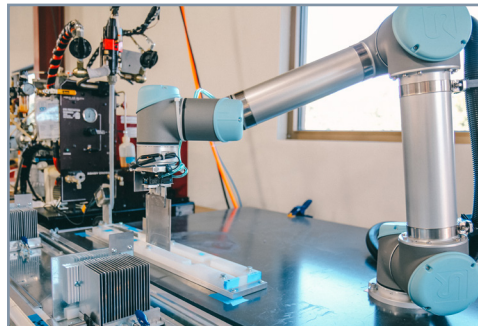
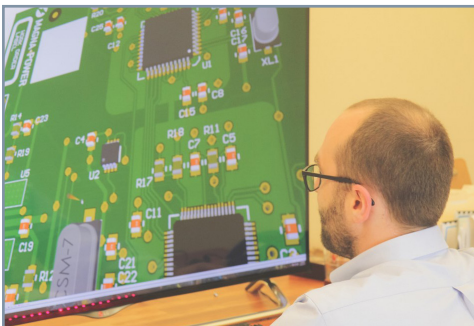

Blocking Diode (+BD)

The integrated **Blocking Diode (+BD)** option provides an internally heat-sunk protection diode on the positive output terminal of a MagnaDC programmable DC power supply. This diode protects the product's output from reverse voltage up to 1200 Vdc. All voltage sensing is performed after the protection diode—at the product's output terminals—making the diode's operation completely transparent to the performance of the power supply.

The +BD option is recommended for applications where there is significant back-emf or the possibility of a DC output voltage that could exceed the power supply's output voltage rating, such as:

- DC motor drives
- Battery and capacitor charging
- Large electromagnets

In these applications, the integrated blocking diode can be used to prevent back-emf from the energy stored in the load into the power supply's output. Furthermore, the integrated blocking diode will prevent the power supply's internal bleed resistance from discharging the energy stored in the load when the power supply is off or in standby.

Availability

The +BD option is available for models with maximum output voltage rating as specified for the following product series:

- TS Series, models rated from 40 Vdc to 1000 Vdc
- MS Series, models rated from 40 Vdc to 1000 Vdc
- MT Series, models rated from 125 Vdc to 1000 Vdc

The +BD option cannot be combined with the +ISO option.

Specifications

Additional Specifications for Blocking Diode (+BD) Option

Reverse Voltage Rating

Models Rated 1200 Vdc
125 Vdc to 1000 Vdc

Reverse Voltage Rating

Models Rated 200 Vdc
Below 125 Vdc

Additional Losses

Models Rated Up to 1.4%
125 Vdc to 1000 Vdc

Additional Losses

Models Rated Up to 2.5%
Below 125 Vdc

High Isolation Output (+ISO)

Certain applications require floating the output voltage to values beyond the power supply isolation rating. Magna-Power's **High Isolation Output Option (+ISO)** enables a TS Series, MS Series or MT Series model with a peak output voltage rating of 250 Vdc through 1000 Vdc to be rated for a higher voltage output isolation. Improved isolation is achieved by a novel output stage with improved controller isolation. In addition to being able to float the power supply to a higher output voltage, this option also enables lower voltage units to be tied together in series up to its new higher isolation rating, in accordance with the table in the Specifications section below.

Availability

The +ISO option is available for models with maximum output voltage rating as specified for the following product series:

- TS Series, models rated from 250 Vdc to 1000 Vdc
- MS Series, models rated from 250 Vdc to 1000 Vdc
- MT Series, models rated from 250 Vdc to 1000 Vdc

The +ISO option cannot be combined with the +BD or +WC options. Addition of the +ISO option will cause the product's wired remote sense feature to be removed.

Specifications

Output Isolation Rating for Various Configurations

Product Series	Output Isolation Standard, No Option	Output Isolation for Models Rated 250-1000 Vdc With +ISO Option	Output Isolation for Models Rated Above 1000 Vdc; Standard, No Option Necessary
SL Series	±1500 Vdc	N/A	N/A
XR Series	±1500 Vdc	N/A	±(1500 Vdc + Vo/2)
TS Series	±1000 Vdc	±(3000 Vdc + Vo/2)	±(3000 Vdc + Vo/2)
MS Series	±1000 Vdc	±(3000 Vdc + Vo/2)	±(3000 Vdc + Vo/2)
MT Series	±1000 Vdc	±6000 Vdc	±6000 Vdc

High Slew Rate Output (+HS)

The High Slew Rate Output (+HS) solves several limitations inherent in switching power supply design. Rapid voltage transitions require internal electronics to supply the energy to charge and discharge output capacitors. Peak currents internal to the power supply define slew rate; utilizing less capacitance enables voltage transitions in shorter time periods. Additionally, less capacitance reduces requirements for discharge demands during open circuit conditions.

The standard output stage Magna-Power Electronics power supplies has been designed to provide the lowest possible output ripple voltage within the constraints of available components, size, and cost. Part of the output stage consists of a bank of aluminum electrolytic capacitors which has the desired electrical properties to provide this function. These components require bleed resistors to discharge any voltage when the power supply has no load and is disabled. While the presence of these components and the resulting performance are normally industry accepted, there are applications where lower output capacitance and lower loss bleed resistors are extremely desirable and higher ripple voltage is acceptable. To meet this need, a high-slew rate option is available which has an output stage consisting of low capacitance film and aluminum electrolytic capacitors and lower loss bleed resistors. Applications for the high-slew rate option include battery charging, photovoltaic emulation, power waveform generation, and medium speed power pulsing. These applications all benefit from higher bandwidth and in many cases, can tolerate increased ripple voltage.

Key Applications

For battery charger applications, output capacitance and internal bleed resistors present themselves as a load to the connecting batteries. One common practice is to use a series diode to block reverse current flow with the sacrifice of increased cost and lower efficiency. The high slew rate option, with its lower output capacitance and lower loss bleed resistors, enables direct connection to batteries without series blocking diodes.

For photovoltaic emulation applications, higher bandwidth and lower output capacitance enable improved performance with higher speed, maximum power tracker algorithms. Maximum power tracker circuitry deviates the operating point of photovoltaic arrays to determine maximum power output. Slow responding emulation sources can present a problem when the speed of the algorithm exceeds that of the source. Furthermore, with lower output capacitance, changes in the operating point and transients, caused by shorting the solar inverter input, produce lower unwanted input currents.

The high-slew rate option enables the power supply to operate as a low frequency, power pulse generator. With the special capacitors selected for this option, it is possible to superimpose waveforms or produce a medium speed pulse on top of the dc output and expect normal capacitor life. It is important to note that the power supply output is single quadrant; that is, the output voltage or current cannot reverse.

Availability

The +HS option is available for the following product series:

- SL Series
- XR Series
- TS Series
- MS Series
- MT Series

XR Series models greater than 2000 Vdc already include a high slew rate output stage and no additional +HS option is available for these models.

Additional Specifications for High Slew Rate Output (+HS) Option

Max Voltage Rating	Output Capacitance SL Series (μF)	Output Capacitance XR Series (μF)	Output Capacitance TS Series MS Series (μF) ¹	Ripple (Vrms)
5	4235	13200	13200	0.5
8	N/A	N/A	9000	0.5
10	1740	4080	9000	0.5
16	1740	4080	4080	0.5
20	775	2340	2340	0.7
25	775	1170	2340	0.7
32	775	1170	1170	1.4
40	760	240	1170	1.5
50	760	240	1170	1.5
60	760	240	300	1.5
80	110	240	300	1.5
100	110	160	200	1.6
125	70	160	200	1.6
160	70	160	200	1.6
200	70	160	200	1.6
250	70	160	200	1.6
300	70	160	200	1.8
375	70	160	200	1.8
400	70	160	200	1.8
500	40	56	200	2.1
600	40	56	120	2.3
800	30	52	70	2.5
1000	30	52	60	3.0
1250	N/A	18	18	3.5
1500	N/A	18	18	3.5
2000	N/A	18	18	3.5
3000	N/A	N/A	9	4
4000	N/A	N/A	9	4
6000-10000	N/A	N/A	N/A	N/A

¹ For 20 to 30 kW models, multiply capacitance by 2
 For 45 kW models, multiply capacitance by 3
 For 60 kW models, multiply capacitance by 4
 For 75 kW models, multiply capacitance by 5
 For TS Series 4U/8U models and MT Series models, please contact Magna-Power support.

IEEE-488 GPIB (+GPIB)

The **IEEE-488 GPIB (+GPIB)** option, sometimes called the General Purpose Interface Bus (GPIB), is a general purpose digital interface system that can be used to transfer data between two or more devices. It is particularly well-suited for interconnecting computers and instruments. Some of its key features are:

- Up to 15 devices may be connected to one bus
- Total bus length may be up to 20 m and the distance between devices may be up to 2 m
- Communication is digital and messages are sent one byte (8 bits) at a time
- Message transactions are hardware handshaked
- Data rates may be up to 1 Mbyte/sec

The IEEE-488 GPIB interface is integrated with the power supply's rear communication ports. The IEEE 488 interface offers full compatibility with Magna-Power provided drivers, software and SCPI command set.

Availability

The +GPIB option is available for the following product series:

- SL Series
- XR Series
- TS Series
- MS Series
- MT Series

LXI TCP/IP Ethernet (+LXI) *LXI*

Certified to the LXI Standard (Class C), version 1.4, the **LXI TCP/IP Ethernet (+LXI)** allows the product to be fully controlled over an integrated TCP/IP Ethernet interface. LXI is an instrumentation platform based on industry standard Ethernet technology designed to provide modularity, flexibility, and performance to small- and medium-sized systems. All of the product's standard SCPI commands are supported over the +LXI option, along with all provided software and drivers.

LXI's advantages are exemplified in its compact, flexible package providing high-speed I/O and reliable measurements. The Magna-Power Electronics LXI TCP/IP Ethernet option includes an embedded web-server, allowing web browser power supply control and monitoring from virtually anywhere.

Availability

The +LXI option is available for the following product series:

- SL Series
- XR Series
- TS Series
- MS Series
- MT Series

Ruggedized (+RUG)

The **Ruggedized Option (+RUG)** provides additional mechanical security for large power components and sub-assemblies within SL Series and XR Series products.

SL Series and XR Series units with the Ruggedized Option have been independently tested to comply with the following MIL-STD-810G shock and vibration specifications:

- MIL-STD-810G CHG1 Method 516.7 Functional Shock, Procedure I; which subjects the product to 40G, 11 ms terminal saw tooth pulse; three shocks in each direction along three mutually perpendicular axes
- MIL-STD-810G CHG1 Method 514.7 Vibration; which subjects the product to two hours of vibration per axis along three mutually perpendicular axes

All products with the Ruggedized Option maintain ambient operating temperatures from 0°C to 50°C and ambient storage temperatures from -25°C to +85°C.

Availability

The +RUG option is available for the following product series:

- SL Series
- XR Series

Water Cooling (+WC)

The **Water Cooling (+WC)** option is available for Magna-Power power supplies for use in densely packaged system cabinets, where heat removal by the product's standard air cooling presents a challenge.

Water cooling is accomplished with chill plates and an integrated central heat exchanger. The chill plates provide a thermal conduction path for heat sensitive components and the central heat exchanger removes heat from air internal to the enclosure. An internal solenoid valve enables water flow when the chill plate reaches 60°C. Operation of the solenoid prevents internal condensation.

3U and 4U models have a 1/4" NPT male inlet and outlet for water flow. For 6U, 8U, and floor-standing models, external plumbing interconnects power supply modules to a single 1/2" NPT male connection: one for inlet, one for outlet. A minimum of 2.5" is recommended behind the enclosure for this hardware and user connections. For systems requiring more than one power supply, plumbing connections must be paralleled; that is, water should not flow from one power supply into another.

When water cooled power supplies are ordered in combination with the Cabinet and Integration accessory, Magna-Power will parallel the water inlet connections and parallel the water outlet connections, providing a single inlet and outlet for the rack.

Availability

The +WC option is available for models with maximum output voltage rating as specified for the following product series:

- TS Series, models rated from 1000 Vdc and below
- MS Series, models rated from 1000 Vdc and below

The +WC option cannot be combined with the +ISO option.

Specifications

Refer to the individual product series specifications.

Cabinet and Integration

Magna-Power's heavy-duty cabinet enclosures—fabricated by Magna-Power and available with or without product integration—are trusted by customers across many industries, including: military and defense, aerospace, industrial research and development, product testing, and education.

- **Cold-rolled USA 1008 steel**
Magna-Power's cabinet enclosures begin with 12-gauge cold-rolled USA 1008 steel that gets bent and welded within Magna-Power's metal processing operations. The resulting heavy-duty frame is then powder coated, with ground-plane surfaces carefully masked.
- **EIA-310 standard**
Vertical EIA-310 rails spanning the length of the cabinet in the front and rear are fabricated from 12-gauge galvanized steel.
- **Casters or pedestal base**
Standard 700-pound per caster rating with low resistance bearings allows heavy loads to be rolled with ease. An optional welded pedestal base increases the weight limit to over 4,000 lbs.

Specifications

Configuration	Integrated Units Cooling Method	Dimensions	Internal Rack Space
A1	Air	31.5" H x 24" W x 31.5" D (80.0 x 55.6 x 80.0 cm)	12U
B1	Water		
A2	Air	51" H x 24" W x 31.5" D (129.5 x 61.0 x 80.0 cm)	24U
B2	Water		
A3	Air	67" H x 24" W x 31.5" D (170.2 x 61.0 x 80.0 cm)	30U
B3	Water		
A4	Air	74" H x 24" W x 31.5" D (188.0 x 61.0 x 80.0 cm)	36U
B4	Water		
A5	Air	67" H x 48" W x 31.5" D (170.2 x 122.0 x 80.0 cm)	30Ux2 (60U Total)
B5	Water		
A6	Air	74" H x 48" W x 31.5" D (188.0 x 122.0 x 80.0 cm)	36Ux2 (72U Total)
B6	Water		
A7	Air	67" H x 72" W x 31.5" D (170.2 x 182.9 x 80.0 cm)	30Ux3 (90U Total)
B7	Water		
A8	Air	74" H x 72" W x 31.5" D (188.0 x 182.9 x 80.0 cm)	36Ux3 (108U Total)
B8	Water		



Qty (39) SL Series units in Qty (2) CAB2 (left) and Qty (1) CAB1 (right)

Cooling Solutions

Beyond the installation, Magna-Power also provides necessary cooling integrations for its cabinet enclosures, designed to integrate with Magna-Power programmable DC power supplies and electronic loads. Different cooling solutions are provided, as standard, depending on whether the integrated products are air or water cooled.

- **2,300 CFM+ air cooling**
For air cooled products integrated into the enclosure, high-quality top-mounted fans are installed to pull air from the enclosure's bottom opening and exhaust from the top. A provided control transformer with separate fusing allows fans to be powered from the same voltage as the integrated products. In addition, an integrated relay ensures the fans are not turned on unless the integrated product's control power is enabled.
- **Copper water cooling manifold**
For water cooled products integrated into the enclosure, a copper manifold is machined-to-order to provide a single inlet and outlet for the cabinet, with PEX tubing internally paralleling inlet and outlet cooling paths for the installed products.

Custom Integrations

Standard integration by Magna-power includes a full enclosed cabinet with casters and suitable cooling. Various additional accessories are available. Contact your Magna-Power sales partners for more information on custom integration.

Ordering Guide

There are many standard Magna-Power rack enclosure configurations available. The ordering guide below provides a guide for configuring standard rack enclosures. Custom rack enclosures will receive a special part number from Magna-Power's sales team.

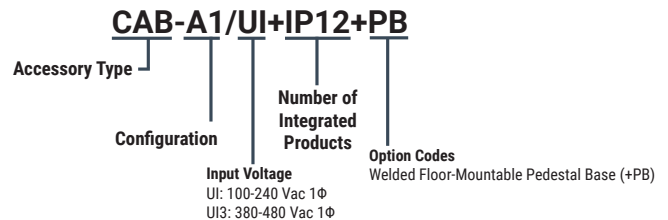

Qty (4) XR Series units in a CAB1

Accessories

DC Power Cables

Magna-Power offers a variety of DC power cables, built and tested in-house utilizing Magna-Power's internal cable manufacturing operations.

Ordering Guide

There are many DC cable configurations available, depending on the requirement. The ordering guide below provides a guide for configuring the appropriate cable configuration Refer to the product diagrams for the respective product series for the DC output bus thread size and number of connection points.

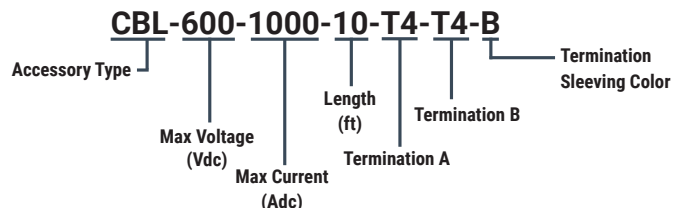

The following table provides availability of cable ratings and terminations:

Max Voltage	Max Current							Length	Termination						Termination Sleeving Color
	3.3 Adc	55 Adc	100 Adc	160 Adc	223 Adc	310 Adc	1000 Adc ¹		T0	T1	T2	T3	T4	T5	
600 Vdc	x	x	✓	✓	x	x	x	5, 10, 15, 20, 25, 30, 40, 50, 75, 100, 200, and 300 feet	✓	✓	✓	✓	x	x	B: Black G: Green O: Orange R: Red
2000 Vdc	x	x	x	x	✓	✓	x		✓	✓	✓	✓	x	x	
6000 Vdc	x	x	✓	✓	✓	✓	✓		✓	✓	✓	✓	x	x	
15,000 Vdc	x	✓	x	x	x	x	x		✓	✓	✓	✓	x	x	
20,000 Vdc	✓	x	x	x	x	x	x		x	✓	x	x	x	✓	

Maximum Current Ratings

Magna-Power's DC power cables are offered in 7 different current ratings, which correspond to the wire gauge. Multiple cables may be connected in parallel for increased current capability. Refer to the MagnaDC or MagnaLOAD product diagram for number of available connection points.

All current ratings are specified at 50 °C cable temperature with 25 °C ambient temperature in free air.

The following tables provides the wire gauges corresponding to the specified current ratings:

Max Current Rating	Wire Gauge
3.3 Adc	RG8-U Coaxial Cable
55 Adc	10 AWG (Flexible)
100 Adc	4 AWG (Flexible)
160 Adc	1 AWG (Flexible)
223 Adc	2/0 AWG (Flexible)
310 Adc	4/0 AWG (Flexible)
1000 Adc ¹	Custom Fabricated, 1.25" diameter (Flexible)

¹ 1000 Adc max current rated cable is compatible with T4 termination only

Terminations

Magna-Power offers various terminations for its cables in accordance with the cable ordering guide, above.

The following table defines the available terminations:

Termination	Description	Diagram Representation
T0	None	
T1	1" Stripped	
T2	1/4" Ring Terminal/Lug	
T3	3/8" Ring Terminal/Lug	
T4	Dual 3/8" Ring Terminal/Lug (Cembre CL750-D38)	
T5	Coaxial BNC	

Accessories

Universal Interface Device (UID47)

Magna-Power Electronics UID47 is a general purpose device for connection to Magna-Power Electronics' power supplies. The device contains the necessary circuitry for configuring power supplies for master/slave parallel or series operation.

Master/slave parallel operation allows two or more power supplies to equally share output current when connected together. Master/slave series operation allows two or more power supplies to equally share output voltage when connected together. In either operation mode, the master unit will command the slave units to the proper voltage and current. Each unit will display its own individual voltage and current. Installation requires setting jumpers, placing included 37-conductor cables between the UID47 and power supplies, and wiring the power supply outputs in either parallel or series.

The UID47 can be used as an interface for connecting control and monitoring lines to external circuitry. It also contains an area on the printed circuit board for interconnecting wires and placing components for specific user applications.

Key features of the UID47 option are as follows:

- Compatible with all Magna-Power Electronics power supplies
- Interface for series and parallel master/slave operation
- User configurable screw terminal connector
- Pad area for custom circuitry
- (2) 6-foot 37-pin cables included

Connectors	Master 1: DB-37, Female Master 2: DB-37, Female Slave: DB-37, Female User Interface Circuitry: 10-pin plug connector
Ambient Operating Temperature	-25°C to 50°C
Storage Temperature	-40°C to +85°C
Size	1.24" H x 7.14" W x 4.01" D (3.15 x 18.14 x 10.19 cm)
Weight	0.5 lbs (0.23 kg)

For more detailed information about the UID47, refer to its User Manual.

RS485 (Converter)

The industrial RS232 to Addressable RS485 Converter allows non-addressable, "dumb" RS-232 devices to be connected on an addressable RS-485 network. The master node controls all communications to connected devices. By distributing the switching intelligence along the RS-485 network, wiring cost savings are substantial compared to a single switched "star" configuration.

Devices can either be polled by the master node or request access to the bus through a RS-232 handshake line. This provides a versatile system for interconnecting devices that are designed for point to point communications. Because the units communicate using standard RS-485 signals, RS-232 devices can form their own network or be added to an existing system. Up to 32 nodes at up to 4000 feet can be on one bus without a repeater, and the 485DSS's addressing scheme allows up to 256 units on a single network with repeaters.

USB (Converter)

The industrial RS232 to USB Converter offers instant I/O expansion for peripheral device connectivity. An out-of-the-box (external) alternative to PCI cards, Edgeport makes it easy to add serial port to a PC, server or thin client in minutes without opening the chassis, reconfiguring or rebooting the system.

The USB Converter device plugs directly into the back of the power supply, creating a seamless USB interface. Feature-rich design, reliability and unmatched operating system support make Edgeport USB-to-serial converters ideal for mission-critical enterprise applications. USB cable included along with associated drivers on Magna-Power's website.

Accessories

DBx Module



The DBx Module is a performance-enhancing series-connected add-on module for MagnaDC programmable DC power supplies, delivering ultra-high stability, low ripple, high precision and high accuracy, with voltage, current, and power control modes. The combination of the two products provides a broad range of magnet power supply solutions for high-energy physics and medical applications, including driving dipole, quadrupole, and steering magnets, as well as powering coils to establish stable magnetic fields. In addition, the high power density coupled with the high accuracy and low ripple characteristics make the combined solution ideal for ATE calibration applications.

Low Ripple Performance

The DBx Module Configuration A utilizes three stages of filters to suppress differential line-to-line EMI, common-mode line-to-ground EMI, and power supply ripple from the DC bus.

Internally fabricated common-mode and differential-mode EMI filters are integrated in the DBx Module Configuration A, providing insertion loss as high as 62 dB; typical results shown in the table below.

To filter power supply output ripple voltage, with components that can extend down to the mains power frequency, the DBx Module Configuration A utilizes a linear regulator, with a low DC voltage drop across a series-pass power semiconductor.

The regulator requires two feedback loops: one to maintain a 1.25 Vdc drop across the linear regulator and the second to produce a AC ripple canceling voltage across the series-pass power semiconductor, equal and opposite of the AC ripple voltage at the input. Adding a series connected diodes across the regulator provides protection for current surging and overvoltage transients—a weak point in conventional linear regulators.

Insertion Loss Measurements ¹						
Frequency (MHz)	0.05	0.15	0.50	1.0	10.0	30.0
Differential Mode (dB)	41.0	58.7	46.3	62.7	55.1	50.5
Common Mode (dB)	30.0	47.0	57.4	67.6	56.4	25.4

Key Facts

- Add-on module for MagnaDC power supplies
- Available from 1.5 kW to 3,000 kW+
- < 10 ppm stability (A1, B1 Configuration)
- Up to 24-bit resolution
- Up to 10x output ripple reduction
- Current ratings up to 6,000 Adc, Systems up to 10,000 Adc
- Voltage ratings up to 1,000 Vdc
- Voltage, current, and power control

Ultra-Stable, High Accuracy, and High Resolution

An ultra-stable fluxgate direct-current current transformer (DCCT) is used to take high accuracy isolated measurements from a series connection with the power supply's DC output. This ultra-stable transducer, combined with the DBx Module's low temperature drift resistors and temperature stabilized digital programming circuit, provides highly granulated programming (18-bit) and readback (24-bit), and enables enhanced long-term stability. Critical components are carefully laid out within a specially designed temperature compartment to accelerate the time to temperature stabilization.

Setup and Control

DBx Module Configurations A1 and B1 are provided with copper bus bars with threaded inserts for the DC input and DC output connections. In these configurations, the DC power supply output connects to the DBx Module's DC input and all current sensing is done internal to the DBx Module. The load / device under test gets connected to the DBx Module's DC output bus bars. DBx Module Configuration C1 uses an external 19" panel-mounted DCCT with a control signal providing feedback to the DBx Module via its external user I/O connector and bus bars for the user to make the load connection. In all configurations, so that the DBx Module can control the power supply, a provided cable connects the DBx Module's interface connector to the power supply's JS1 37-pin external user I/O connector.

Digital programming of set points, trip points, and slew rates are performed using the DBx Module via front panel knob or keypad, front panel up-down arrows for highly granular single-bit control, or using the computer interface connections via provided MagnaWEB software or user defined software using SCPI commands. Included communication interfaces include RS485 and USB with optional TCP/IP Ethernet.



DBx Module rear view with DC input and DC output covers removed

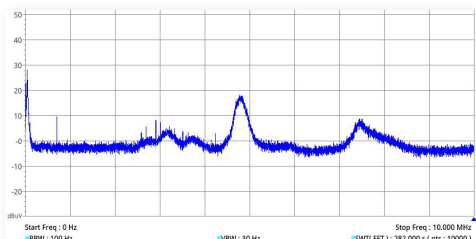

Differential mode noise on DC output without DBx Module

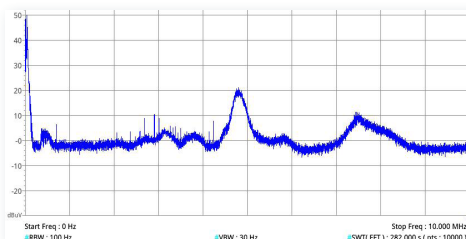

Common mode noise on DC output without DBx Module

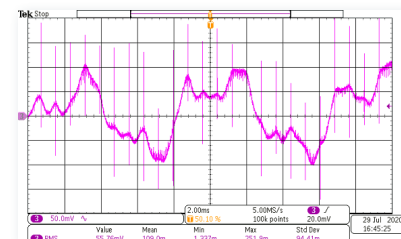

Voltage ripple on DC output without DBx Module

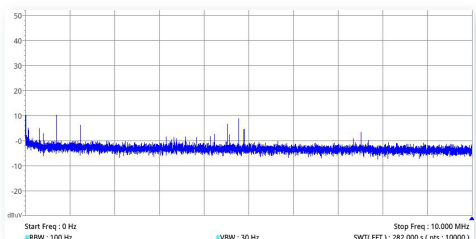

Differential mode noise on DC output with DBx Module¹

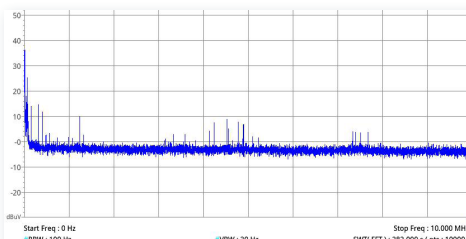

Common mode noise on DC output with DBx Module¹

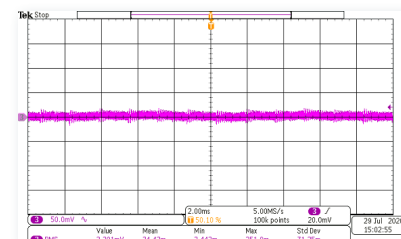

Voltage ripple on DC output with DBx Module¹

DBx Module (Continued)

Configurations

The DBx Module is offered in three different configurations—A1, B1, and C1—differing in maximum current capability and internal stages.

The DBx Module **Configuration A1** contains all stages, including the linear regulator, differential- and common-mode DC EMI filters, temperature-stabilized ultra-high stability controller, and DCCT. Configuration A occupies a 1U (1.75" high) rack-mount enclosure and is available for voltages from 10 Vdc to 1,000 Vdc and three different max current ratings, at 37.5 Adc, 75 Adc and 150 Adc.

The DBx Module **Configuration B1** is intended for applications that do not require additional DC filtering and contains only the temperature-stabilized ultra-high stability controller and DCCT. Configuration B occupies a 1U rack-mount enclosure and is available for voltages from 10 Vdc to 1,000 Vdc and three different max current ratings, at 37.5 Adc, 75 Adc and 150 Adc.

The DBx Module **Configuration C1** is intended for high-current applications, where the 1U rack-mount enclosure contains only the temperature-stabilized ultra-high stability controller, with a provided external 19" panel mounted DCCT that ties into the DBx Module through a rear connector. Configuration C is available for voltages from 10 Vdc to 1,000 Vdc and max current ratings from 500 Adc to 10,000 Adc.

Available Configurations

Config	EMI/Ripple Filter	High Stability, Precision, Accuracy	Max Voltage Rating Available	Max Current Rating Available	Form Factor
A1	✓	✓	10 Vdc to 1,000 Vdc	37.5, 75, or 150 Adc	1U Enclosure
B1	✗	✓	10 Vdc to 1,000 Vdc	37.5, 75, or 150 Adc	1U Enclosure
C1	✗	✓	10 Vdc to 1,000 Vdc	500, 750, 1500, 3000, 5000, or 10000 Adc	1U Enclosure + External Transducer

Model Ordering Guide

DBx Module models are defined by the configuration type and number (see "Available Configurations" table), the maximum voltage rating, and the maximum current rating. Any voltage from Magna-Power's standard MagnaDC power supply offering is available, from 10 Vdc to 1,000 Vdc. The DBx Module resolution step size and calibration is a function of its maximum ratings, therefore it's recommend to specify a model most closely matched to the requirement.

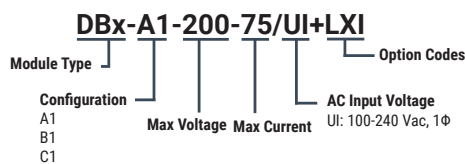

DBx Module right side view (top) and left side view (bottom)

Specifications

Performance Specifications

Stability, A1 and B1 Configuration Voltage or Current Control	< 10 ppm; long-term drift (8 hr) Measured FWHM
Stability, C1 Configuration Voltage or Current Control	< 50 ppm; long-term drift (8 hr) Measured FWHM
Temperature Coefficient Voltage Control	< 0.05 ppm/°C
Temperature Coefficient Current Control	< 0.5 ppm/°C
Programming Resolution	18-bit
Measurement Resolution	24-bit
Programming Accuracy	± 0.04%; voltage control ± 0.04%; current control
Rise/Fall Time Maximum	Voltage Mode: 6 s, 10% to 90% max voltage Current Mode: 6 s, 10% to 90% max current Power Mode: 6 s, 10% to 90% max power
Power Loss Configuration A1 Only	Current output x 1.5 volts

Connection Specifications

AC Input 1Φ, 2-wire + ground	100-240 Vac, IEC 60320 C13 receptacle
DC Input (A1, B)	Bus bars with 3/8" threaded insert; 250 Adc max
DC Output	Bus bars with 3/8" threaded insert; 250 Adc max
Communication Interfaces (Standard)	USB Host (Front): Type B USB Host (Rear): Type B RS485 (Rear): RJ-45 External User I/O: 25-pin D-Sub, female
Communication Interfaces (Optional)	LXI TCP/IP Ethernet (Rear): RJ-45

Physical Specifications

Size and Weight Configuration A1 and B1	1U 1.75" H x 19" W x 24" D (4.4 x 48.3 x 61.0 cm) 35 lbs (15.88 kg)
Size and Weight Configuration C1	1U (See Above) + External Transducer External transducer size and weight will vary depending on current rating

Environmental Specifications

Ambient Operating Temperature	0°C to 50°C
Storage Temperature	-25°C to +85°C
Humidity	Relative humidity 30% to 90%, non-condensing
Air Flow	Side intake, rear exhaust

Regulatory Compliance

EMC	Complies with 2014/30/EU (EMC Directive) CISPR 22 / EN 55022 Class A
Safety	Complies with EN61010-1 Complies with 2014/35/EU (Low Voltage Directive)
CE Mark	Yes
RoHS Compliant	Yes

BDx Module



High-power rack-mount blocking diode solution

For applications or products where the Integrated Blocking Diode (+BD) option is not available or desired, the BDx Module offers a turn-key rack-mount blocking diode solution, including:

- Fully integrated and enclosed heatsinking and fan cooling
- User I/O status feedback including a temperature alarm state
- Front panel status indicator
- Heavy-duty tin-plated copper bus bars
- Remote sensing terminal for voltage feedback compensation
- Universal single phase active-PFC AC input connection

Internally, semiconductors are secured to Magna-Power manufactured heatsinks with fans and integrated thermocouples. An internal microprocessor monitors the internal temperature and provides +5V digital output signal when the system is powered and in a normal operating state. This +5V signal can be easily integrated into interlock systems, to ensure power is only driven through the BDx Module when its powered on and cooling is functional. Additional, a +5V digital input allows control of when the BDx Module is turned off and on, providing complete integration with a connected power supply.

Specifications

AC Input Specifications

AC Input 1Φ, 2-wire + ground	100-240 Vac, IEC 60320 C13 receptacle
AC Input Frequency	50-60 Hz
AC Input Isolation	±1500 Vac, maximum input voltage to ground

Physical Specifications

Racking Standard	EIA-310
Rear Support Rails	Included
Size and Weight Configuration A1	1U 1.75" H x 19" W x 24" D (4.4 x 48.3 x 61.0 cm) 35 lbs (15.88 kg)

Environmental Specifications

Ambient Operating Temperature	0°C to 50°C
Storage Temperature	-25°C to +85°C
Humidity	Relative humidity 30% to 90%, non-condensing
Air Flow	Side intake, rear exhaust

Regulatory Compliance

EMC	Complies with 2014/30/EU (EMC Directive) CISPR 22 / EN 55022 Class A
Safety	Complies with EN61010-1 Complies with 2014/35/EU (Low Voltage Directive)
CE Mark	Yes
RoHS Compliant	Yes

Key Facts

- Add-on module for MagnaDC power supplies
- 4 models addressing broad range of applications
- Protection up to 1,200 Vdc
- Forward current up to 1,200 Adc
- Fully integrated cooling with status indicator
- Power supply user I/O controls interface
- Included fixed rail rack-mount kit



Back EMF Protection

Prevent back-electromotive force (EMF) from electric motors or from the connection of charged batteries and capacitors from flowing back into the output of your power supply.



High Voltage Protection

Protect your power supply and other DC power equipment from externally generated DC bus voltages that could exceed the equipment's maximum ratings.



Mixed Voltage Paralleling

Connect multiple power supplies with different voltage ratings in parallel and protect lower voltage products high bus voltages.



Prevent Load Discharge

Prevent the power supply's internal bleeder network from discharging batteries, capacitors or fuel cells when the power supply is standby, faulted state, or turned off.

Model Ordering Guide

BDx Module models are defined by the configuration type and number, the maximum DC input voltage rating, and the maximum current rating.

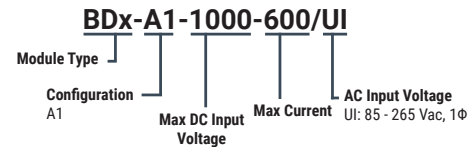

Model	Config	Max DC Input Voltage	Max Current	Reverse Voltage Rating	Typical Losses
BDx-A1-1000-300/UI	A1	1000 Vdc	300 Adc	1200 Vdc	Up to 1.4%
BDx-A1-150-600/UI	A1	150 Vdc	600 Adc	200 Vdc	Up to 2.5%
BDx-A1-1000-600/UI	A1	1000 Vdc	600 Adc	1200 Vdc	Up to 1.4%
BDx-A1-150-1200/UI	A1	150 Vdc	1200 Adc	200 Vdc	Up to 2.5%

External User I/O Specifications

External User I/O Port	15-pin D-sub DB-25, female See User Manual for pin layout
Digital Output Voltage System Status	+5V when systems normal. 0V when off or faulted state. Connected to MagnaDC interlock input via provided cable.
Digital Input Voltage Enable	+5V to engage cooling fans. 0V to disable product. Connected to MagnaDC power status output via provided cable.
Remote Sense	6-32 screw connection for positive terminal

Photovoltaic Power Profile Emulation Software

Intuitive Solar Emulation Software • 1.5 kW to 3000 kW+

Introduction

The Photovoltaic Power Profile Emulation (PPPE) software automatically calculates solar array voltage and current profiles based on user-defined parameters. These profiles can be sequentially sent to a Magna-Power Electronics power supply, which will emulate defined characteristics. The user can define a limitless number of profiles to be emulated and sequenced over a given time period.

Design and production validation for photovoltaic connected electronics requires a photovoltaic emulating power source with flexible output characteristics. Inverters and specialized DC-DC converters employ maximum power point tracking (MPPT) control algorithms to maximize utilization of nonlinear energy sources, such as solar panels and wind turbines. For development and manufacturing, using photovoltaic arrays for validation is costly with uncontrolled source characteristics. By utilizing a power supply with user-programmable output characteristics, the user can evaluate the full range of power conditions.

After the profile is defined, it can be transferred to the power supply for either static or dynamic emulation. A time dependent parameter defines how long the power supply should emulate that profile before loading the next profile in the sequence.

Modeling and Operation

A profile is a voltage/current curve that the power supply's output should emulate. There are three methods to generate a power profile in the PPPE software:

Automatic, based on solar array parameters

The user selects the desired solar panel technology, nominal temperature, irradiance, voltage and current values. Each V-I profile is then defined only by new temperature and irradiance values. The rest of the parameters: maximum power point (V_{mp} , I_{mp}), open circuit voltage (V_{oc}), and short circuit current (I_{sc}); are all calculated automatically in accordance with the EN50530 standard.

Automatic, based on 4-parameters

The user defines the maximum power point (V_{mp} , I_{mp}), open circuit voltage (V_{oc}), and short circuit current (I_{sc}). The profile is then generated based on these parameters.

Manual

The user defines up to 50 current and voltage points for the power supply to emulate. The power supply performs a piecewise linear approximation between points to provide a smooth output curve.

Key Features

- Automatic voltage current profile calculation from reference parameters
- Autosequencing through power profiles, at user-defined rate
- Graphical profile view and real-time output with advanced graphical viewer panel
- Compatible with all Magna-Power MagnaDC programmable DC power supplies with modulation capability
- EN50530 V-I curve generation model
- Curve interpolation for smooth transitions
- SCPI command export for solar emulation functionality in LabVIEW
- Data logging
- Curve import and export

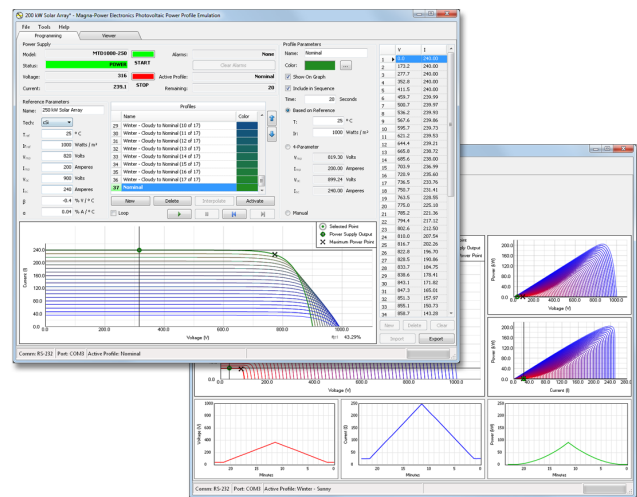

Magna-Power Electronics Photovoltaic Power Profile Emulation (PPPE) software: main programming window (foreground); Viewer window (background)

Advanced Features

Magna-Power Electronics worked closely with solar inverter manufacturers to refine the PPPE feature-set. Some of the key advanced PPPE features are as follows:

EN50530 Modeling

The European EN50530 standard provides a new algorithm for proper solar array modeling. PPPE 2.0 incorporates this model, furthermore allowing the selection of thin film or polycrystalline silicon parameters. Defining a curve is as simple as specifying desired open-circuit voltage, short-circuit current, and maximum power point. Alternatively, manual parameters can be entered for more customized modeling or profile importing from an external file.

Live Output Viewer

A new live output viewer provides six graphs of instantaneous output parameters versus time. This data allows the user to visualize fluctuations in voltage, current, and power over time.

Curve Interpolation

An interpolation function was added to automatically generate transitional curves. This functionality enables smooth transitions from one curve to another over a user-defined period of time.

Data Logging

Customizable data logging functionality was added, allowing for report generation and data analysis using external tools. Data is exported to a comma-delimited (.csv) file.

Command Export

Leverage the ease of profile generation in PPPE and export the generated SCPI commands for integration into a separate programming environment, such as LabVIEW/LabWindows.

The following figure provides the voltage error as a function of operating bandwidth during solar array emulation:

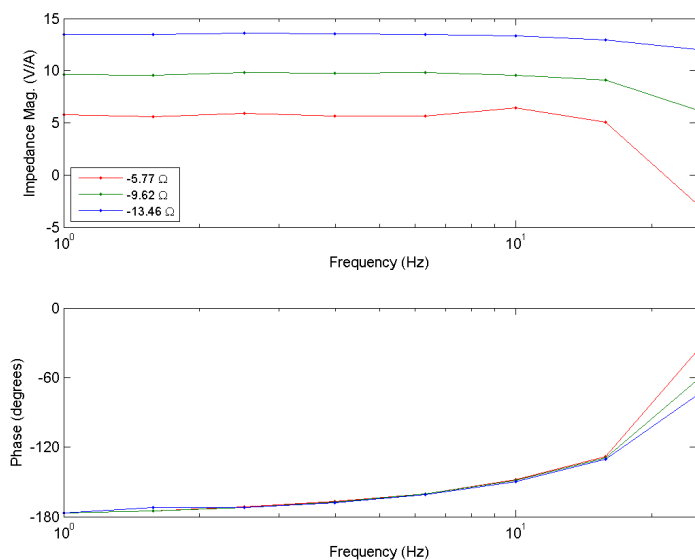

PPPE Operating Specifications

Bandwidth	With High Slew Rate Output (+HS) Option: 15 Hz Standard Models: 2 Hz
Communication Interfaces Supported	RS232, LXI TCP/IP Ethernet, IEEE 488 GPIB, USB
Minimum Time Between Sequential Profiles	2
Number of Profile Sequences	Unlimited
Minimum Voc and Isc	10% of the power supply's rated voltage and current
Maximum Profile Slope	$(\Delta I / \Delta V) \times (I_{max} / V_{max}) \leq -0.05$
Instantaneous Load Change to Short-circuit	Supported with High Slew Rate Output (+HS) option



1.5 MW solar array emulator using Magna-Power MT Series power supplies at the National Renewable Energy Laboratory in Golden, Colorado USA

Overview of Current-Fed Power Processing

Switching power supplies in the tens of kilowatt power range have been slowly replacing traditional silicon controlled rectifier (SCR) based topologies over the past several decades. The advantages and disadvantages are well known. High frequency operation of switching power supplies enables magnetic components to be reduced in size and weight and allows faster response times to line and load perturbations. The principle disadvantage is that the demands placed on switching devices tend to make high power switching power supplies less reliable than their SCR based counterpart.

Numerous power circuit topologies are currently being deployed for high-power switchmode applications. The most common configurations consist of three power conversion stages:

- An AC to DC converter which converts the 3-phase incoming mains to a DC voltage.
- A DC to AC inverter or converter which converts the voltage on the DC bus to a high-frequency AC voltage.
- A secondary AC to DC converter which converts the high-frequency AC voltage to DC voltage.

The two AC to DC converters are very similar in function except for the operating frequencies; the converters consist primarily of rectifiers, low pass filters, and snubbers. The snubbers limit switching transient voltages and absorb energy stored from parasitic components. The second stage, the DC to AC converter, generates a high-frequency voltage which drives a transformer at a frequency generally at 20 kHz or above. The transformer is required for ohmic isolation and production of an output voltage as determined by the transformer turns ratio. The DC to AC converter is the most complex stage and there are numerous power processing topologies presently in production.

Most high-power DC to AC converters utilize a H-bridge configuration, four power devices, for exciting the high-frequency transformer. The H-bridge is controlled with pulse width modulated (PWM) or with other modulation strategies to produce a voltage of limited pulse width or amplitude. Modulation of the H-bridge produces a controllable output voltage.

DC to AC converter topologies fall into three groups: hard-switched converters, soft-switched converters, and resonant converters. The primary difference between the topologies is the switching device's load line during the commutation period (switching transition). It is during the commutation period where power devices dissipate the most power.

Hard-switched converters allow the power devices and/or snubbers to absorb commutation energy. Soft-switched converters have additional passive circuitry to shape power waveforms to reduce losses during the commutation period. The advantage of reduced commutation losses is offset with increased circuitry complexity, additional on-state losses (due to waveform modification), and sensitivity to loading conditions. Resonant power converters have highly tuned tank circuits which cause either device voltage or current to appear sinusoidal. The advantages and disadvantages are similar to soft-switched converters. Resonant power converters are second-order and timing is more critical than soft-switched converters.

Hard-switched, soft-switched, and resonant converters are usually designed to operate from a DC voltage source and are commonly referred to as voltage-fed converters. Characteristically, voltage-fed converters are prone to shoot through problems which can occur when one device fails to turn off before the other series connected device turns on. While protective circuitry can be designed to minimize catastrophic problems, generally, such protective circuitry must be effective to detect shoot through problems in one to two microseconds. Variation of device parameters and abnormal modulation of voltage-fed converters can cause half-cycle voltage imbalance which can result in transformer core saturation. Protective circuitry must also have a response to detect these conditions before damage can occur in the power semiconductors.

Current-fed power converters [1]-[3], the electrical dual of voltage-fed converters, is still another, but less known and used,

power circuit alternative for power conversion. The advantage of these power converters over their voltage-fed counterpart is that shoot through and half cycle symmetry cannot cause device failure or core saturation. This is characteristic of SCR based converters and one of the main reasons why current-fed converters tend to be more robust. The main disadvantage of current-fed converters is that a fourth power conversion stage is required to convert the DC bus voltage to a DC current. While the added stage results in additional complexity and losses, the power conversion stages can be made to work more efficiently. Current-fed power converter topologies are implemented less than voltage-fed converters primarily because of cost.

This article describes the differences between voltage-fed and current-fed converters and the sensitivities to conditions causing power semiconductor stress. Issues for implementing the fourth power conversion stage, the voltage to current converter, are also discussed.

Characteristics of Voltage-Fed Converters

A simplified schematic of a voltage-fed converter is illustrated in Figure 1. The converter consists of a H-bridge, insulated gate bipolar transistors (IGBT) Q1 through Q4, power transformer T1, and output rectifier diodes D5 through D8. The input voltage source can be a battery, DC power supply, or rectified AC bus. For practical reasons, capacitor C1 is required to ensure a low impedance bus at higher frequencies. Inductor L1 and capacitor C2 form a low pass filter that removes the AC components on the output.

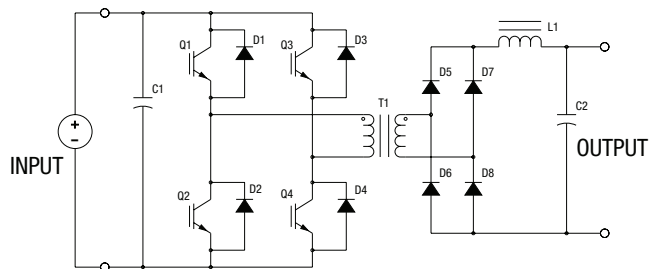

Figure 1. Voltage-Fed Converter

With conventional, hard-switched, PWM modulation schemes, Q1, Q4 conduct for a fraction of a half-cycle and Q2, Q3 conduct for a fraction of the other half-cycle. This excites transformer T1 equally on alternate half-cycles. Averaging the rectified voltage on the secondary side of the transformer produces a DC output voltage that is proportional to the conduction period of the IGBT's.

Timing on voltage-fed converters is critical. If IGBT's Q1, Q2 or Q3, Q4 conduct simultaneously, current rapidly rises in the conducting devices leading to device failure in microseconds. To prevent this critical operating condition, designers introduce turn-on delays in the modulation schemes, monitor DC bus currents, and sense on-state conditions of the power devices. The challenge of successfully implementing these protective schemes is that circuitry must be both responsive to high speed faults and insensitive to electrical noise. This is a formidable challenge especially when power levels are on the order of tens of kilowatts.

A secondary issue with voltage-fed converters is the production of DC voltages with variations of on-state voltages, variations with rise and fall times, and erroneous switching states. Exciting a transformer with DC voltage causes core saturation and power device failure as previously described. Typical methods to circumvent catastrophic events are the placement of air gaps in the transformer, placement of DC blocking capacitors in series with the transformer primary winding, and deploying current mode modulation for cycle by cycle current balancing.

Characteristics of Current-Fed Converters

Current-fed converters are the electrical dual of voltage-fed converters. As illustrated in Figure 2, current-fed converters consist of a H-bridge, IGBT's Q1 through Q4, power transformer T1, and

output rectifier diodes D5 through D8. The input current source has to be created with additional power electronic circuitry. For practical reasons, inductor L1 is required to ensure a high impedance bus at higher frequencies. Unlike a voltage-fed converter, the output filter consists of a single component, capacitor C1.

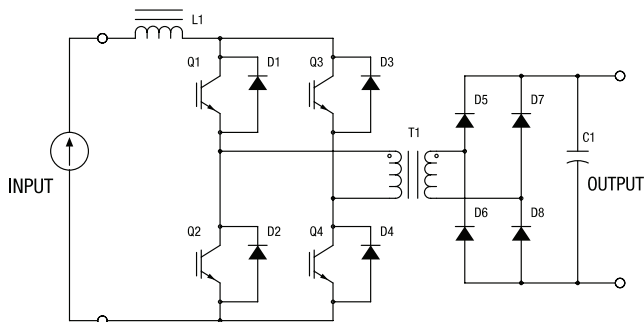

Figure 2. Current-Fed Converter

Current-fed converters operate in a mode where voltage and current waveforms are transposed from that of voltage-fed converters. Operation requires IGBT's Q1 through Q4 to be PWM modulated, but in this case, with the constraint that Q1, Q3 or Q2, Q4 are never allowed to be simultaneously placed in a non-conducting state. The constraint ensures the input impedance of the H-bridge is always finite; otherwise, a current source feeding into an open current would produce a destructive high voltage. (As should be noted, constraints placed on switching states and conditions of abnormal operation are the electrical dual of the voltage-fed topology.) Averaging the rectified current on the secondary side of the transformer produces a DC output current that is proportional to the conduction period of the IGBT's.

Transformer T1, being excited with a current PWM waveform, is basically insensitive to variations of on-state voltages, variations with rise and fall times, and erroneous switching states. With current-fed converters, core saturation can be prevented as long as the ampere-turn excitation is within the bounds of normal operation even if the current is DC.

The disadvantage of current-fed converters is the fact that current sources are not commonly available and such sources must be created from a voltage source. Deployment of buck converters or choppers is an obvious choice because of their very efficient use of power semiconductors. With this extra power conversion stage, control can be placed in the current-fed converter, chopper, or both. Figure 3 shows a high-power converter with a 3-phase input rectifier, chopper, current-fed converter, and output rectifier.

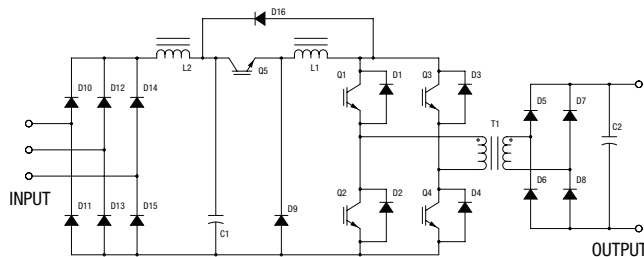

Figure 3. Rectifier, chopper, and current-fed converter

The novel feature of the current-fed converter combined with an input chopper is its performance under abnormal operating conditions. Transformer T1, IGBT's Q1 through Q5, and diodes D1 through D8 can all operate in a shorted state with system level protection. Under such conditions, the rate of rise of current is a function of the applied voltage across inductor L1 divided by its inductance. Inductor L1 is typically sized to maintain a peak to peak ripple current within a fraction of its maximum value. As long as system shutdown occurs within the switching period of the chopper, peak currents are well controlled. Permitting an extended fault detection period allows fault protection circuitry to be well

filtered enabling robust, nuisance free tripping operation in high electrical noise environments.

Another key feature of the chopper and current-fed converter combination is that each circuit can protect each other from abnormally high currents with a single detecting scheme. A fault in the converter stage can be protected with the chopper shutdown and a fault in the chopper stage can be protected with the current-fed converter shutdown.

The previous constraints placed on the switching states of the current-fed converter can be circumvented with the introduction of catch diode D16. This component provides a current return path for IGBT's Q1, Q3 or Q2, Q4 when the devices are turned off. Diode D16 clamps the maximum off state voltage of the H-bridge to the voltage across capacitor C1.

Conclusion

This article describes the general characteristics of high power voltage-fed and current-fed converters and their sensitivity to device parameter variations and erroneous switching states. Voltage-fed converters generally have series connected power devices across an input capacitor. Abnormal switching states can permit simultaneous device conduction causing currents to increase very rapidly. In addition, voltage-fed converters can also produce DC offsets which can cause the magnetic core of the main transformer to saturate. To protect power semiconductors under these conditions, high speed fault detection is required. The protection of power semiconductors in high, electrical noise environments is difficult.

Current-fed converters are the electrical dual of voltage-fed converters and prefer a shorted state to an open state of operation. These topologies cannot create fast rising current spikes and cannot cause magnetic core saturation under erroneous conditions. Current-fed converters operate with the robustness of SCR based power supplies, but at high-frequency. Current-fed converters require an additional power processing stage which can be used for control and enhanced system protection.

References

- [1] A. I. Pressman, *Switching Power Supply Design - Second Edition*, New York, NY: McGraw-Hill, 1998.
- [2] P. Wood, *Switching Power Converters*, New York, NY: Van Nostrand Reinhold Company, 1981.
- [3] D. W. Shimer, A. C. Lange, J. N. Bombay, "A High-Power Switch-Mode DC Power Supply for Dynamic Loads," presented at the IEEE-IAS Annual Meeting, Oct. 1994.