

SLx SERIES

Programmable DC Power Supply

MODELS

171

CONFIGURATIONS

53,000+

POWER LEVELS

1.5 kW, 2.6 kW, 4 kW, 6 kW, 8 kW, and 10 kW in 1U



Introducing to the SLx Series

Building on over 40 years of power supply innovation and with over 26,500 different model configurations, the SLx Series is Magna-Power's most versatile programmable DC power supply series ever created. The SLx Series offers models at 6 different power levels, with a highly granular range of voltages and currents. With industry-leading leading power density, rugged current-fed power processing, and the state-of-the-art MagnaLINK™ distributed DSP digital control architecture, the SLx Series meets the long-term DC power requirements of research & development, industrial automation, and process control applications.

Key Features

- Voltage, current, and power control
- Rugged current-fed power processing
- 16-bit precision with single bit control
- SCPI and Modbus command sets
- Programmable protection features
- Interlock and hardware emergency stop
- Slew rate control
- Continuous full power operation up to 50°C ambient
- Configurable analog-digital 26-pin I/O port
- Digital-hybrid MagnaLINK™ master-slaving
- Local, remote, and leadless voltage sensing
- USB (front and rear) and RS485 interfaces
- CAN, EtherCAT, EtherNet/IP, LXI TCP/IP Ethernet, ModbusTCP, and PROFINET fully integrated communications options available
- MagnaCTRL software platform included
- Made in the USA

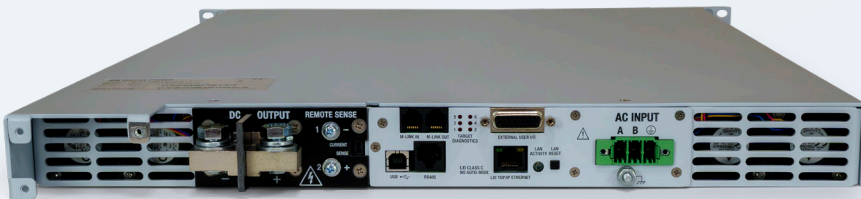

Rear panel of a 2.6 kW SL Series power supply with 1-phase UI2 input and the output cover removed.

Building on Over 40 Years of Power Supply Innovation

MagnaLINK™ Distributed Digital Control

Magna-Power developed its MagnaLINK™ digital control platform from the ground up to utilize an array of four Texas Instruments DSPs distributed across various internal assemblies. High-speed board-to-board communications is achieved between DSPs utilizing an internally developed low-level communication protocol. A custom bootloader ensures long-term support with multi-target firmware updates and synchronization. New capabilities are achieved with the MagnaLINK digital architecture, some of which include: slew rate control, gain modification, 16-bit precision, 100 ppm stability, user-defined sequencing and function generation, and digital hybrid master-slaving.

Reliable Current-Fed Power Processing

All MagnaDC programmable DC power supplies utilize high-frequency IGBT- and MOSFET-based power processing in a current-fed topology. This topology adds an additional stage over the conventional voltage-fed topology for enhanced control and system protection, ensuring that even under a fault condition, the power supply will self-protect. Due to the self-protecting characteristics of this topology, the possibility of fast rising current spikes and magnetic core saturation is eliminated. This topology coupled with state-of-the-art Silicon Carbide (SiC) power semiconductors enables the SLx Series to deliver class-leading power density, reliability, and efficiency with continuous full-power operation up to 50°C ambient.

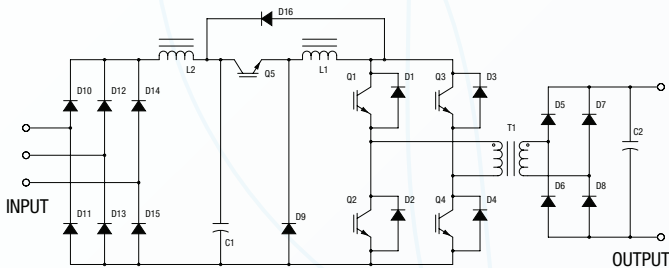

Simplified topology diagram for Magna-Power's current-fed power processing

Intuitive, Bright, Long-Lasting Front Panel Interface



Prioritizing brightness and reliability, the SLx Series features of a hybrid display with bright green segments for voltage and current output and a multi-line display for power measurement, settings configuration, and status messages. A black-anodized machined aluminum control knob enables precise dialing of control set points, while a 10-digit key and arrow buttons provide digital set point inputs with 16-bit precision. In addition, a dedicated Lock button enables users to lock out the front panel to prevent unwanted changes from the front panel. Easily connect a computer to the SLx Series without going behind it by using the front panel USB port; a rear-mounted USB port is also provided.

Plug & Play Master-Slaving

The SLx Series includes Magna-Power's next-generation digital hybrid master-slaving interface via dual digital MagnaLINK communication ports. With support up to 12 units in a master-slave set, users can easily expand their current capability by adding more units in parallel. A secondary current sense connection is provided, which provides real-time analog current feedback to the master, enabling reliable, high-accuracy measurement aggregation to a single display.

Standard Safety Features with Emergency Stop

The SLx Series features a soft-start circuit to eliminate large peak in-rush currents from the AC mains, ensuring AC current draw never exceeds the current draw at full load. The SLx Series programmable DC power supplies have extensive safety and diagnostic functions, including:

- AC Phase Loss
- Over Voltage Trip (Programmable)
- Over Current Trip (Programmable)
- Over Power Trip (Programmable)
- Cleared Fuse
- Over Voltage on Program Line Input
- Over Temperature on Internal Heatsink or Output Capacitors
- Internal Communications Fault
- Interlock and Emergency Stop Fault

When a fault is detected, the power supply immediately shuts down power processing circuit, utilizing the immediate one-shot trip (OSHT) zone event for inverter PWM channels. Users can easily identify faults using the Status message display or by SCPI/Modbus commands.

Finally, both interlock and emergency stop features are included as standard. The interlock feature provides a 5V interlock input, which when coupled with the provided 5V reference signal, allows for a dry contact to easily trigger a latching interlock fault, while maintaining control power. A separate emergency stop feature bypasses all logic and processors to provide a hardware-only path to easily interrupt AC power to the SLx Series power supply with a 24V signal, providing a full hardware shutdown.

Target Diagnostics for Easy Field Servicing

The SLx Series introduces Magna-Power's Target Diagnostics feature, mapping the status LEDs for every major assembly to a rear mounted LED matrix. This LED matrix provides the statuses of each internal assembly, easily allowing users or support teams to understand faults or configuration issues, while keeping products mounted and covers on. The Target Diagnostics feature coupled with MagnaCTRL's EPROM editor offers a robust suite of remote support tools to effectively reduce downtime.

Made in the USA, Available Worldwide

MagnaDC programmable DC power supplies are designed and manufactured at Magna-Power's 73,500 sq-ft vertically integrated USA manufacturing facility in Flemington, New Jersey. From raw materials to the completed product, Magna-Power has insourced nearly the entire production process to maintain complete control of quality, cost, and build-time. Heat-sinks and various metal assemblies are machined through both automated CNC and EDM. Sheet metal is cut, punched, sanded, bent, and powder coated in-house. Magnetics are wound-to-order from validated designs based on a model's voltage and current. A full surface mount technology (SMT) with multiple stages of 3D automated optical inspection ensures high-quality printed circuit board assemblies. Finally, after assembly, products undergo comprehensive test and calibration, followed by an extended burn-in period.

Products are sold directly from the factory and through distribution, with a service network around the world.



Ultimate Programming Flexibility

Communication Interfaces for Industrial Control

SLx Series power supplies come standard with Dual USB (front and back) and RS485. Options are available to provide seamless fully integrated communication for either traditional TCP/IP network control or through direct control over industrial communication interfaces using Modbus or SCPI commands. Magna-Power has taken significant measures to ensure comprehensive command-set support and documentation across the following optional interfaces:

- CANopen (+CAN)
- EtherCAT (+ECAT)
- EtherNet/IP (+EIP)
- LXI TCP/IP Ethernet (+LXI)
- Modbus-TCP (+MTCP)
- PROFINET (+PROF)



Configurable User I/O for Analog & Digital Controls

All SLx Series power supplies come standard with a 26-pin D-Sub connector designated as the External User I/O. This connector provides:

- 8 Digital Outputs (5V logic)
- 4 Digital Inputs (5V logic)
- 4 Analog Outputs (0-10V logic)
- 4 Analog Inputs (0-10V logic)

The External User I/O is isolated from the output terminals and referenced to earth ground. The connector's pins are user configurable, allowing users to select the functions needed in their application, while providing future capability for new features. Use the digital outputs to integrate the power supply with, for example, external enable signals or digital fault monitoring logic, or monitor voltage-current using the analog 0-10V outputs. A dedicated high-speed analog input is also provided, sampled at 2 kHz for near real-time control.

Software Integration with Ease

With standard support for Standard Commands for Programmable Instrumentation (SCPI) and Modbus, SLx Series power supplies provide an easy-to-use API with well-documented commands in readable text. Over 60 commands allow programmatic access to product registers, starting and stopping the product, control of voltage, current and power, slew rate control, high-accuracy measurement queries, and product configuration. Simple scripting or complex software can be achieved, with extensive documentation and examples provided by Magna-Power.

```
import serial
magnaPower = serial.Serial(port='COM4', baudrate=115200)
magnaPower.write('*IDN?\n'.encode())
print magnaPower.readline()
magnaPower.write('VOLT 0\n'.encode())
magnaPower.write('CURR 0\n'.encode())
magnaPower.write('OUTP:START\n'.encode())
magnaPower.write('VOLT 270\n'.encode())
currSetPoints = [50, 100, 150, 250]
for currSetPoint in currSetPoints:
    print 'Setting Current to %s A' % currSetPoint
    magnaPower.write('CURR {0}\n'.format(currSetPoint).encode())
    magnaPower.write('MEAS:VOLT?\n'.encode())
    print magnaPower.readline()
    time.sleep(20)
magnaPower.write('OUTP:STOP\n'.encode())
magnaPower.close()
```

Basic Python programming example using SCPI commands over RS485 to sequence through an array of current set points.



SLx Series Model Ordering Guide

Over 26,500+ configurations of SLx Series models are available, based on AC input voltage, DC output ratings, and integrated options. The following model ordering guide and models table provides the available SLx Series ratings and model configuration guidance.

SLx10-800-12.5/480+ECAT

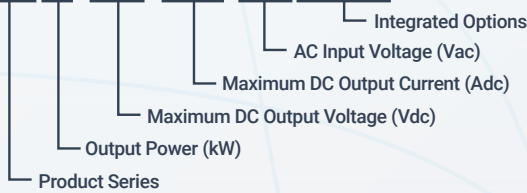

Rear protective output cover included with all units with adjustable fiberglass reinforced thermoset polyester insulator to securely clamp around wires.

Max Voltage (Vdc)	Output Power (kW)						Ripple (mVrms)	Efficiency
	1.5 kW	2.6 kW	4 kW	6 kW	8 kW	10 kW		
5	250	500	600	N/A	N/A	N/A	30	84%
10	150	250	400	600	N/A	N/A	30	89%
16	93	162	250	375	500	600	40	89%
20	75	130	200	250	400	500	40	90%
25	60	104	160	240	320	400	50	91%
32	46	81	125	186	250	310	60	91%
40	37	65	100	150	200	250	80	91%
50	30	52	80	120	160	200	70	92%
60	25	43	66	100	133	166	100	93%
80	18	32	50	75	100	125	120	93%
100	15	26	40	60	80	100	120	93%
125	12	20	32	48	64	80	110	93%
160	9	16	25	36	50	60	110	93%
200	7.5	13	20	30	40	50	110	94%
250	6	10.4	16	24	32	40	110	94%
300	5	8.6	13.2	20	26.4	33.3	160	94%
375	4	6.9	10.4	16	21.3	26.5	160	94%
400	3.7	6.5	10	15	20	25	170	95%
500	3	5.2	8	12	16	20	250	95%
600	2.5	4.3	6.4	10	13.3	16.5	250	95%
800	1.8	3.2	5	7.5	10	12.5	350	95%
1000	1.5	2.6	4	6	8	10	400	95%
1250	1.2	2	3.2	4.8	6.4	8	700	95%
1500	1	1.7	2.6	4	5.3	6.6	1000	95%
2000	0.75	1.3	2	3	4	5	6500	95%
2500	0.6	1	1.6	2.4	3.2	4	7500	95%
3000	0.5	0.86	1.3	2	2.6	3.3	8500	95%

Available AC Input Voltages

Available on 1.5 kW Models

- **UI** (100-240 Vac, 1-phase)

Available on 2.6 kW Models

- **UI2** (208-240 Vac, 1-phase)

Available on All Models

- **208** Vac, 3-Phase
- **240** Vac, 3-Phase
- **380/400** Vac, 3-Phase
- **415** Vac, 3-Phase
- **440** Vac, 3-Phase
- **480** Vac, 3-Phase

Available Integrated Options

Hardware

- Ruggedized **+RUG**
- Water Cooling **+WC**

Communications

- CANopen **+CAN**
- EtherCAT **+ECAT**
- EtherNet/IP **+EIP**
- LXI TCP/IP Ethernet **+LXI**
- ModbusTCP **+MTCP**
- PROFINET **+PROF**

AC Input Specifications	
Input Voltages Available Refer to models table for AC input voltage availability by power level AC Input voltage specified at time of order and cannot be modified	UI, 100-240 Vac, 1-phase UI2, 208-240 Vac, 1-phase 208 Vac, 3-phase 240 Vac, 3-phase 380/400 Vac, 3-phase 415 Vac, 3-phase 440 Vac, 3-phase 480 Vac 3-phase
Input Voltage Tolerance	± 10%
Input Voltage Frequency	50-400 Hz
Power Factor Measured at max power	> 0.99, 1-phase UI and UI2 AC inputs > 0.92, 3-phase AC inputs
Input Isolation Measured line-to-ground	± 2000 Vdc
DC Output Specifications	
Voltage Ripple	Model specific. Refer to models table.
Line Regulation	Voltage control: ± 0.06% of rated voltage Current control: ± 0.08% of rated current Power control: ± 0.08% of rated power
Load Regulation	Voltage control: ± 0.02% of rated voltage Current control: ± 0.06% of rated current Power control: ± 0.08% of rated power
Stability FWHM, measured at 25°C over 8 hrs after 30 min warm-up	Voltage control: ± 0.005% of rated voltage Current control: ± 0.075% of rated current
Temperature Coefficient	Voltage control: 0.01%/°C of rated voltage Current control: 0.04%/°C of rated current Power control: 0.04%/°C of rated power
Efficiency	Up to 95%. Model specific. Refer to Models table.
Slew Rate, Voltage Standard models, programmable	Minimum (Slowest): Rated voltage x 2 ⁻¹⁵ [V/ms] Maximum (Fastest): Rated voltage x 0.006 [V/ms]
Slew Rate, Current Standard models, programmable	Minimum (Slowest): Rated current x 2 ⁻¹⁵ [A/ms] Maximum (Fastest): Rated current x 0.005 [A/ms]
Slew Rate, Power Standard models, programmable	Minimum (Slowest): Rated power x 2 ⁻¹⁵ [W/ms] Maximum (Fastest): Rated power x 0.0025 [W/ms]
Output Isolation Models Rated ≤ 1500 Vdc Measured output-to-ground	± 2000 Vdc
Output Isolation Models Rated > 1500 Vdc Measured output-to-ground	± (2750 Vdc + Vo/2), where Vo is the maximum output voltage of the power supply
Interface Specifications	
Front Panel Programming	Machined aluminum rotary knob with encoder, key-pad, and up-down arrow for single bit control
Communication Interfaces Standard	USB Host (Front): Type B USB Host (Rear): Type B RS485 (Rear): RJ-45 MagnaLINK™: RJ-25 x 2
External User I/O Port Standard	26-pin D-sub DB-26, female Referenced to ground; isolated from the DC output See User Manual for pin layout
Communication Interfaces Optional	CANopen (+CAN): DB-9 EtherCAT (+ECAT): RJ-45 x 2 EtherNet/IP (+EIP): RJ-45 x 2 LXI TCP/IP Ethernet (+LXI): RJ-45 ModbusTCP (+MTCP): RJ-45 x 2 PROFINET (+PROF): RJ-45 x 2

Programming Specifications	
Resolution, Digital Programming Front panel or communication interfaces	16-bit, 0.00153% of rated voltage, current or power
Accuracy, Digital Programming Output value to set point value, programmed via front panel or communication interfaces	Voltage: ± 0.06% of rated voltage Current: ± 0.06% of rated current Power: ± 0.10% of rated power
Accuracy, Digital Measurement Output value to returned value, via front panel display or communication interfaces	Voltage: ± 0.08% of rated voltage Current: ± 0.08% of rated current Power: ± 0.10% of rated power
Accuracy, Analog Programming Output value to set point value, programmed via analog input	Voltage: ± 0.12% of rated voltage Current: ± 0.08% of rated current Power: ± 0.12% of rated power
Resolution, Analog Programming 0-10 V analog input	12-bit, 0.025% of rated voltage, current or power
Accuracy, Analog Programming, High Speed Input Output value to set point value, programmed via the high-speed analog input	Voltage: ± 0.80% of rated voltage Current: ± 0.80% of rated current Power: ± 1.20% of rated power
Accuracy, Analog Measurement Output value to returned value, via analog output	Voltage: ± 0.08% of rated voltage Current: ± 0.08% of rated current Power: ± 1.20% of rated power
Analog I/O 3 configurable standard analog inputs 1 configurable high-speed analog input 4 configurable standard analog outputs Reference signal provided	High-Speed Input Sampling Rate: 2 kHz Programming Voltage: 0-10 V Monitoring Voltage: 0-10 V, 3 mA capacity Monitoring Impedance: 0.005 Ω Reference Voltage: 10 V, 20 mA capacity
Digital I/O 5 configurable digital inputs 7 configurable digital outputs Reference signal provided	Voltage Level: 5 V Input Impedance: 10 kΩ Monitoring Voltage: 5 V, 32 mA capacity Reference Voltage: 5 V, 20 mA capacity
Physical Specifications	
Size All models	1U 1.75" H x 19" W x 24" D (4.4 x 48.3 x 61.0 cm)
Weight	1.5 kW models: 32 lbs (14.52 kg) 2.6 kW models: 34 lbs (15.42 kg) 4 kW models: 35 lbs (15.88 kg) 6 kW models: 35 lbs (15.88 kg) 8 kW models: 36 lbs (16.33 kg) 10 kW models: 36 lbs (16.33 kg)
Racking Standard	EIA-310
Rear Support Rails	Included
Environmental Specifications	
Ambient Operating Temperature	0°C to 50°C
Storage Temperature	-40°C to +85°C
Humidity	Relative humidity up to 95% non-condensing
Air Flow	Side air inlet, rear exhaust
Regulatory Specifications	
EMC	Complies with 2014/30/EU (EMC Directive) CISPR 22 / EN 55022 Class A
Safety	Complies with EN61010-1 and 2014/35/EU (Low Voltage Directive)
CE Mark	Yes
RoHS Compliant	Yes
REACH Compliant	Yes

Dimensional Diagrams

Standard Models

Models rated up to 1500 Vdc, air cooled

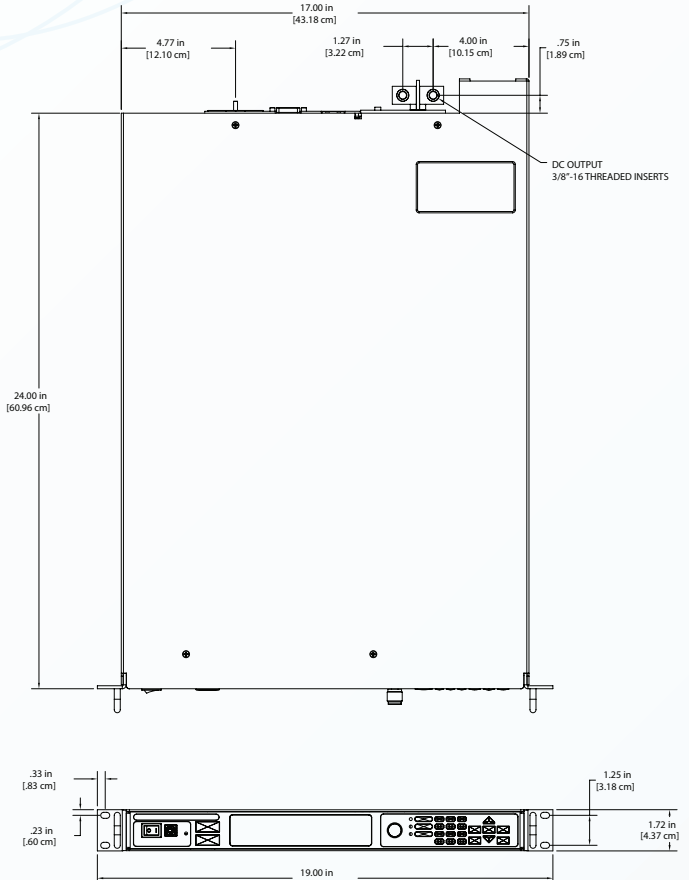
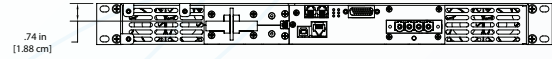
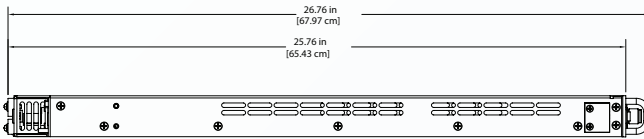
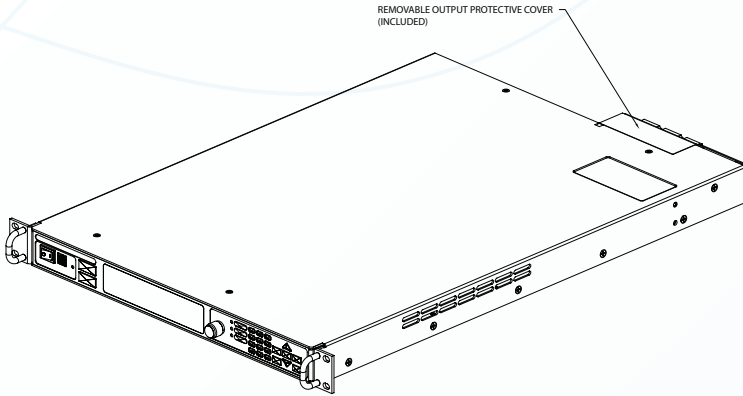

Communications Interface

Standard rear interfaces shown.
Front panel full control USB interface included (not shown).
Diagrams for optional interfaces detailed in the options section.

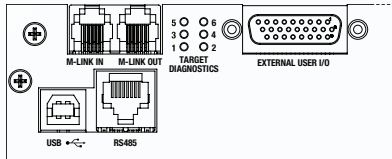

DC Output (Angled)

Qty (2) tin-plated copper bus bars with 3/8"-16 threaded inserts. Mating hardware included (not shown).
3/8" 6-32 remote voltage sense terminals.
Molex 436500227 current sense connector.

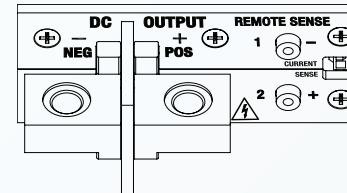

AC Input • 1-phase, 8 AWG

For SLx Series models with 1-phase UI or UI2 input.
Phoenix Contact 1720916, 2-wire + ground connector.
Phoenix Contact 1777846 mating adapter included.

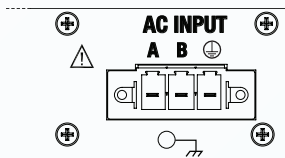

AC Input • 3-phase, 8 AWG

For SLx Series models with 3-phase input, except 10 kW models with 208/240 Vac input.
Phoenix Contact 1720929, 3-wire + ground connector.
Phoenix Contact 1777859 mating adapter included.

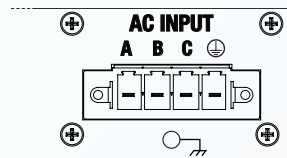

AC Input • 3-phase, 6 AWG

For 10 kW SLx Series models with 208/240 Vac 3-phase input.
Phoenix Contact 1998881, 3-wire + ground connector.
Phoenix Contact 1967472 mating adapter included.

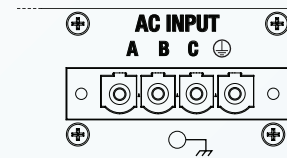

3D STP file available to download from [SLx Series Downloads](#) on [magna-power.com](#)

Dimensional Diagrams

Models with Water Cooling (+WC) Option

Models rated up to 1500 Vdc, water cooled

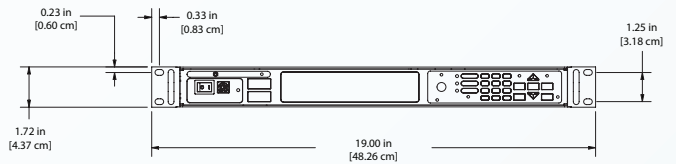
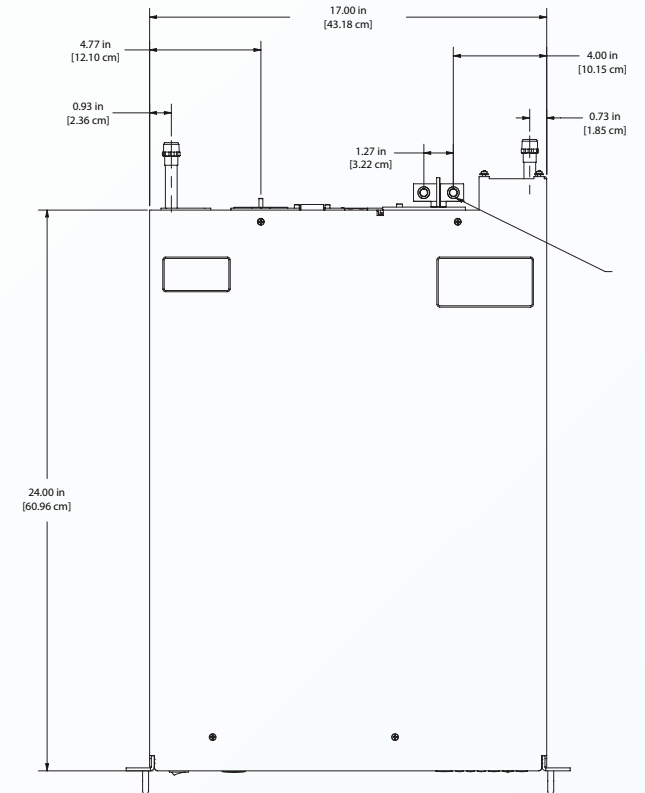
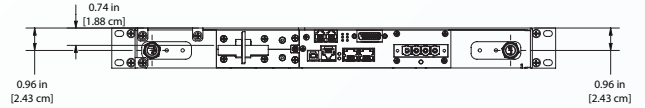
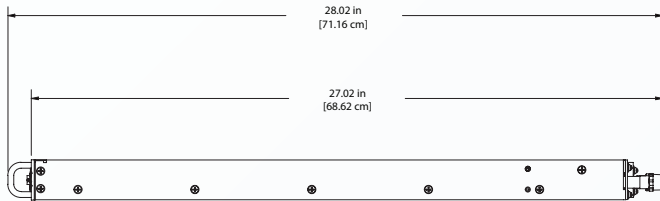
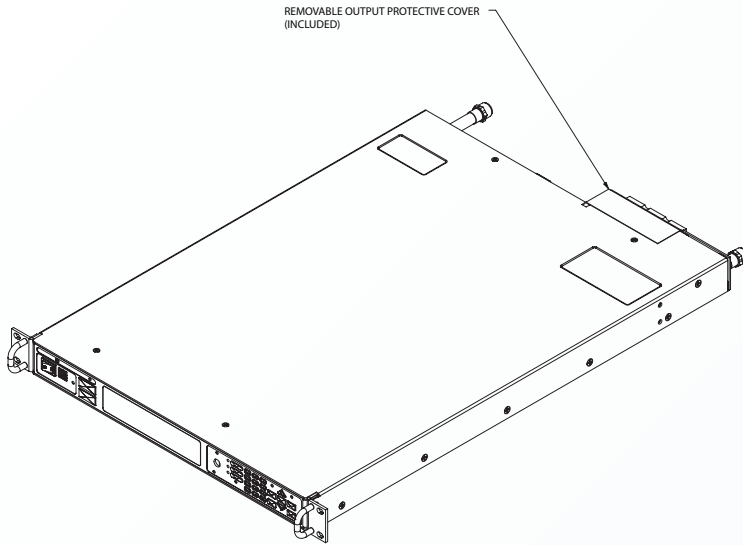

Rear Rack Support Rails

Included with all SLx Series models

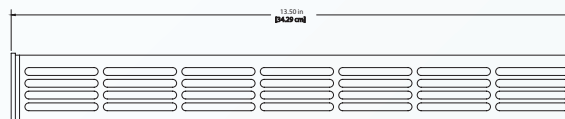
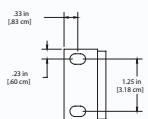
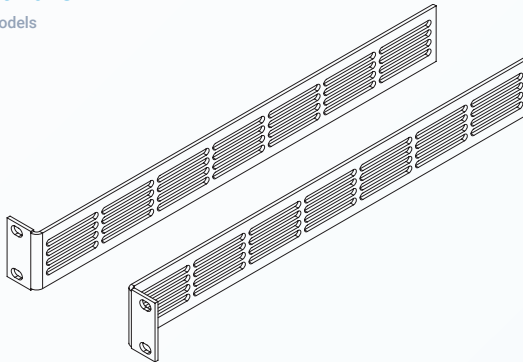

3D STP file available to download from [SLx Series Downloads](#) on [magna-power.com](#)

MAGNACTRL Software

Magna-Power's brand new MagnaCTRL Software comes standard with all SLx Series products, providing a modern, feature-rich, multi-product control platform. MagnaCTRL provides various Panels to allow for computer-based control, monitoring, calibration, and firmware update capabilities.

Product Supported
ALx Series, SLx Series

Operating Systems Supported
Microsoft Windows 10/11 (32- and 64-bit)

Communication Interfaces Supported
USB, RS485 or LXI TCP/IP Ethernet (+LXI)

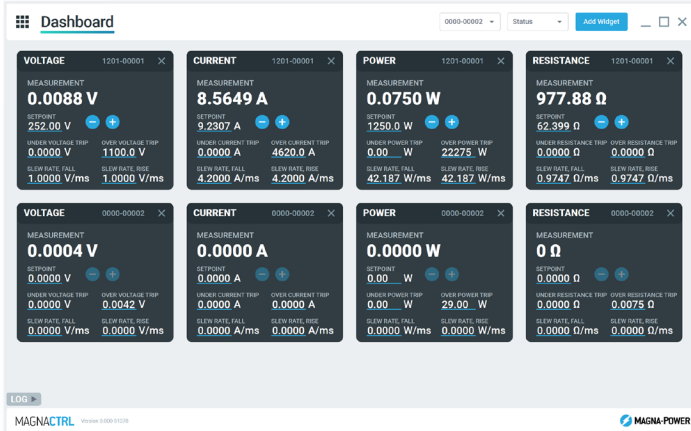

Dashboard Panel Add and remove widgets from multiple connected Magna-Power products, simultaneously, to build a dashboard using parameters and controls that are important for the specific user. Easily drag and drop widgets to organize the Dashboard.

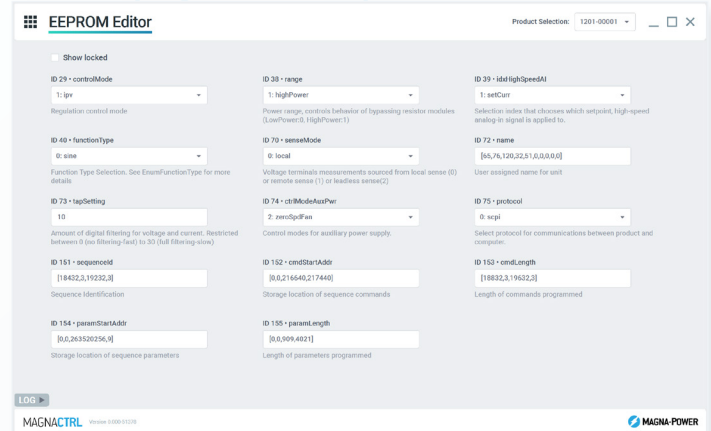

EEPROM Editor Panel Allow Magna-Power applications and support technicians to look behind-the-scenes at the product's configuration parameters using the EEPROM Editor.

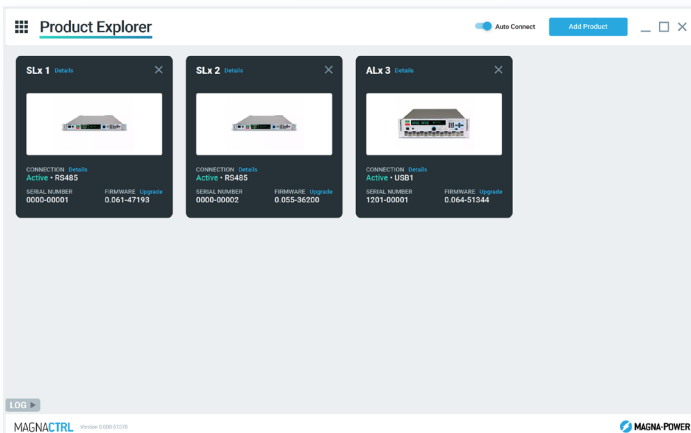

Product Explorer Panel Easily detect connected products and add them to the Product Explorer to make them accessible in the various MagnaCTRL panels. MagnaCTRL retains the product connection details for future sessions, with the ability Auto Connect when the products are detected.

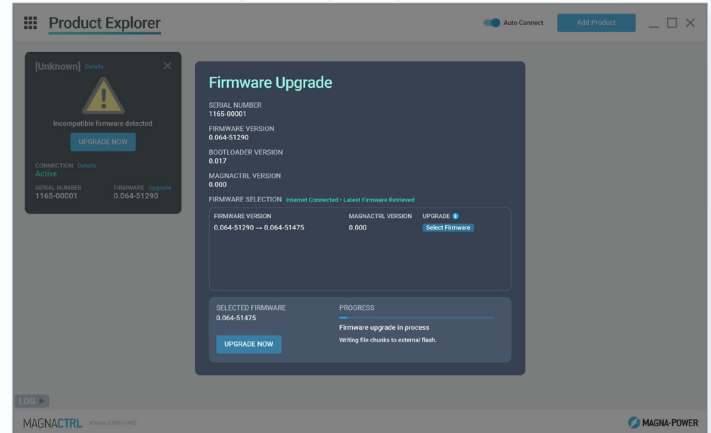

Firmware Update Detect when new versions of firmware or MagnaCTRL software is available and automatically update. Manual firmware updates can also be performed without internet connection.

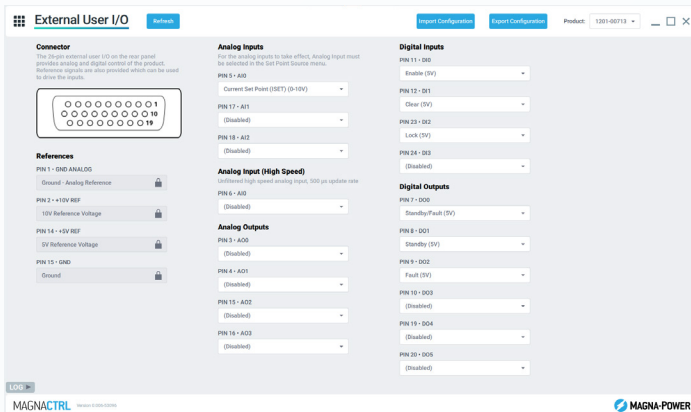

External User I/O Configuration Configure the product's 26-pin external user I/O connector with custom pin mappings, selecting the appropriate parameters for the application. Easily export the pin mappings so they can be imported on other xGen products.

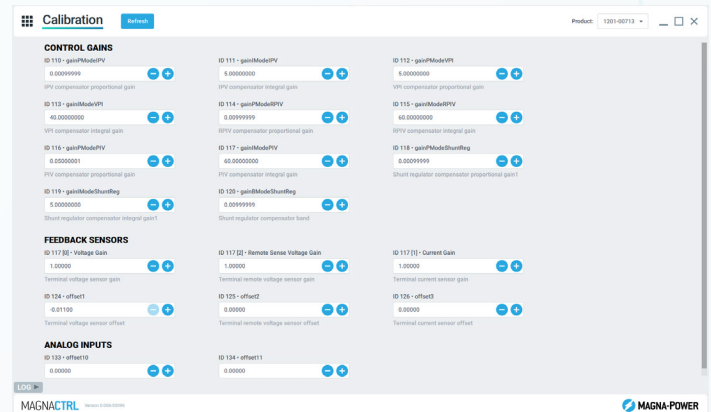

Calibration Calibrate the product's various parameters through programming/measurement gain and offset values. In addition, under the guidance of Magna-Power, access control loop gain parameters to change the product's response.

Available Options

CANopen (+CAN)

CANopen is a high-level communication protocol that is widely used in industrial automation and embedded systems. It is based on the Controller Area Network (CAN) bus, a robust and efficient serial communication bus commonly found in automotive and industrial applications.

CANopen defines a set of communication protocols and application layer services built on top of the CAN physical layer. It provides a standardized way for devices to communicate and exchange data. CANopen devices communicate using an Object Dictionary, which defines the data structure and parameters that can be exchanged between devices. This dictionary is essential for device configuration and data exchange. It includes objects like PDOs (Process Data Objects) for real-time data exchange and SDOs (Service Data Objects) for parameterization and configuration. Each CANopen device on the network has a unique Node ID, which allows devices to address each other for communication. This addressing scheme simplifies the setup of multi-device networks.

This option provides support for the product's full command set over CAN with extensive documentation detailing both connection setup and commands. A D-Sub 9-pin male connector is provided along with a Magna-Power developed CANopen Electronic Data Sheet (EDS), used by network configuration software tools to help set up devices on the network.

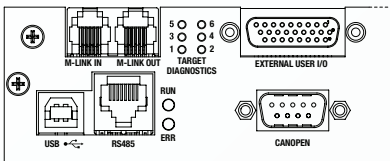

Rear communication interfaces with CANopen (+CAN) option.

EtherCAT (+ECAT)

EtherCAT is a real-time Ethernet network protocol developed by Beckhoff Automation for communicating among multiple nodes. EtherCAT networks are formed using CAT cabling, where master and nodes can be directly wired together through RJ-45 ports, in a daisy chain configuration, without need for external networking switches. The protocol is standardized in IEC 61158 and is popular for demanding high-speed communication requirements in automation technology. As a result of its flexibility and scalability, EtherCAT can be found in a wide range of applications, including factory automation, motion control, robotics, and more.

This option provides support for the EtherCAT protocol and Ethernet over EtherCAT. The product's full command set is supported with extensive documentation detailing both connection setup and commands. Dual RJ-45 connectors are provided with bi-color activity and error LEDs.

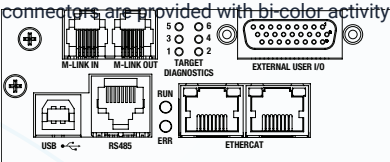

Rear communication interfaces with EtherCAT (+ECAT) option.

EtherNet/IP (+EIP)

The EtherNet/IP standard (EIP) is the application layer protocol for industrial automation developed by four independent groups: ODVA, the Industrial Open Ethernet Association (IOANA), Control Net International (CI) and the Industrial Ethernet Association (IEA). EtherNet/IP provides wide-ranging, comprehensive, certifiable standard in the public domain that is suitable to a wide variety of automation devices. EtherNet/IP uses a client-server model, where the client sends requests to the server, and the server responds with the requested information. The information is transmitted in the form of messages, which are divided into two types: Explicit and Implicit messages.

Magna-Power has designed its EtherNet/IP (+EIP) option to allow for seamless integration into Allen Bradley, Schneider Electric and Omron PLCs. The following are some of the key features for Magna-Power's +EIP option:

- Support for the product's full command set
- Extensive HTML- and PDF-based documentation, detailing connection setup and commands
- Dual RJ-45 connectors with bi-color activity and error LEDs
- Magna-Power developed electronic data sheet (EDS) for device discovery and network setup
- Hosted a EtherNet/IP web page for easily accessing local network settings, device parameters, and operation status

MAGNA-POWER

Current IP Settings

Overview	On/Off	Enabled
Parameters	IP Address:	192.168.0.103
	Subnet Mask:	255.255.252.0
NETWORK	Gateway Address:	192.168.1.50
Status	Host Name:	
Configuration	Domain Name:	magna-power.local
SERVICES	DNS Server #1:	192.168.1.238
SMTP	DNS Server #2:	192.168.202.238

Current Ethernet Status

MAC Address:	0030113A-EEFD
Port 1:	100 FDX
Port 2:	No Link

Interface Counters

	Port 1	Port 2	Internal	[Refresh]
In Octets:	1102943	0	542179	
In Unicast Packets:	191	0	189	
In Multicast Packets:	6007	0	5390	
In Discards:	0	0	0	
In Errors:	0	0	0	
In Unknown Protos:	0	0	194	
Out Octets:	207375	0	290256	
Out Unicast Packets:	217	0	220	
Out Multicast Packets:	14	0	14	
Out Discards:	0	0	0	
Out Errors:	0	0	0	

Media Counters

EtherNet/IP webpage hosted in Magna-Power's +EIP option with EtherNet/IP (+EIP) option.

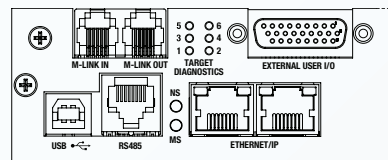

Rear communication interfaces with EtherNet/IP (+EIP) option.

Available Options Continued

LXI TCP/IP Ethernet (+LXI)

Certified to the LXI Standard (Class C), the +LXI option allows the product to be fully controlled over an a traditional computer network with a fully integrated TCP/IP Ethernet interface.

LXI is an instrumentation platform based on industry standard Ethernet technology designed to provide modularity, flexibility, and performance to small- and medium-sized systems. All of the product's standard SCPI commands are supported over the +LXI option, along with all provided software and drivers. The LXI TCP/IP Ethernet interface also support mDNS, a protocol that allows devices to perform DNS operation on a local link, even without the presence of an administered DNS server.

LXI's advantages are exemplified in its compact, flexible package providing high-speed I/O and reliable measurements. The Magna-Power Electronics LXI TCP/IP Ethernet option includes an embedded web-server, allowing configuration of static or dynamic IP address assignment.

Note: Only the SCPI command protocol is available when LXI TCP/IP Ethernet interface is installed. Modbus communication protocol is not available through any interface when the LXI TCP/IP Ethernet interface is installed.

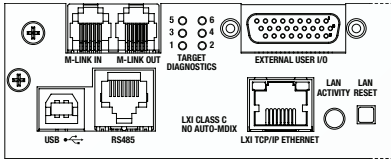

Rear communication interfaces with LXI TCP/IP Ethernet (+LXI) option.

Modbus-TCP (+MTCP)

Modbus-TCP is a communication protocol that enables communication between industrial devices over Ethernet networks. It is an extension of the Modbus protocol, which was originally developed in the 1970s for communication between programmable logic controllers (PLCs) and other devices. Modbus-TCP uses the same protocol as Modbus, but it is transmitted over Ethernet rather than serial communication.

Modbus-TCP is a widely used protocol in industrial control and automation applications because it is open and simple to implement. It supports a wide range of devices, including PLCs, sensors, and actuators. Modbus-TCP provides fast and reliable communication, with data rates of up to 100 Mbps. It also supports multiple connections and can handle up to 65,535 devices on a single network.

This option provides support for the product's full Modbus command set over ModbusTCP with extensive documentation detailing both connection setup and commands. Dual RJ-45 connectors are provided with bi-color activity and error LEDs.

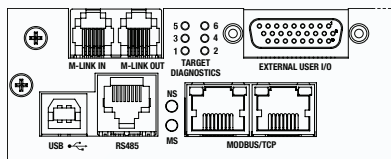

Rear communication interfaces with Modbus-TCP (+MTCP) option.

PROFINET (+PROF)

PROFINET is a widely-used industrial Ethernet protocol for communication between automation systems and devices in manufacturing and process industries. It was developed by PROFIBUS & PROFINET International (PI), an organization that oversees the development and maintenance of the protocol. PROFINET is used mainly by Siemens PLCs.

PROFINET is widely adopted by many leading manufacturers and system integrators in different industries due to its reliability, flexibility, and interoperability. It has a large ecosystem of compatible products and tools, and is supported by a global network of PI-certified experts and service providers.

This option provides support for the product's full command set over PROFINET with extensive documentation detailing both connection setup and commands. Dual RJ-45 connectors are provided with bi-color activity and error LEDs.

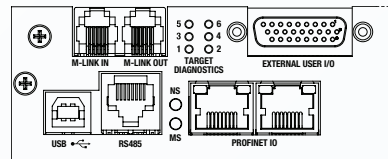

Rear communication interfaces with PROFINET (+PROF) option.

Ruggedized (+RUG)

The Ruggedized Option (+RUG) provides additional mechanical security for large power components and sub-assemblies within SLx Series products. Board mounted through components, such as capacitors, inductors, and daughter boards are staked using an UV-cured epoxy in accordance with the recommendations from relevant IPC-A-610G standards.

SLx Series units with the Ruggedized Option have been independently tested to comply with the following MIL-STD-810G shock and vibration specifications:

- MIL-STD-810G CHG1 Method 516.7 Functional Shock, Procedure I; which subjects the product to 40G, 11 ms terminal saw tooth pulse; three shocks in each direction along three mutually perpendicular axes
- MIL-STD-810G CHG1 Method 514.7 Vibration; which subjects the product to two hours of vibration per axis along three mutually perpendicular axes

In addition to the specifications listed above, the SLx Series units with the Ruggedized Option have also been independently tested to comply with RTCA/DO-160G Section 8.0 Vibration, Profile B4 with its associated total energy of 2.2 Grms for equipment installed in Fixed Wing aircrafts with Turbojet or Turbofan engines.

All products with the Ruggedized Option maintain ambient operating temperatures from -25°C to 50°C and storage temperatures from -35°C to +85°C.

Water Cooling (+WC)

Water cooling is available for the SLx Series for use in densely packaged system cabinets where heat removal by standard air cooling is a challenge. The option utilizes internal chill plates and a central heat exchanger to remove heat from sensitive components and internal air. The 1U enclosure is sealed from the environment (no vent holes), making it suitable for harsh or controlled environments.

To prevent internal condensation, an integrated solenoid valve enables water flow only when internal temperatures reach 60°C.

- Inlet/Outlet Connection: 1/4" NPT male pipe
- Minimum Flow Rate: 1.2 GPM
- Maximum Pressure: 80 PSI
- Maximum Inlet Temperature: 25°C