SLx Series Documentation

Release 1

Magna-Power Electronics, Inc.

Oct 24, 2024

CONTENTS

1	Preface	1
1.1	Contact Magna-Power	1
1.2	Safety Notice	1
1.3	Safety Symbols	3
1.4	Limited Warranty	3
1.5	User Manual Warranty	4
1.6	U.S. Government Rights	4
1.7	WEEE Directive 2002/96/EC	5
1.8	Declaration of Conformity	5
1.9	Document Conventions	5
1.10	Additional Help and Feedback	6
2	Product Information	7
2.1	Key Features	7
2.2	Models	9
2.3	Specifications	14
3	Installation	19
3.1	Inspection	19
3.2	Rack Installation	20
3.3	AC Input Connection	23
3.4	DC Output Connection	27
3.5	Remote Sense Connection	28
3.6	External User I/O Connection	29
3.7	Computer Connection	29
3.8	Electrical Check	31
4	Features and Functions	33
4.1	Set-Points	33
4.2	Commands	33
4.3	Function Generator	34
4.4	Control Modes	36
4.5	Regulation States	37
4.6	Protection and Diagnostics	39
4.7	Statuses	45
4.8	Status Messages	45
4.9	Factory Restore	46
5	MagnaLINK	53
5.1	Network Overview	53

5.2	Master-Slave Module Operation	53
6	Operation: Front Panel	55
6.1	Operation: Front Panel	55
6.2	Menu System Listing	58
7	Operation: External User I/O	63
7.1	Analog Inputs	64
7.2	Analog Outputs	65
7.3	Digital Inputs	66
7.4	Digital Outputs	67
8	Operation: Computer Programming	69
8.1	Operation: Computer Programming	69
8.2	Programming Methods	73
8.3	USB Communications	73
8.4	RS485 Communications	73
8.5	LXI TCP/IP Ethernet Communications	73
8.6	MagnaCTRL	78
9	SCPI Command Set	79
9.1	SCPI Command Set	79
9.2	SCPI Command Set	82
10	Modbus Command Set	101
10.1	Modbus RTU over Serial	101
10.2	Modbus Terminology	102
10.3	Device Addressing Mode	102
10.4	Functions	102
10.5	Data Format	103
10.6	Error Handling	103
10.7	Communication Examples	104
10.8	Register List	107
11	EtherNet/IP Command Set	121
11.1	EtherNet/IP Overview	121
11.2	Physical Interface	124
11.3	Diagnostic and Simulation Tools	126
11.4	Communication Examples	130
11.5	Development Using Studio 5000	134
11.6	Instances Listing	139
12	EtherCAT Command Set	153
12.1	EtherCAT Overview	153
12.2	Physical Interface	153
12.3	Data Objects	154
12.4	EtherCAT State Machine	155
12.5	Development using TwinCAT	156
12.6	Standard Object Dictionary	163
12.7	Manufacturer Specific Instances Listing	163
12.8	Manufacturer Specific Process Data Objects	164
12.9	Manufacturer Specific Service Data Objects	167
13	PROFINET Command Set	177
13.1	PROFINET Overview	177

13.2	Physical Interface	178
13.3	Communication Examples	179
13.4	Instances Listing	179
14	CANopen Command Set	181
14.1	CANopen Overview	181
14.2	Physical Interface	181
14.3	Data Objects	182
14.4	CANopen State Machine	183
14.5	CANopen Default Node Settings	183
14.6	Development using Python	184
14.7	Standard Object Dictionary	187
14.8	Manufacturer Specific Instances Listing	187
14.9	Manufacturer Specific Process Data Objects	188
14.10	Manufacturer Specific Service Data Objects	191

PREFACE

Thank you for choosing a Magna-Power Electronics product. This document provides user, service, and programming information the SLx Series MagnaDC power supply. If you have any suggestions or feedback for this document, please contact Magna-Power at feedback@magna-power.com.

1.1 Contact Magna-Power

Magna-Power support can be contacted for service, technical support, or spare parts:

- By Phone: +1-908-237-2200
- By Email: support@magna-power.com

Visit magna-power.com/support for more support resources and information about contacting Magna-Power worldwide.

1.2 Safety Notice

The following general safety precautions must be observed during all phases of operation of this instrument. Failure to comply with these precautions or with specific warnings elsewhere in this manual violates safety standards of design, manufacture, and intended use of the instrument. Neither Magna-Power Electronics nor any of the associated sales organizations accept responsibility for personal injury, consequential injury, loss, or damage resulting from improper use of the equipment and accessories.

Installation and service must be performed only by properly trained and qualified personnel who are aware of dealing with electrical hazards. Ensure that the AC power line ground is properly connected to the MagnaDC power supply chassis. Furthermore, other power grounds, including those connected to application maintenance equipment, must be grounded for both personnel and equipment safety.

This product is a Safety Class 1 instrument, provided with a protective earth terminal. The protective features of this product may be impaired if it is used in a manner not specified in the operation instructions.

<p>Warning: Residual voltage. Lethal voltages may be present inside the MagnaDC power supply even when the AC input voltage is disconnected. Only properly trained and qualified personnel should remove covers and access the inside of the MagnaDC power supply.</p>

During normal operation, the operator does not have access to hazardous voltages within the product's chassis. Depending on the application, high voltages hazardous to human safety may be present on the DC power terminals. Ensure that the DC power cables are properly labeled as to the safety hazards and that any inadvertent contact with hazardous voltages is eliminated.

Do not install substitute parts or perform unauthorized maintenance on the product.

These operating instructions form an integral part of the equipment and must be available to the operating personnel at all times. All the safety instructions and advice notes are to be followed.

Warning: General. Do not use this product in any manner not specified by the manufacturer. The protective features of this product may be impaired if it is used in a manner not specified in the operating instructions.

Warning: Environmental Conditions. Never use the instrument outside of the specified environmental conditions described in the Environmental Characteristics of the specifications.

Warning: Ground the Instrument. This product is provided with protective earth terminals. To minimize shock hazard, the instrument must be connected to the AC mains through a grounded power cable, with the ground wire firmly connected to an electrical ground (safety ground) at the power outlet. Any interruption of the protective (grounding) conductor or disconnection of the protective earth terminal will cause a potential shock hazard that could result in injury or death.

Warning: Before Applying Power. Verify that all safety precautions are taken. All connections must be made with the unit turned off, and must be performed by qualified personnel who are aware of the hazards involved. Improper actions can cause fatal injury as well as equipment damage. Note the instrument's external markings described under "Safety Symbols".

Warning: Do Not Operate in an Explosive Atmosphere. Do not operate the instrument in the presence of flammable gases or fumes.

Warning: Do Not Remove the Instrument Cover. Only qualified, service-trained personnel who are aware of the hazards involved should remove instrument covers. Disconnect the power cable and any external circuits before removing instrument covers.

Warning: Do Not Modify the Instrument. Do not install substitute parts or perform any unauthorized modification to the product, except with the direction of Magna-Power support personnel. Return the product to a Magna-Power authorized service center for repair.

Warning: In Case of Damage. Instruments that are not functioning correctly, appear damaged or defective should be made inoperative and secured against unintended operation until they can be repaired by qualified service personnel.

1.3 Safety Symbols

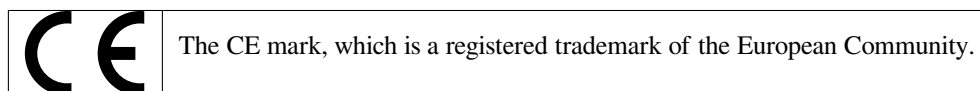
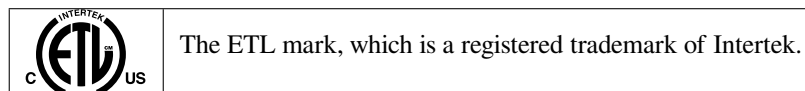
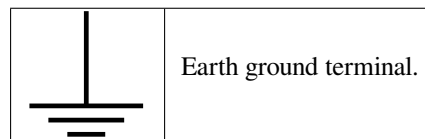
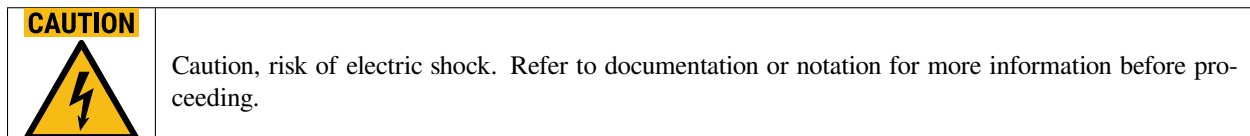
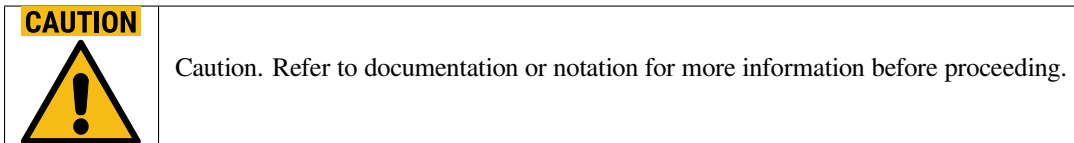

1.4 Limited Warranty

The following is made in lieu of all warranties expressed or implied.

Magna-Power Electronics, Inc. warrants its products to be free of manufacturing defects for a period of two years from date of original shipment from its factory. Magna-Power Electronics, Inc. will repair, replace, or refund the purchase price at its discretion, which upon examination by Magna-Power Electronics, Inc., is determined to be defective in material or workmanship, providing such claimed defective material is returned upon written authorization of Magna-Power Electronics, Inc., freight and duties prepaid.

For products failing within the first 30 days of the warranty period, Magna-Power Electronics, Inc. will return the repaired product at its expense using a standard ground shipping method; after 30 days of the warranty period, the repaired product will be returned at the customer's expense using the customer's requested shipping method.

Damage due to corrosion, customer alterations, excessive dust, extreme environmental or electrical conditions, and/or misuse will be evaluated upon inspection. If inspection reveals that the cause of damage is not due to materials or workmanship, repair of the product will be treated on a non-warranty basis.

All electrical, commercial supply parts, and items not manufactured by Magna-Power Electronics, Inc. shall carry the warranty of the original manufacturer and no more, but under no circumstances to exceed the warranty period. Replacement parts shall be warranted for a period of 90 days. Warranty labor shall only apply if the product, assembly, or part is returned to the factory freight prepaid and insured. Damage or breakage while in transit is not covered by this warranty.

Magna-Power Electronics, Inc. assumes no responsibility to Buyer for labor to diagnose and remove defective product and installation of replacement product. Furthermore, Magna-Power Electronics, Inc. is not liable to Buyer or to any third party for consequential or incidental damages under any circumstances, whether due to defect in the product, due to delay or failure of delivery, due to a failure of the product to perform as specified, or for any other reason or cause. Buyer and Magna-Power Electronics, Inc. agree that Buyer's sole remedy and Magna-Power Electronics, Inc.'s sole liability to Buyer is limited to repair, replacement, or refund of the purchase price of the product as described herein, whether Buyer's claim arises out of contract or in tort.

All claims against the warranty shall be the final determination of Magna-Power Electronics, Inc.

1.5 User Manual Warranty

The material contained in this document is provided "as is," and is subject to being changed, without notice, in future editions. Further, to the maximum extent permitted by applicable law, Magna-Power disclaims all warranties, either express or implied, with regard to this manual and any information contained herein, including but not limited to the implied warranties of merchantability and fitness for a particular purpose. Magna-Power shall not be liable for errors or for incidental or consequential damages in connection with the furnishing, use, or performance of this document or of any information contained herein. Should Magna-Power and the user have a separate written agreement with warranty terms covering the material in this document that conflict with these terms, the warranty terms in the separate agreement shall control.

1.6 U.S. Government Rights

The Software is "commercial computer software," as defined by Federal Acquisition Regulation ("FAR") 2.101. Pursuant to FAR 12.212 and 27.405-3 and Department of Defense FAR Supplement ("DFARS") 227.7202, the U.S. government acquires commercial computer software under the same terms by which the software is customarily provided to the public. Accordingly, Magna-Power provides the Software to U.S. government customers under its standard commercial license, which is embodied in its End User License Agreement (EULA). The license set forth in the EULA represents the exclusive authority by which the U.S. government may use, modify, distribute, or disclose the Software. The EULA and the license set forth therein, does not require or permit, among other things, that Magna-Power: (1) Furnish technical information related to commercial computer software or commercial computer software documentation that is not customarily provided to the public; or (2) Relinquish to, or otherwise provide, the government rights in excess of these rights customarily provided to the public to use, modify, reproduce, release, perform, display, or disclose commercial computer software or commercial computer software documentation. No additional government requirements beyond those set forth in the EULA shall apply, except to the extent that those terms, rights, or licenses are explicitly required from all providers of commercial computer software pursuant to the FAR and the DFARS and are set forth specifically in writing elsewhere in the EULA. Magna-Power shall be under no obligation to update, revise or otherwise modify the Software. With respect to any technical data as defined by FAR 2.101, pursuant to FAR 12.211 and 27.404.2 and DFARS 227.7102, the U.S.

government acquires no greater than Limited Rights as defined in FAR 27.401 or DFAR 227.7103-5 (c), as applicable in any technical data

1.7 WEEE Directive 2002/96/EC

This product complies with the Waste Electrical and Electronic Equipment (WEEE) Directive 2002/96/EC marking requirement. The affixed product label (see below) indicates that you must not discard this electrical/electronic product in domestic household waste.



Product Category: With reference to the equipment types in the WEEE directive Annex 1, this product is classified as “Monitoring and Control instrumentation” product.

Do not dispose products in domestic household waste.

To return unwanted products, [contact Magna-Power Electronics](#).

1.8 Declaration of Conformity

Magna-Power Electronics declares on its sole responsibility that the SLx Series MagnaDC power supply complies with the essential requirement of the relevant European Directives, and is eligible to carry the CE mark.

1.9 Document Conventions

This user’s manual uses several conventions to highlight certain words and phrases and draw attention to specific pieces of information.

Note: Notes are tips, shortcuts or alternative approaches to the task at hand. Ignoring a note should have no negative consequences, but you might miss out on a time saving procedure.

Warning: The warning sign denotes a hazard, calling attention to a procedure or practice. If a warning is not correctly performed or adhered to, it could result in personal injury. Do not proceed beyond a warning sign until the conditions are fully understood or met.

Caution: The caution sign denotes a hazard, calling attention to a procedure or practice. If a caution is not correctly performed or adhered to, it could result in damage to the product. Do not proceed beyond a caution sign until the conditions are fully understood or met.

Source-code listings are also set in mono-spaced roman but add syntax highlighting as follows:

```
#!/usr/bin/python
# -*- coding: utf-8 -*-

from serial import Serial

class Magna(Serial):
def __init__(self, port, expected_serial_number=None, log=None):
    super(Magna, self).__init__(port, baudrate=19200, timeout=2.0)
    self.log = log if log else self.magna_log
    self.write('*CLS\r\n')
```

1.10 Additional Help and Feedback

For additional help or to provide feedback about the product's design and features, please contact: support@magna-power.com.

PRODUCT INFORMATION

2.1 Key Features

Building on over 40 years of power supply innovation and with over 26,500+ different model configurations, the SLx Series MagnaDC power supply is Magna-Power's most versatile programmable DC power supply series ever created. The SLx Series offers models at 6 different power levels, with highly granular range of voltages and currents. With industry-leading power density, rugged current-fed power processing, and the state-of-the-art MagnaLINK™ distributed DSP digital control architecture, the SLx Series meets the long-term DC power requirements of research & development, industrial automation, and process control applications. The key features of the SLx Series is as follows:

Product Features

- Voltage, current, and power control
- Rugged current-fed power processing
- 16-bit precision with single bit control
- SCPI and Modbus command sets
- Programmable protection features
- Interlock and hardware emergency stop
- Interlock and hardware emergency stop
- Slew rate control
- Continuous full power operation up to 50°C ambient
- Configurable analog-digital 26-pin I/O port
- Digital-hybrid MagnaLINK™ master-slaving
- Local, remote, and leadless voltage sensing
- USB (front and rear) and RS485 interfaces standard
- CAN, EtherCAT, EtherNet/IP, LXI TCP/IP Ethernet, ModbusTCP, and PROFINET fully integrated communications options available
- MagnaCTRL software platform included
- Made in the USA

2.1.1 Key Features Overview

- **MagnaLINK™ Distributed Digital Control** Magna-Power developed its MagnaLINK™ digital control platform from the ground up to utilize an array of four Texas Instruments DSPs distributed across various internal assemblies. High-speed board-to-board communications is achieved between DSPs utilizing an internally developed low-level communication protocol. A custom bootloader ensures long-term support with multi-target firmware updates and synchronization. New capabilities are achieved with the MagnaLINK digital architecture, some of which include: slew rate control, gain modification, 16-bit precision, 100 ppm stability, user-defined sequencing and function generation, and digital hybrid master-slaving.
- **Reliable Current-Fed Power Processing** All MagnaDC programmable DC power supplies utilize high-frequency IGBT- and MOSFET-based power processing in current-fed topology. This topology adds an additional stage over the conventional voltage-fed topology for enhanced control and system protection, ensuring that even under a fault condition, the power supply will self-protect. Due to the self-protecting characteristics of this topology, the possibility of fast rising current spikes and magnetic core saturation is eliminated. This topology coupled with state-of-the-art Silicon Carbide (SiC) power semiconductors enables the SLx Series to deliver class-leading power density, reliability and efficiency with continuous full-power operation up to 50°C ambient. [Read Current-Fed Topology White Paper.](#)
- **Intuitive, Bright, Long-Lasting Front Panel Interface** Prioritizing brightness and reliability, the SLx Series features a hybrid display with bright green segments for voltage and current output and a multi-line display for power measurement, settings configuration, and status messages. A black-anodized machined aluminum control knob enables precise dialing of control set points, while a 10-digit key and arrow buttons provide digital set point inputs with 16-bit precision. In addition, a dedicated Lock button enables users to lock out the front panel to prevent unwanted changes from the front panel. Easily connect a computer to the SLx Series without going behind it by using the front panel USB port; a rear-mounted USB port is also provided.
- **Communication Interfaces for Industrial Control** SLx Series MagnaDC power supply come standard with Dual USB (front and back) and RS485. Options are available to provide seamless fully integrated communication for either traditional TCP/IP network control (SCPI or Modbus) or through direct control over industrial communication interfaces (Modbus). Magna-Power has taken significant measures to ensure comprehensive command-set support and documentation across the following optional interfaces: CANopen (+CAN), EtherCAT (+ECAT), EtherNet/IP (+EIP), LXI TCP/IP Ethernet (+LXI), Modbus-TCP (+MTCP), and PROFINET (+PROF).
- **Standard Safety Features with Emergency Stop** The SLx Series features a soft-start circuit to eliminate large peak in-rush currents from the AC mains, ensuring AC current draw never exceeds the current draw at full load. The SLx Series programmable DC power supplies have extensive safety and diagnostic functions, including: AC Phase Loss, Over Voltage Trip (Programmable), Over Current Trip (Programmable), Over Power Trip (Programmable), Cleared Fuse, Over Voltage on Program Line Input, Over Temperature on Internal Heatsink or Output Capacitors, Internal Communications Fault, Interlock and Emergency Stop Fault. When a fault is detected, the power supply immediately shuts down power processing circuit, utilizing the immediate one-shot trip (OSHT) zone event for inverter PWM channels. Users can easily identify faults using the Status message display or by SCPI/Modbus commands. Finally, both interlock and emergency stop features are included as standard. The interlock feature provides a 5V interlock input, which when coupled with the provided 5V reference signal, allows for a dry contact to easily trigger a latching interlock fault, while maintaining control power. A separate emergency stop feature bypasses all logic and processors to provide a hardware-only path to easily interrupt AC power to the SLx Series power supply with a 24V signal, providing a full hardware shutdown.
- **Plug & Play Master-Slaving** The SLx Series includes Magna-Power's next-generation digital hybrid master-slaving interface via dual digital MagnaLINK communication ports. With support up to 12 units in a master-slave set, users can easily expand their current capability by adding more units in parallel. A secondary current sense connection is provided, which provides real-time analog current feedback to the master, enabling reliable, high-accuracy measurement aggregation to a single display.
- **Target Diagnostics for Easy Field Servicing** The SLx Series introduces Magna-Power's Target Diagnostics feature, mapping the status LEDs for every major assembly to a rear mounted LED matrix. This LED matrix provides the statuses of each internal assembly, easily allowing users or support teams to understand faults or configuration

issues, while keeping products mounted and covers on. The Target Diagnostics feature coupled with MagnaCTRL's EPROM editor offers a robust suite of remote support tools to effectively reduce downtime.

- **Software Integration with Ease** With standard support for Standard Commands for Programmable Instrumentation (SCPI) and Modbus, SLx Series power supplies provide an easy-to-use API with well-documented commands in readable text. Over 60 commands allow programmatic access to product registers, starting and stopping the product, control of voltage, current and power, slew rate control, high-accuracy measurement queries, and product configuration. Simple scripting or complex software can be achieved, with extensive documentation and examples provided by Magna-Power.
- **Configurable User I/O for Analog & Digital Controls** All SLx Series power supplies come standard with a 26-pin D-Sub connector designated as the External User I/O. This connector provides: 8 Digital Outputs (5V logic), 4 Digital Inputs (5V logic), 4 Analog Outputs (0-10V logic), 4 Analog Inputs (0-10V logic). The External User I/O is isolated from the output terminals and referenced to earth ground. The connector's pins are user configurable, allowing users to select the functions needed in their application, while providing future capability for new features. Use the digital outputs to integrate the power supply with, for example, external enable signals or digital fault monitoring logic, or monitor voltage-current using the analog 0-10V outputs. A dedicated high-speed analog input is also provided, sampled at 2 kHz for near real-time control.
- **Included MagnaCTRL Software** Magna-Power's brand new MagnaCTRL Software comes standard with all SLx Series products, providing a modern, feature-rich, multi-product control platform. MagnaCTRL provides various Panels to allow for computer-based control, monitoring, sequencing, and firmware update capabilities.
- **Made in the USA, Available Worldwide** MagnaDC programmable DC power supplies are designed and manufactured at Magna-Power's 73,500 sq-ft vertically integrated USA manufacturing facility in Flemington, New Jersey. From raw materials to the completed product, Magna-Power has insourced nearly the entire production process to maintain complete control of quality, cost, and build-time. Heat-sinks and various metal assemblies are machined through both automated CNC and EDM. Sheet metal is cut, punched, sanded, bent, and powder coated in-house. Magnetics are wound-to-order from validated designs based on a model's voltage and current. A full surface mount technology (SMT) with multiple stages of 3D automated optical inspection ensures high-quality printed circuit board assemblies. Finally, after assembly, products undergo comprehensive test and calibration, followed by an extended burn-in period. Products are sold directly from the factory and through distribution, with a service network around the world. [Tour Magna-Power's Manufacturing.](#)

2.2 Models

The following tables list the available models in the SLx Series MagnaDC power supply.

2.2.1 Model Ordering Guide

The following ordering guide defines how an SLx Series MagnaDC power supply is defined:

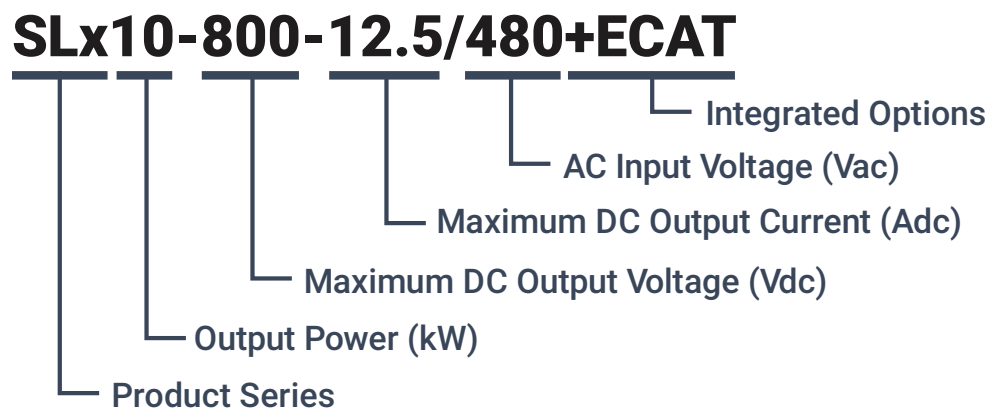

Fig. 2.1: SLx Series MagnaDC power supply Model Ordering Guide

2.2.2 1.5 kW SLx Series Models

Model	Maximum Voltage	Maximum Current	Ripple	Efficiency
SLx1.5-5-250	5 Vdc	250 Adc	30 mVrms	84%
SLx1.5-10-150	10 Vdc	150 Adc	30 mVrms	89%
SLx1.5-16-93	16 Vdc	93 Adc	40 mVrms	89%
SLx1.5-20-75	20 Vdc	75 Adc	40 mVrms	90%
SLx1.5-25-60	25 Vdc	60 Adc	50 mVrms	91%
SLx1.5-32-46	32 Vdc	46 Adc	60 mVrms	91%
SLx1.5-40-37	40 Vdc	37 Adc	80 mVrms	91%
SLx1.5-50-30	50 Vdc	30 Adc	70 mVrms	92%
SLx1.5-60-25	60 Vdc	25 Adc	100 mVrms	93%
SLx1.5-80-18	80 Vdc	18 Adc	120 mVrms	93%
SLx1.5-100-15	100 Vdc	15 Adc	120 mVrms	93%
SLx1.5-125-12	125 Vdc	12 Adc	110 mVrms	93%
SLx1.5-160-9	160 Vdc	9 Adc	110 mVrms	93%
SLx1.5-200-7.5	200 Vdc	7.5 Adc	110 mVrms	94%
SLx1.5-250-6	250 Vdc	6 Adc	110 mVrms	94%
SLx1.5-300-5	300 Vdc	5 Adc	160 mVrms	94%
SLx1.5-375-4	375 Vdc	4 Adc	160 mVrms	94%
SLx1.5-400-3.7	400 Vdc	3.7 Adc	170 mVrms	95%
SLx1.5-500-3	500 Vdc	3 Adc	250 mVrms	95%
SLx1.5-600-2.5	600 Vdc	2.5 Adc	250 mVrms	95%
SLx1.5-800-1.8	800 Vdc	1.8 Adc	350 mVrms	95%
SLx1.5-1000-1.5	1000 Vdc	1.5 Adc	400 mVrms	95%
SLx1.5-1250-1.2	1250 Vdc	1.2 Adc	700 mVrms	95%
SLx1.5-1500-1	1500 Vdc	1 Adc	1000 mVrms	95%

2.2.3 2.6 kW SLx Series Models

Model	Maximum Voltage	Maximum Current	Ripple	Efficiency
SLx2.6-10-250	10 Vdc	250 Adc	30 mVrms	89%
SLx2.6-16-162	16 Vdc	162 Adc	40 mVrms	89%
SLx2.6-20-130	20 Vdc	130 Adc	40 mVrms	90%
SLx2.6-25-104	25 Vdc	104 Adc	50 mVrms	91%
SLx2.6-32-81	32 Vdc	81 Adc	60 mVrms	91%
SLx2.6-40-65	40 Vdc	65 Adc	80 mVrms	91%
SLx2.6-50-52	50 Vdc	52 Adc	70 mVrms	92%
SLx2.6-60-43	60 Vdc	43 Adc	100 mVrms	93%
SLx2.6-80-32	80 Vdc	32 Adc	120 mVrms	93%
SLx2.6-100-26	100 Vdc	26 Adc	120 mVrms	93%
SLx2.6-125-20	125 Vdc	20 Adc	110 mVrms	93%
SLx2.6-160-16	160 Vdc	16 Adc	110 mVrms	93%
SLx2.6-200-13	200 Vdc	13 Adc	110 mVrms	94%
SLx2.6-250-10.4	250 Vdc	10.4 Adc	110 mVrms	94%
SLx2.6-300-8.6	300 Vdc	8.6 Adc	160 mVrms	94%
SLx2.6-375-6.9	375 Vdc	6.9 Adc	160 mVrms	94%
SLx2.6-400-6.5	400 Vdc	6.5 Adc	170 mVrms	95%
SLx2.6-500-5.2	500 Vdc	5.2 Adc	250 mVrms	95%
SLx2.6-600-4.3	600 Vdc	4.3 Adc	250 mVrms	95%
SLx2.6-800-3.2	800 Vdc	3.2 Adc	350 mVrms	95%
SLx2.6-1000-2.6	1000 Vdc	2.6 Adc	400 mVrms	95%
SLx2.6-1250-2	1250 Vdc	2 Adc	700 mVrms	95%
SLx2.6-1500-1.7	1500 Vdc	1.7 Adc	1000 mVrms	95%

2.2.4 4 kW SLx Series Models

Model	Maximum Voltage	Maximum Current	Ripple	Efficiency
SLx4-16-250	16 Vdc	250 Adc	40 mVrms	89%
SLx4-20-200	20 Vdc	200 Adc	40 mVrms	90%
SLx4-25-160	25 Vdc	160 Adc	50 mVrms	91%
SLx4-32-125	32 Vdc	125 Adc	60 mVrms	91%
SLx4-40-100	40 Vdc	100 Adc	80 mVrms	91%
SLx4-50-80	50 Vdc	80 Adc	70 mVrms	92%
SLx4-60-66	60 Vdc	66 Adc	100 mVrms	93%
SLx4-80-50	80 Vdc	50 Adc	120 mVrms	93%
SLx4-100-40	100 Vdc	40 Adc	120 mVrms	93%
SLx4-125-32	125 Vdc	32 Adc	110 mVrms	93%
SLx4-160-25	160 Vdc	25 Adc	110 mVrms	93%
SLx4-200-20	200 Vdc	20 Adc	110 mVrms	94%
SLx4-250-16	250 Vdc	16 Adc	110 mVrms	94%
SLx4-300-13.2	300 Vdc	13.2 Adc	160 mVrms	94%
SLx4-375-10.4	375 Vdc	10.4 Adc	160 mVrms	94%
SLx4-400-10	400 Vdc	10 Adc	170 mVrms	95%
SLx4-500-8	500 Vdc	8 Adc	250 mVrms	95%
SLx4-600-6.4	600 Vdc	6.4 Adc	250 mVrms	95%
SLx4-800-5	800 Vdc	5 Adc	350 mVrms	95%
SLx4-1000-4	1000 Vdc	4 Adc	400 mVrms	95%
SLx4-1250-3.2	1250 Vdc	3.2 Adc	700 mVrms	95%
SLx4-1500-2.6	1500 Vdc	2.6 Adc	1000 mVrms	95%

2.2.5 6 kW SLx Series Models

Model	Maximum Voltage	Maximum Current	Ripple	Efficiency
SLx6-20-250	20 Vdc	250 Adc	40 mVrms	90%
SLx6-25-240	25 Vdc	240 Adc	50 mVrms	91%
SLx6-32-186	32 Vdc	186 Adc	60 mVrms	91%
SLx6-40-150	40 Vdc	150 Adc	80 mVrms	91%
SLx6-50-120	50 Vdc	120 Adc	70 mVrms	92%
SLx6-60-100	60 Vdc	100 Adc	100 mVrms	93%
SLx6-80-75	80 Vdc	75 Adc	120 mVrms	93%
SLx6-100-60	100 Vdc	60 Adc	120 mVrms	93%
SLx6-125-48	125 Vdc	48 Adc	110 mVrms	93%
SLx6-160-36	160 Vdc	36 Adc	110 mVrms	93%
SLx6-200-30	200 Vdc	30 Adc	110 mVrms	94%
SLx6-250-24	250 Vdc	24 Adc	110 mVrms	94%
SLx6-300-20	300 Vdc	20 Adc	160 mVrms	94%
SLx6-375-16	375 Vdc	16 Adc	160 mVrms	94%
SLx6-400-15	400 Vdc	15 Adc	170 mVrms	95%
SLx6-500-12	500 Vdc	12 Adc	250 mVrms	95%
SLx6-600-10	600 Vdc	10 Adc	250 mVrms	95%
SLx6-800-7.5	800 Vdc	7.5 Adc	350 mVrms	95%
SLx6-1000-6	1000 Vdc	6 Adc	400 mVrms	95%
SLx6-1250-4.8	1250 Vdc	4.8 Adc	700 mVrms	95%
SLx6-1500-4	1500 Vdc	4 Adc	1000 mVrms	95%

2.2.6 8 kW SLx Series Models

Model	Maximum Voltage	Maximum Current	Ripple	Efficiency
SLx8-32-250	32 Vdc	250 Adc	60 mVrms	91%
SLx8-40-200	40 Vdc	200 Adc	80 mVrms	91%
SLx8-50-160	50 Vdc	160 Adc	70 mVrms	92%
SLx8-60-133	60 Vdc	133 Adc	100 mVrms	93%
SLx8-80-100	80 Vdc	100 Adc	120 mVrms	93%
Sx8-L100-80	100 Vdc	80 Adc	120 mVrms	93%
SLx8-125-64	125 Vdc	64 Adc	110 mVrms	93%
SLx8-160-50	160 Vdc	50 Adc	110 mVrms	93%
SLx8-200-40	200 Vdc	40 Adc	110 mVrms	94%
SLx8-250-32	250 Vdc	32 Adc	110 mVrms	94%
SLx8-300-26.4	300 Vdc	26.4 Adc	160 mVrms	94%
SLx8-375-21.3	375 Vdc	21.3 Adc	160 mVrms	94%
SLx8-400-20	400 Vdc	20 Adc	170 mVrms	95%
SLx8-500-16	500 Vdc	16 Adc	250 mVrms	95%
SLx8-600-13.3	600 Vdc	13.3 Adc	250 mVrms	95%
SLx8-800-10	800 Vdc	10 Adc	350 mVrms	95%
SLx8-1000-8	1000 Vdc	8 Adc	400 mVrms	95%
SLx8-1250-6.4	1250 Vdc	6.4 Adc	700 mVrms	95%
SLx8-1500-5.3	1500 Vdc	5.3 Adc	1000 mVrms	95%

2.2.7 10 kW SLx Series Models

Model	Maximum Voltage	Maximum Current	Ripple	Efficiency
SLx10-40-250	40 Vdc	250 Adc	80 mVrms	91%
SLx10-50-200	50 Vdc	200 Adc	70 mVrms	92%
SLx10-60-166	60 Vdc	166 Adc	100 mVrms	93%
SLx10-80-125	80 Vdc	125 Adc	120 mVrms	93%
SLx10-100-100	100 Vdc	100 Adc	120 mVrms	93%
SLx10-125-80	125 Vdc	80 Adc	110 mVrms	93%
SLx10-160-60	160 Vdc	60 Adc	110 mVrms	93%
SLx10-200-50	200 Vdc	50 Adc	110 mVrms	94%
SLx10-250-40	250 Vdc	40 Adc	110 mVrms	94%
SLx10-300-33.3	300 Vdc	33.3 Adc	160 mVrms	94%
SLx10-375-26.5	375 Vdc	26.5 Adc	160 mVrms	94%
SLx10-400-25	400 Vdc	25 Adc	170 mVrms	95%
SLx10-500-20	500 Vdc	20 Adc	250 mVrms	95%
SLx10-600-16.5	600 Vdc	16.5 Adc	250 mVrms	95%
SLx10-800-12.5	800 Vdc	12.5 Adc	350 mVrms	95%
SLx10-1000-10	1000 Vdc	10 Adc	400 mVrms	95%
SLx10-1250-8	1250 Vdc	8 Adc	700 mVrms	95%
SLx10-1500-6.6	1500 Vdc	6.6 Adc	1000 mVrms	95%

2.3 Specifications

2.3.1 AC Input Specifications

<p>Input Voltages Available Refer to models table for AC input voltage availability by power level AC Input voltage specified at time of order and cannot be modified</p>	<p>UI, 100-240 Vac, 1-phase UI2, 208-240 Vac, 1-phase 208 Vac, 3-phase 240 Vac, 3-phase 380/400 Vac, 3-phase 415 Vac, 3-phase 440 Vac, 3-phase 480 Vac 3-phase</p>
Input Voltage Tolerance	± 10%
Input Voltage Frequency	50-400 Hz
<p>Power Factor Measured at max power</p>	<p>> 0.99, 1-phase UI and UI2 AC inputs > 0.92, 3-phase AC inputs</p>
<p>Input Isolation Measured line-to-ground</p>	± 2000 Vdc

2.3.2 DC Output Specifications

Voltage Ripple	Model specific. Refer to models table.
Line Regulation	<p>Voltage control: ± 0.04% of rated voltage Current control: ± 0.03% of rated current Power control: ± 0.05% of rated power</p>
Load Regulation	<p>Voltage control: ± 0.02% of rated voltage Current control: ± 0.06% of rated current Power control: ± 0.08% of rated power</p>
<p>Stability FWHM, measured at 25°C over 8 hrs after 30 min warm-up</p>	<p>Voltage control: ± 0.005% of rated voltage Current control: ± 0.075% of rated current</p>

continues on next page

Table 2.2 – continued from previous page

Temperature Coefficient	Voltage control: 0.01%/°C of rated voltage Current control: 0.04%/°C of rated current Power control: 0.04%/°C of rated power
Efficiency	Up to 95%. Model specific. Refer to Models table.
Slew Rate, Voltage Standard models, programmable	Minimum (Slowest): Rated voltage x 2-15 [V/ms] Maximum (Fastest): Rated voltage x 0.006 [V/ms]
Slew Rate, Current Standard models, programmable	Minimum (Slowest): Rated current x 2-15 [A/ms] Maximum (Fastest): Rated current x 0.008 [A/ms]
Slew Rate, Power Standard models, programmable	Minimum (Slowest): Rated power x 2-15 [W/ms] Maximum (Fastest): Rated power x 0.004 [W/ms]
Output Isolation Measured output-to-ground	± 2000 Vdc

2.3.3 Programming Specifications

Resolution, Digital Programming Front panel or communication interfaces	16-bit, 0.00153% of rated voltage, current or power
Accuracy, Digital Programming Output value to set point value, programmed via front panel or communication interfaces	Voltage: ± 0.06% of rated voltage Current: ± 0.06% of rated current Power: ± 0.10% of rated power
Accuracy, Digital Measurement Output value to returned value, via front panel display or communication interfaces	Voltage: ± 0.08% of rated voltage Current: ± 0.08% of rated current Power: ± 0.10% of rated power

continues on next page

Table 2.3 – continued from previous page

Resolution, Analog Programming 0-10 V analog input	12-bit, 0.025% of rated voltage, current or power
Accuracy, Analog Programming Output value to set point value, programmed via analog input	Voltage: $\pm 0.12\%$ of rated voltage Current: $\pm 0.08\%$ of rated current Power: $\pm 0.10\%$ of rated power
Accuracy, Analog Programming, High Speed Input Output value to set point value, programmed via the high-speed analog input	Voltage: $\pm 0.80\%$ of rated voltage Current: $\pm 0.80\%$ of rated current Power: $\pm 1.20\%$ of rated power
Accuracy, Analog Measurement Output value to returned value, via analog output	Voltage: $\pm 0.08\%$ of rated voltage Current: $\pm 0.08\%$ of rated current Power: $\pm 0.10\%$ of rated power
Analog I/O 3 configurable standard analog inputs, 1 configurable high-speed analog input, reference signal provided	High-Speed Input Sampling Rate: 2 kHz Programming Voltage: 0-10 V Monitoring Voltage: 0-10 V, 3 mA capacity Monitoring Impedance: 0.005 Ω Reference Voltage: 10 V, 20 mA capacity

2.3.4 Interface Specifications

Front Panel Programming	Machined aluminum rotary knob with encoder, keypad, and up-down arrow for single bit control
Communication Interfaces Standard	USB Host (Front): Type B USB Host (Rear): Type B RS485 (Rear): RJ-45 MagnaLINK™: RJ-25 x 2

continues on next page

Table 2.4 – continued from previous page

External User I/O Port Standard	26-pin D-sub DB-26, female Referenced to ground; isolated from the DC output See User Manual for pin layout
Communication Interfaces Optional	CANopen (+CAN): RJ-45 x 2 EtherCAT (+ECAT): RJ-45 x 2 EtherNet/IP (+EIP): RJ-45 x 2 LXI TCP/IP Ethernet (+LXI): RJ-45 ModbusTCP (+MTCP): RJ-45 x 2 PROFINET (+PROF): RJ-45 x 2

2.3.5 Physical Specifications

Size All models	1U 1.75" H x 19" W x 24" D (4.4 x 48.3 x 61.0 cm)
Weight	1.5 kW models: 32 lbs (14.52 kg) 2.6 kW models: 34 lbs (15.42 kg) 4 kW models: 35 lbs (15.88 kg) 6 kW models: 35 lbs (15.88 kg) 8 kW models: 36 lbs (16.33 kg) 10 kW models: 36 lbs (16.33 kg)
Racking Standard	EIA-310
Rear Support Rails	Included

2.3.6 Environmental Specifications

Ambient Operating Temperature	0°C to 50°C
Storage Temperature	-35°C to +85°C
Humidity	Relative humidity up to 95% non-condensing
Air Flow	Side air inlet, rear exhaust

2.3.7 Regulatory Specifications

EMC	Complies with 2014/30/EU (EMC Directive) CISPR 22 / EN 55022 Class A
Safety	Complies with EN61010-1 and 2014/35/EU (Low Voltage Directive)
CE Mark	Yes
RoHS Compliant	Yes
REACH Compliant	Yes

INSTALLATION

3.1 Inspection

Carefully unpack the MagnaDC power supply and accessories saving all packing materials and included enclosures. Inspect the product for possible shipping damage. Check that there are no broken knobs or connectors, the external surface is not scratched or dented, the meter faces are not damaged, and all controls move freely. Any external damage may be an indication of internal damage. If there is any damage, notify the shipping carrier and [Magna-Power](#) immediately.

The following parts are included with all MagnaDC power supply models:

- SLx Series MagnaDC power supply
- Qty (2) rear support rack mounting brackets (Item 36120)
- SLx Series hardware pack
 - Qty (9) PTH-10-32-0.500 (#10-32 x 1/2”), TC Screw for front and rear support ears (Item 17054)
 - Qty (5) NF-10-0.437 Washer for rear support ears (Item 15638)
 - Qty (5) PPNH-08-32-0.500, SEMS Screw for rear support rails (Item 37170)
 - Qty (5) F-08-0.380 Washer for rear support rails (Item 12137)
 - Qty (4) PPNH-06-32-0.380, SEMS Screw for DC output cover (Item 25478)
 - Qty (4) F-06-0.380 Washer for DC output cover (Item 12136)
 - Qty (5) PFH-08-32-0.500, SS, WC Screw for front panel handles (Item 13790)
- Qty (2) Front panel handles 1.25” center, 0.25” wide, with mating hardware (Item 22015)
- Protective cover for DC output terminals (Item 35140)
- Phoenix Contact, female connector for AC input
 - Models with 1-phase UI or UI2 AC input: Phoenix Contact 1777846 (Item 36803)
 - Models with 3-phase AC input, except 10 kW models with 208/240 Vac input: Phoenix Contact 1777859 (Item 35239)
 - 10 kW Models with 3-phase 208/240 AC input: Phoenix Contact 1967472 (Item 35328)
- Calibration Certificate with Declaration of Conformity

3.2 Rack Installation

All SLx Series MagnaDC power supply models are intended for rack-mount installation, designed to fit in a standard 19" EIA-310-D equipment racks. When installing into a rack, both front and rear support is required. Fixed rear support rails are provided, which can be adjusted at time of installation to fit a variety of equipment rack depths, up to 32" (81.3 cm) from front vertical rack rail to rear vertical rack rail. These included support rails are designed to mate to inserts on the SLx Series MagnaDC power supply side panels using included hardware.

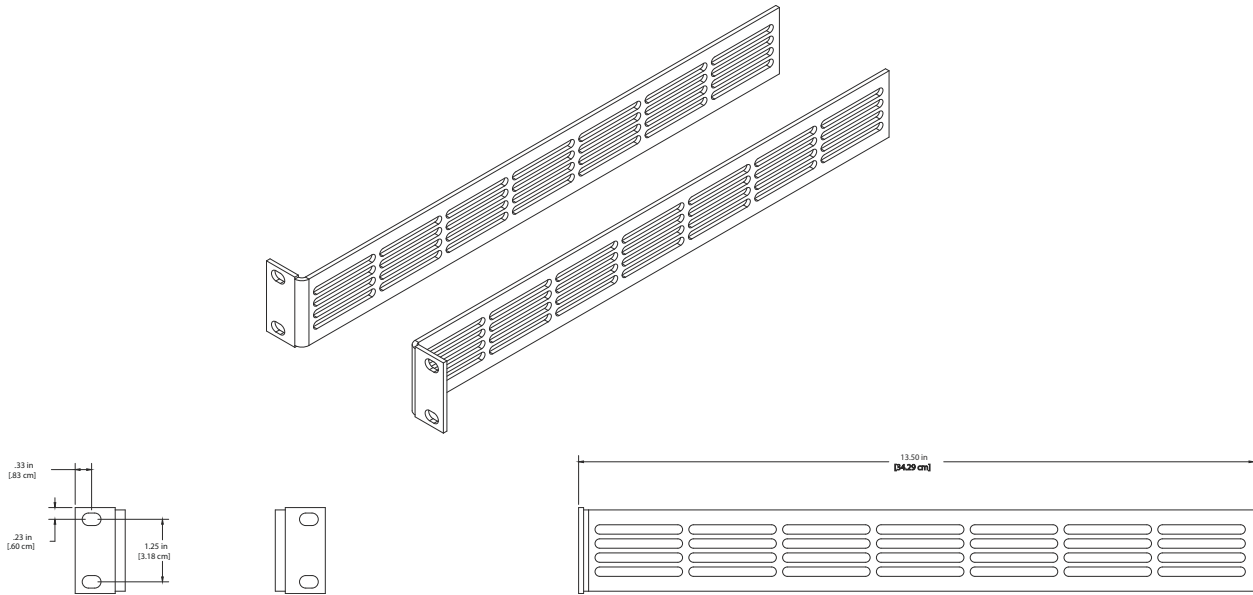

Fig. 3.1: Included rear support rails for the SLx Series

Note: Mechanical supports and cooling airflow for the SLx Series MagnaDC power supply are designed for horizontal installation only. Alternative mounting orientations are not recommended.

The following steps, which reference [Fig. 3.2](#), should be followed when installing SLx Series MagnaDC power supply products into a rack:

1. Install 8 clip nuts on the rack frame (not provided). There are 4 front support locations and 4 rear support locations.
2. Secure the rear rails in the back of the rack by securing the rear rail mounting ears to the rear clip nuts using the #10-32 x 1/2" screws (Item 17054); 4 total.
3. While supporting the MagnaDC power supply, secure the rear side panel mounting holes to the fixed rear rails using the #8-32 x 1/2" screws (Item 37170) with the #8 3/8" flat washers (Item 12137); 4 total.
4. While supporting the MagnaDC power supply, secure the front ears to front of the rack by securing front mounting ears to the front clip nuts using the #10-32 x 1/2" screws (Item 17054); 4 total.
5. Make necessary AC and DC power connections (see below) and attach DC output cover by attaching #6-32 x 3/8" screws (Item 13790) with #8 3/8" washers (Item 12136); 3 total.

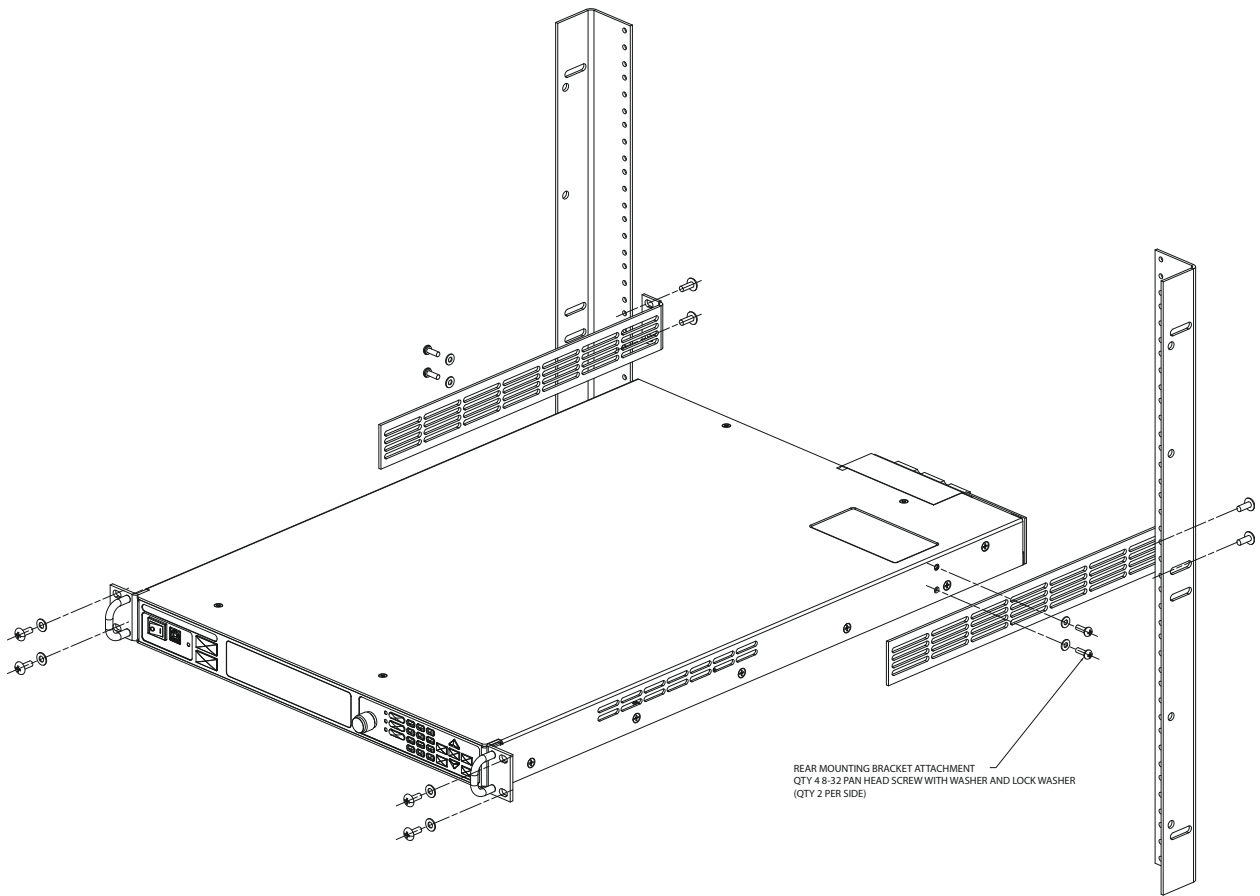

Fig. 3.2: Rack mount installation diagram for the SLx Series

3.2.1 Cooling Requirements

The SLx Series MagnaDC power supply features integrated fans that pull cool air in from the sides and exhausts warm air from the rear. This airflow allows two or more SLx Series MagnaDC power supply to be stacked without any vertical clearance required and to avoid pulling in pollutants from the room with suitable air filtration or conditioning on the equipment rack’s air intake. Equipment racks should be equipped with fans or blowers to remove heat generated by the power supplies. Equipment racks housing the SLx Series MagnaDC power supply should be equipped with either an open back, back with grills, or closed back with cabinet fans to remove heat generated by the SLx Series MagnaDC power supply. Magna-Power recommends fresh air intake at the bottom of the cabinet and exhaust fans at the top pulling air out of the cabinet.

For cabinet fans to be effective, the ambient intake air temperature outside the rack must be less than the air temperature inside the rack. The SLx Series MagnaDC power supply is rated for 50°C ambient operating temperature. In the case of rack installation, this corresponds to the temperature inside the rack and adequate cooling measures must be taken to ensure the rack’s internal temperature stays below 50°C.

The following table provides Magna-Power’s recommended per unit cabinet air flow when installing the SLx Series MagnaDC power supply in a fully enclosed cabinet, with example room temperatures at 25°C and 40°C:

SLx Series Model Power Level	Maximum Heat Produced	Recommended Cabinet Air Flow 77 °F (25 °C) Room Temperature	Recommended Cabinet Air Flow 104 °F (40 °C) Room Temperature
1.5 kW	0.5 kBTU/hr	15 CFM	35 CFM
2.6 kW	0.9 kBTU/hr	25 CFM	65 CFM
4 kW	1.4 kBTU/hr	25 CFM	80 CFM
6 kW	2.1 kBTU/hr	50 CFM	120 CFM
8 kW	2.7 kBTU/hr	65 CFM	160 CFM
10 kW	3.4 kBTU/hr	80 CFM	200 CFM

Note: The table above accounts for only a single product at each respective power level. When sizing cabinet fans, it is necessary to account for the heat produced by all the products in the cabinet.

Caution: Do not block the air intake on the sides of the product, nor the exhaust at the rear of the product. Blocking these vents could cause the product to overheat. The recommended minimum clearances are 2 inches (5.1 cm) along the sides and back.

Note: The product is equipped with thermocouples to monitor temperatures inside the product. In the event internal temperatures are exceeded due to excessive internal temperature, the product will shutdown and an over-temperature fault will be displayed.

3.3 AC Input Connection

Warning: Before attempting any installation or decommissioning procedure, disconnect AC power from the mains and ensure 0 Vac is measured from the AC input terminals to ground.

The SLx Series MagnaDC power supply uses a Phoenix Contact internal header and a provided Phoenix Contact mating connector to create a secure and finger-safe AC connection to the product. The SLx Series MagnaDC power supply is phase orientation insensitive, allowing the phases to be connected in any order. The ground connection must be connected to the position labeled with a ground *symbol*; ground is the rightmost connection on the AC input header.

Note: Products with a three phase AC input require all three phases to operate. These products cannot be operated with a single phase connection.

Warning: Never attempt to operate the product without a ground connection. Not connecting the ground is a safety hazard and could result in injury or death.

Magna-Power recommends AC cables sizes in accordance with the recommendations of the *National Electrical Code* or *Suggested Ampacities of 4-Conductor Type S or SO Cable*.

Note: The cable recommendations provided are for reference purposes only. Always consult local electrical code requirements to ensure compliance.

The AC wire should be stripped of 0.4" (10 mm) of insulation. The mating connector uses a Philips screw to secure the wire to the connector. After inserting each stripped wire into the connector, the corresponding Philips screw should be tightened to a torque of 0.5 Nm to 0.8 Nm.

After all AC input wires and the ground wire have been secured to the mating connector, insert the mating connector to the green AC header connection on the SLx Series MagnaDC power supply, indicated by the text AC INPUT. The mating connector is locked into place using a plastic flange. Additional, Philips screws are provided on both sides of the connector. Secure the mating connector to the header by tightening the screws on both sides to a torque of 0.3 Nm to 0.7 Nm.

Apply AC power to the product by connecting the disconnect or breaker to the mains. Measure each phase-to-phase (line-to-line) voltage to ensure they all measure within 10% of the products rated AC input voltage. Using an ohmmeter, measure to ground stud or any exposed metal screw to ground, ensuring it measures 0 Ohms indicating ground continuity.

Table 3.1: Suggested Ampacities of Various Conductors as Recommended by the National Electrical Code

Wire Size	60 °C Types	75 °C Types	85 °C Types	90 °C Types
	RUW, T, TW	FEPW, RH, RH, RUH, THW, THWN, XHHW, ZW	V, MI	TA, TBS, SA, AVB, SIS, FEP, FEPB, RHH, THHN, XHHW
14 AWG	25 Aac	30 Aac	30 Aac	35 Aac
12 AWG	30 Aac	35 Aac	40 Aac	40 Aac
10 AWG	40 Aac	50 Aac	55 Aac	55 Aac
8 AWG	60 Aac	70 Aac	75 Aac	80 Aac

continues on next page

Table 3.1 – continued from previous page

Wire Size	60 °C Types	75 °C Types	85 °C Types	90 °C Types
6 AWG	80 Aac	95 Aac	100 Aac	105 Aac
4 AWG	105 Aac	125 Aac	135 Aac	140 Aac
3 AWG	120 Aac	145 Aac	160 Aac	165 Aac
2 AWG	140 Aac	170 Aac	185 Aac	190 Aac
1 AWG	165 Aac	195 Aac	215 Aac	220 Aac
10 AWG	195 Aac	230 Aac	250 Aac	260 Aac
20 AWG	225 Aac	265 Aac	290 Aac	300 Aac
30 AWG	260 Aac	310 Aac	335 Aac	350 Aac
40 AWG	300 Aac	360 Aac	390 Aac	405 Aac
250 MCM	340 Aac	405 Aac	440 Aac	455 Aac
300 MCM	375 Aac	445 Aac	485 Aac	505 Aac
350 MCM	420 Aac	505 Aac	550 Aac	570 Aac

Table 3.2: Suggested Ampacities of 4-Conductor Type S or SO Cable

Wire Size	Maximum Current
18 AWG	7 Aac
16 AWG	10 Aac
14 AWG	15 Aac
12 AWG	20 Aac
10 AWG	25 Aac
8 AWG	35 Aac
6 AWG	45 Aac
4 AWG	60 Aac
2 AWG	80 Aac

3.3.1 Fuse Rating

SLx Series MagnaDC power supplies contain a variety of power and control fuses. For MagnaDC power supply products with a 1-phase input, there are two (2) power fuses and two (2) control fuses. For MagnaDC power supply products with a 3-phase input, there are three (3) power fuses and two (2) control fuses. Table 3.3 provides the fuses ratings and recommended replacements. Due to in-rush current limiting circuitry in the SLx Series MagnaDC power supply, current draw will not exceed the maximum current rating, even under start-up, allowing for the use of either fast- or slow-blow fuses.

In the event of a fuse fault, AC power must be disconnected from the product and the fuse must be replaced to correct this condition. A cleared power fuse usually indicates a power stage failure, often requiring factory attention. In addition, a cleared fuse can be caused by power surges from lightning storms or other AC transient events.

Warning: To avoid personal injury or damage to the SLx Series MagnaDC power supply, use only the specified replacement fuses.

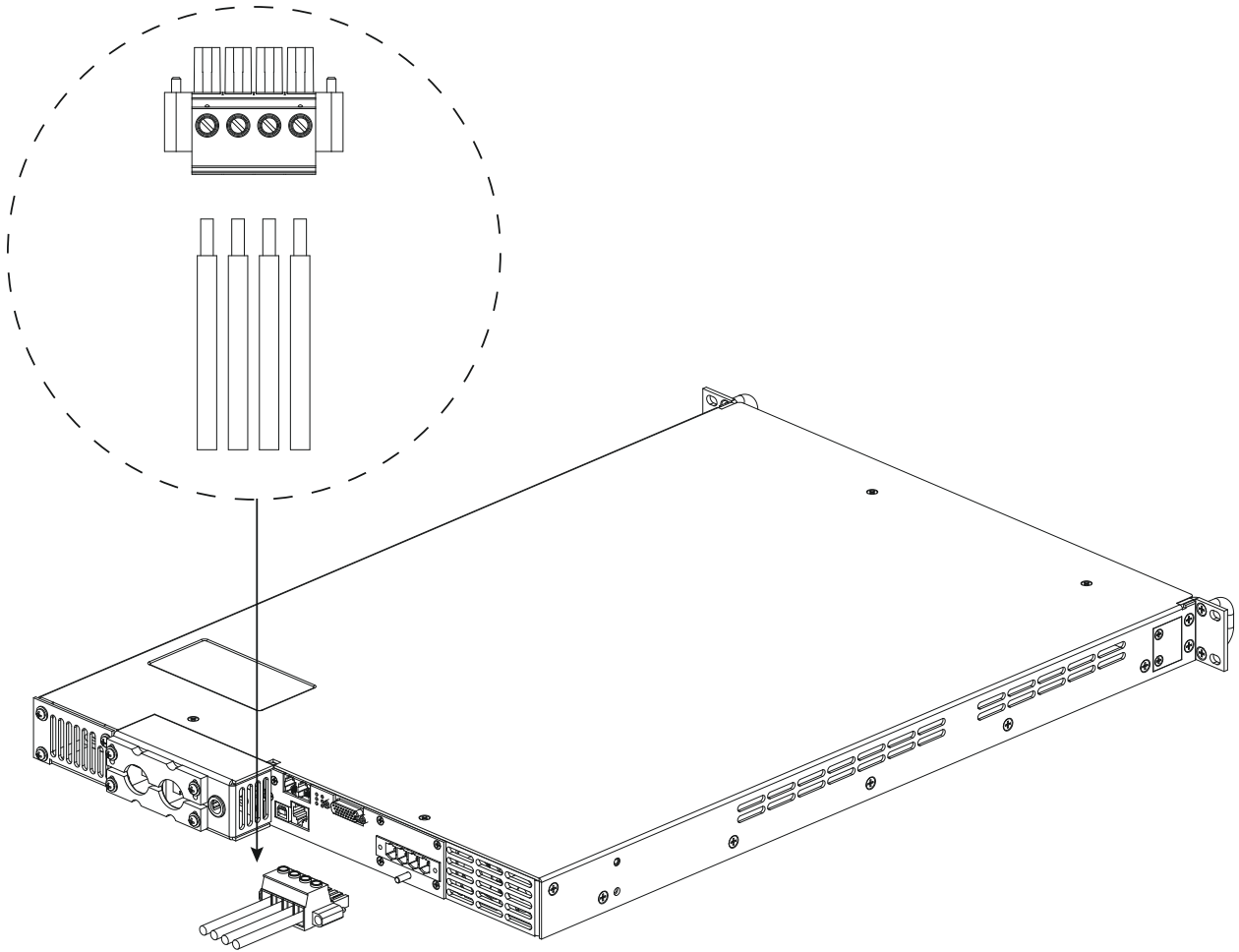

Fig. 3.3: AC input connection for SLx Series MagnaDC power supply

Table 3.3: Fuse ratings for SLx Series MagnaDC power supply

Power Level	AC Input Voltage	Power Fuse Rating	Recommended Power Fuse(s)	Control Fuse Rating	Recommended Control Fuse
1.5 kW	85-265 Vac (UI) 1-Phase	Qty (2) at 25 Aac ea.	FNQ25	Qty (2) at 1 Aac ea.	FNQ1
1.5 kW	208/240 3-Phase Vac	Qty (3) at 8 Aac ea.	FNQ8	Qty (2) at 1 Aac ea.	FNQ1
1.5 kW	380/415 3-Phase Vac	Qty (3) at 5 Aac ea.	FNQ5	Qty (2) at 1 Aac ea.	FNQ1
1.5 kW	440/480 3-Phase Vac	Qty (3) at 5 Aac ea.	FNQ5	Qty (2) at 1 Aac ea.	FNQ1
2.6 kW	187-265 1-Phase Vac	Qty (2) at 25 Aac ea.	FNQ25	Qty (2) at 1 Aac ea.	FNQ1
2.6 kW	208/240 3-Phase Vac	Qty (3) at 15 Aac ea.	FNQ15	Qty (2) at 1 Aac ea.	FNQ1
2.6 kW	380/415 3-Phase Vac	Qty (3) at 8 Aac ea.	FNQ8	Qty (2) at 1 Aac ea.	FNQ1
2.6 kW	440/480 3-Phase Vac	Qty (3) at 8 Aac ea.	FNQ8	Qty (2) at 1 Aac ea.	FNQ1
4 kW	208/240 3-Phase Vac	Qty (3) at 20 Aac ea.	FNQ20	Qty (2) at 1 Aac ea.	FNQ1
4 kW	380/415 3-Phase Vac	Qty (3) at 10 Aac ea.	FNQ10	Qty (2) at 1 Aac ea.	FNQ1
4 kW	440/480 3-Phase Vac	Qty (3) at 10 Aac ea.	FNQ10	Qty (2) at 1 Aac ea.	FNQ1
6 kW	208/240 3-Phase Vac	Qty (3) at 25 Aac ea.	FNQ25	Qty (2) at 1 Aac ea.	FNQ1
6 kW	380/415 3-Phase Vac	Qty (3) at 15 Aac ea.	FNQ15	Qty (2) at 1 Aac ea.	FNQ1
6 kW	440/480 3-Phase Vac	Qty (3) at 15 Aac ea.	FNQ15	Qty (2) at 1 Aac ea.	FNQ1
8 kW	208/240 3-Phase Vac	Qty (3) at 35 Aac ea.	FNQ35	Qty (2) at 1 Aac ea.	FNQ1
8 kW	380/415 3-Phase Vac	Qty (3) at 20 Aac ea.	FNQ20	Qty (2) at 1 Aac ea.	FNQ1
8 kW	440/480 3-Phase Vac	Qty (3) at 20 Aac ea.	FNQ20	Qty (2) at 1 Aac ea.	FNQ1
10 kW	208/240 3-Phase Vac	Qty (3) at 40 Aac ea.	FNQ40	Qty (2) at 1 Aac ea.	FNQ1
10 kW	380/415 3-Phase Vac	Qty (3) at 25 Aac ea.	FNQ25	Qty (2) at 1 Aac ea.	FNQ1
10 kW	440/480 3-Phase Vac	Qty (3) at 20 Aac ea.	FNQ20	Qty (2) at 1 Aac ea.	FNQ1

3.4 DC Output Connection

Warning: Shock Hazard Turn off AC power before making any rear panel connections. Ensure that MagnaDC power supply connections, load wiring, and load connections are either insulated or covered so that no accidental contact with lethal output voltages can occur.

The SLx Series MagnaDC power supply DC output connections are made by attaching cables to the output bus bars: one for the positive DC output connection and one for the negative DC output connection. Magna-Power recommends DC power cables be crimped to ring terminals and securely fastened to bus bars using the included 3/8" bolts, washers, and lock washers. The bus bars contain 3/8"-16 threaded inserts. The recommended torque for the DC connection is 15 lb-ft (20.3 Nm).

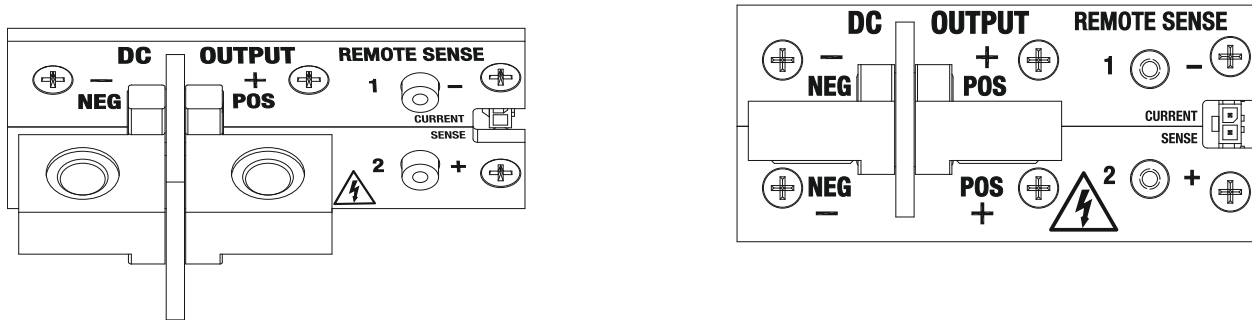

Fig. 3.4: DC output bus bars for SLx Series MagnaDC power supply

Magna-Power recommends selecting a wire size sufficient to handle the product's maximum output current rating, regardless of the intended load current or current set point.

The recommended wire size based on output current is shown in the table below.

Wire Size (USA)	Equivalent Wire Size (International)	Wires Per Output Terminal	Maximum Current
6 AWG	10 mm ²	1	85 Adc
4 AWG	25 mm ²	1	110 Adc
3 AWG	25 mm ²	1	130 Adc
2 AWG	35 mm ²	1	150 Adc
1 AWG	50 mm ²	1	170 Adc
1/0 AWG	50 mm ²	1	200 Adc
2/0 AWG	70 mm ²	1	235 Adc
3/0 AWG	95 mm ²	1	275 Adc
4/0 AWG	120 mm ²	1	315 Adc
1/0 AWG	50 mm ²	2	400 Adc
2/0 AWG	70 mm ²	2	470 Adc
3/0 AWG	95 mm ²	2	550 Adc
4/0 AWG	120 mm ²	2	630 Adc
1/0 AWG	50 mm ²	4	800 Adc
2/0 AWG	70 mm ²	4	940 Adc

continues on next page

Table 3.4 – continued from previous page

Wire Size (USA)	Equivalent Wire Size (International)	Wires Per Output Terminal	Maximum Current
3/0 AWG	95 mm ²	4	1100 Adc
4/0 AWG	120 mm ²	4	1260 Adc

Notes:

1. The current capacity for AWG wires derived from the National Electric Code. Maximum ambient temperature: 40°C. Maximum wire temperature: 90°C. Continuous duty with wires in free air, not bundled or in conduit.
2. The current capacity of aluminum wire is approximately 84% of the capacity listed for copper wire.
3. For higher current levels, it's recommended to use bus bars with holes for additional cable feeds or direct bus bar connection to the load.

Warning: FIRE HAZARD Select a wire size large enough to carry the SLx Series MagnaDC power supply model's maximum rated current to prevent overheating of the wires. Make sure power cable connections are secured tightly in accordance with the torque recommendation to prevent overheating of the bus bars.

3.4.1 Grounding the DC Output

The SLx Series MagnaDC power supply DC output is floating up to the DC output isolation specifications. A floating output means the output terminals are not electrically connected to ground and the produced output voltage is from the positive terminal with respect to the negative terminal. Neither output terminal needs to be connected to ground, however if desired, either the positive or negative terminal can be connected to earth ground.

3.5 Remote Sense Connection

Remote sensing can improve regulation at a remote reference point. For example, appreciable voltage drop can occur in the wire between the power supply and load as the current increases. By default, the load operates in local sense, where feedback is internally connected to the load's input terminals. However, the load can also operate in remote sense, and compensate for wire voltage drop by connecting its high-impedance sense wires to the power source terminals. When the remote sense setting is enabled the feedback measurements are taken from the remote sense leads.

The remote sense setting is accessible from either the *front panel* configuration or by *computer command*. Magna-Power recommends using 20 AWG wires with the remote sense screw terminals. Connect the MagnaDC power supply's positive remote sense lead to the positive of the DC source terminals. Connect the MagnaDC power supply's negative remote sense lead to the negative terminal of the DC source.

Caution: Always ensure that the positive remote sense lead corresponds to the positive DC bus and, likewise, the negative remote sense lead corresponds to the negative DC bus. Connecting sense wires with an incorrect polarity can result in equipment damage.

The MagnaDC power supply remote sense implements Smart Sense Detection, which shuts down and protects the product in the event that sense leads are disconnected while live or when the user leaves leads disconnected on start. Remote sense moves the feedback point external to the product. A floating sense connection creates a dangerous open-loop condition.

The MagnaDC power supply protects itself by monitoring both remote and local sense points continuously. When remote sense is enabled, the load will automatically switch from local sense to remote sense. The load stays in remote sense mode as long as the voltage difference between remote and local sense measurements is within $\pm 5\%$ of the MagnaDC power supply's rated voltage. When the load fails to achieve these operating condition, it enters into a soft fault and displays a remote sense loss message on the front display.

3.6 External User I/O Connection

The SLx Series MagnaDC power supply has a 25-pin External User I/O port located in the product's rear. The External User I/O connector is a standard female D-Sub 25-pin connector. The removable screw-locks provide means of securing mating connectors with commercially available 4-40 threaded hardware. The torque limit for the screw locks is 2 in-lb (0.23 N-m) applied from the mating face side. The maximum push out force is 20 lb-force (89 N) applied from the mating face side.

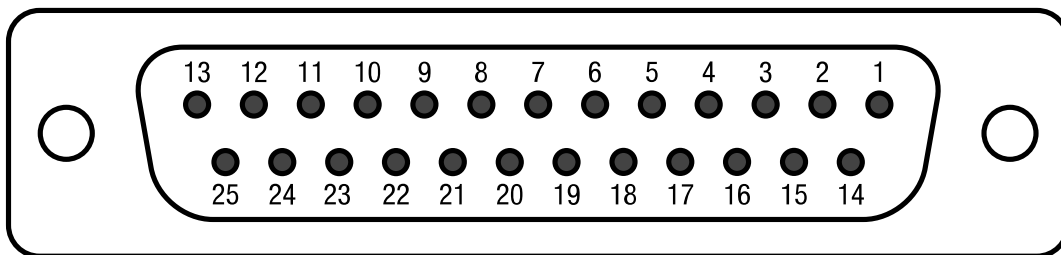

Fig. 3.5: External User I/O D-Sub 25-pin Connector and Pin Layout

3.7 Computer Connection

This section describes how to connect various communication interfaces to your MagnaDC power supply. Beyond installation, more detailed information about the communication interfaces and programming instructions is described in: *Operation: Computer Programming*. All available communication interfaces: USB, LXI TCP/IP Ethernet, and IEEE-488 GPIB interfaces operated on a shared bus; only one interface can be active at a time. If none of these interfaces are connected, the MagnaDC power supply defaults to RS485. The active communication interface is denoted in the front panel status menu display.

3.7.1 USB Interface

Universal Serial Bus (USB) interfaces are available on the front (USB2) and the rear (USB1) of the SLx Series MagnaDC power supply. Both accept USB Type B connectors and only one is active at a time. A particular port becomes active when a cable is plugged into USB connector and the other end is connected to a powered host. USB2 will always take precedence over USB1.

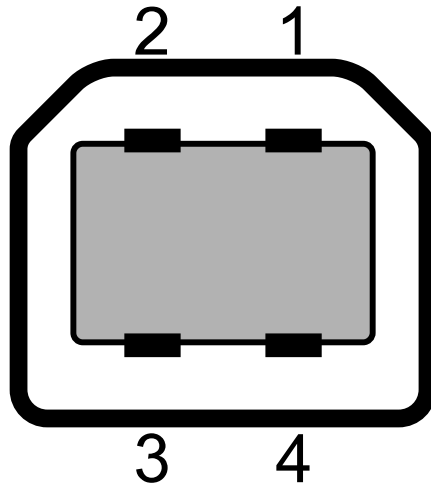

Fig. 3.6: USB Type B receptacle and pin layout

3.7.2 RS485 Interface

The SLx Series MagnaDC power supply supports RS485 communications through a RJ45 connector located on the rear communications panel, as shown in Fig. 3.7. The signals A (Data +), B (Data -), and GND are wired to pins 1, 2, and 7 of the RS485 RJ45 connector, respectively. The remaining pins are electrically disconnected. RS485 interface is always connected provided no other communication interface cables are connected.

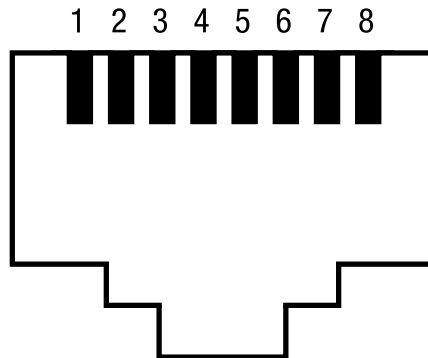

Fig. 3.7: RS485 RJ45 receptacle and pin layout

Note: Refer to the [ANSI/TIA-568 telecommunications standard](#) for the most common pin-to-pair assignments found on Ethernet cables: T568A and T568B.

3.7.3 Ethernet Interface

The SLx Series MagnaDC power supply supports a Ethernet option through a RJ45 connected located on the rear communication panel, as shown in Fig. 3.8. The LXI option activates after receiving its first *SCPI* command. At that point, the front display panel will show the interface change from either USB1, USB2, or RS485 to LXI. The only way to return to those interfaces is to power cycle the MagnaDC power supply. The LXI TCP/IP Ethernet interface, connector JS5, is detailed in *Ethernet Interface*.

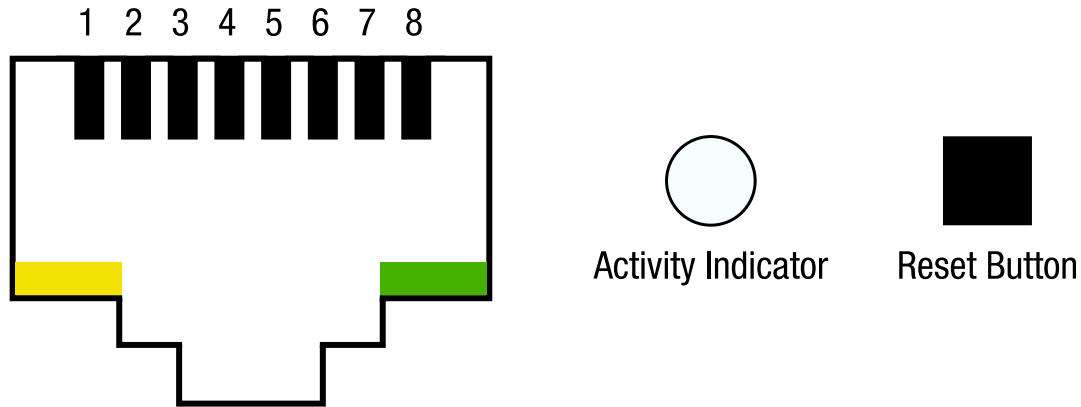

Fig. 3.8: LXI TCP/IP Ethernet RJ45 receptacle and pin layout

3.7.4 IEEE-488 GPIB Interfaces

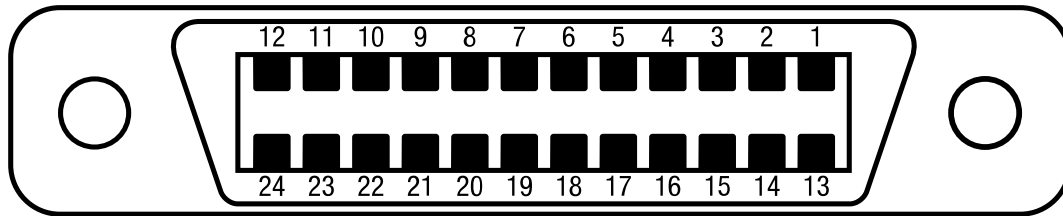

Fig. 3.9: IEEE-488 GPIB receptacle and Pin Layout

3.8 Electrical Check

Turn on the MagnaDC power supply using the black control power switch on the bottom left of the front panel. Immediately after turn-on, the MagnaDC power supply undergoes a self-test that check control and input circuitry. The Magna-Power emblem should be displayed during this self-test along with the the word MagnaDC power supply.

Note: After turning the unit on, it will take about 5 seconds for the MagnaDC power supply to initialize before it is ready for use.

When self-test is complete, the Menu display should show the unit's Standby status, the voltage meter should show whatever the DC bus voltage is, and the current meter should show *0.000*. The fans should be running at a low speed.

If the self test fails, the fans do not come on, or the unit fails to come into standby, power off the MagnaDC power supply off and back on with the black power switch. If you continue to have similar issues, contact *Magna-Power support* for further assistance.

FEATURES AND FUNCTIONS

4.1 Set-Points

Set-points are user reference values that describe the desired steady-state operation of the MagnaDC power supply. In combination with the feedback *Regulation States*, the difference between the set-point and corresponding measurements are driven to zero over time.

4.2 Commands

The SLx Series MagnaDC power supply features a variety of commands, which can all be accessed from the *front panel*, *external user I/O*, and *computer interface*.

4.2.1 Start

The Start command engages the MagnaDC power supply's DC input to allow the product to begin dissipating power, transitioning the *status* from Disabled to Enabled. The Start command switches the dissipative elements into of the DC circuit using a high-speed switching device.

4.2.2 Stop

The Stop command disengages the MagnaDC power supply's DC input to stop the product from dissipating power, transitioning the *status* from Enabled to Disabled. The Stop command switches the dissipative elements out of the DC bus using a high speed switching device.

Warning: Even when the Stop command is issued and the MagnaDC power supply's *status* is Disabled, there could still be hazardous voltages on the DC input from an externally connected DC source. Ensure that all instrument connections, load wiring, and load connections are either insulated or covered so that no accidental contact with lethal output voltages can occur. Always use a voltmeter to test the DC bus before making any connections.

4.2.3 Clear

The Clear command unlatches all soft-faults conditions and returns the MagnaDC power supply to standby, allowing the user to resume normal operation of the product. All soft-fault conditions must be resolved before clearing the latch. Once the fault has been cleared, the input can be re-enabled with the *Start command*.

4.2.4 Lock

The Lock command secures settings by locking the MagnaDC power supply, preventing changes to set-points and configuration settings through the front panel. When the MagnaDC power supply is locked, the *front panel* Lock button is back-lit red. In addition, the Lock status can be configured as one of the *external user I/O* digital outputs or queried by *computer interface*.

4.3 Function Generator

The function generator makes the SLx Series MagnaDC power supply sink current according to an internally generated waveform. This feature simplifies dynamic-load test setups since the generation is self contained and conveniently customized through the front panel menu system. Each of the function types available have a different signal-processing algorithm for accepting input parameters and outputting a periodic signal.

The function generator is enabled by choosing it as a *Setpoint Source* through menus *System Settings - Setpoint Source - Function Generator*. Once enabled, all set point changes from other sources are ignored. The generator algorithm, selected through menus *Function Generator - Function Type*, is subject to limitations of the sample rate and look-up table size. The algorithm can update at a rate of 0.5 ms. As such, the period is limited such that 4 samples are output per period (2 ms). The maximum period is restricted to 65000 ms. Set point related parameters (Amplitude, LoLevel, Offset, etc.) are limited to the product's rated current.

4.3.1 Sinusoid

The sinusoid function produces its waveform using the direct digital synthesis (DDS) method. Set points are loaded from a 1024 point sinusoid lookup table and scaled at fixed-sample intervals. The function is selected through menus *Function Generator - Function Type - Sinusoid*. The amplitude is set through menus *Function Generator - Function Type - Sinusoid Parameters - Amplitude(Adc)*. From the same parent menu, offset and period are set in menus *Offset(Adc)* and *Period(ms)*, respectively. These parameters and their effect on the waveform are illustrated in [Fig. 4.1](#).

4.3.2 Square

The square function produces its waveform by logically changing set points after a programmed period of time. The function is selected through menus *Function Generator - Function Type - Square*. The low-level set point is programmed through menus *Function Generator - Function Type - Square Parameters - LoLevel(Adc)*. From in the same parent menu, offset and period, in menus *Offset(Adc)* and *LoPeriod(ms)*, respectively, are programmed. These parameters and their effect on the waveform are illustrated in [Fig. 4.2](#).

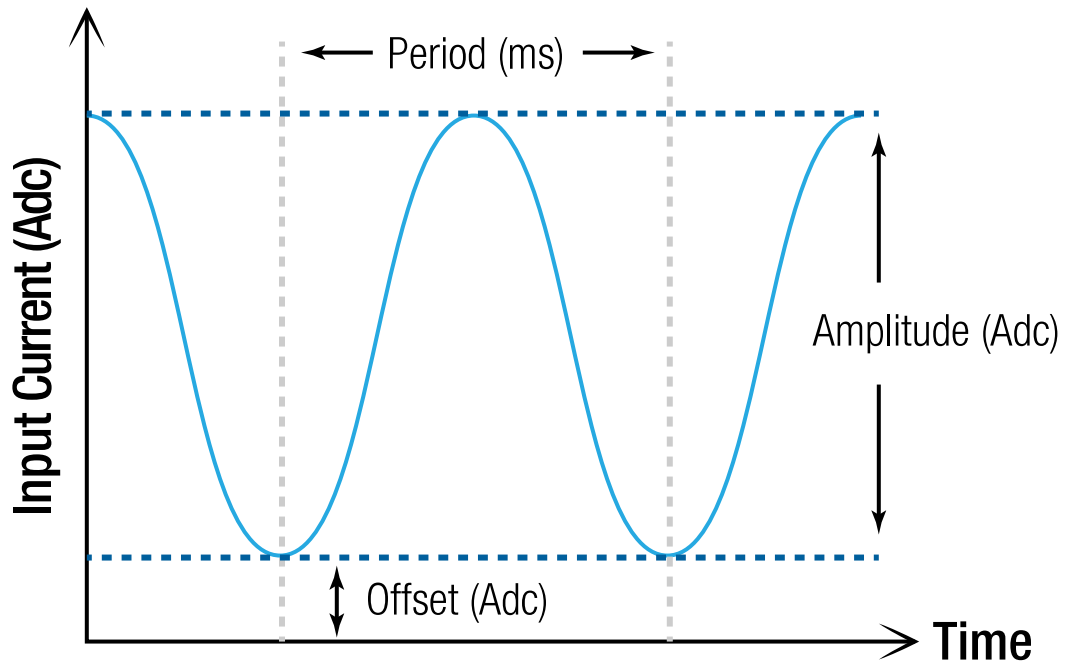

Fig. 4.1: Sinusoid Waveform Parameters

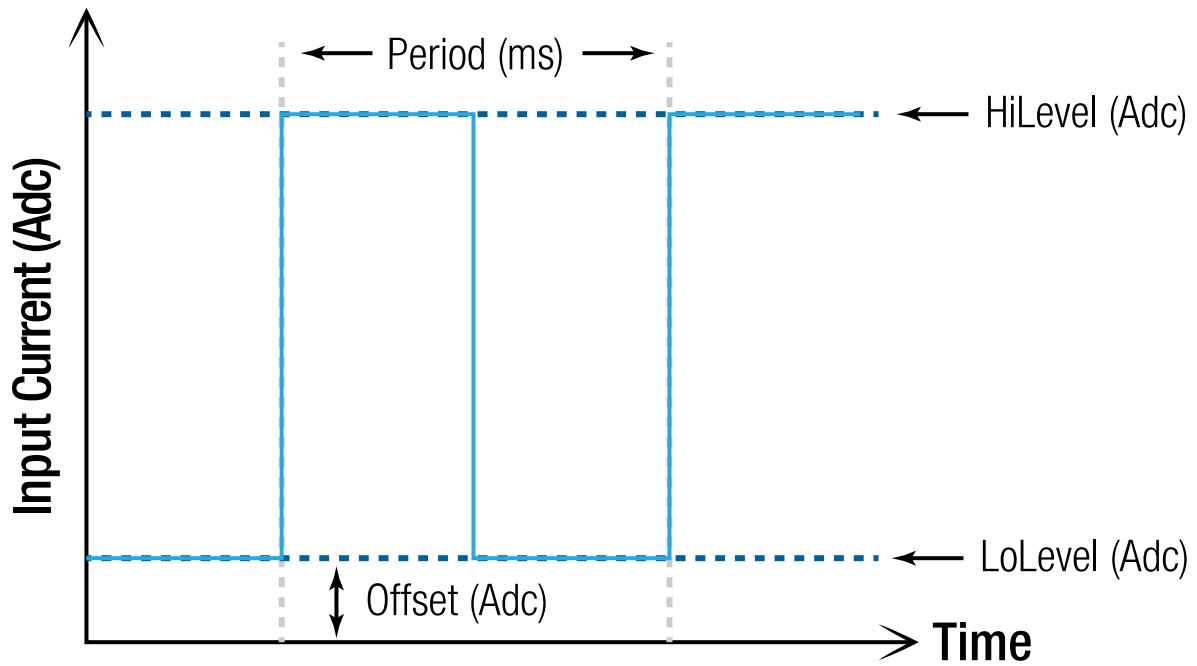

Fig. 4.2: Square Waveform Parameters

4.3.3 Step

The step function behaves similarly to the *Square Function*, but step points cycle manually by pressing the start button. The first time the start button is pressed, the MagnaDC power supply is enabled, and regulates to the parameter saved in *LoLevel(Adc)*. Pressing the start button again changes the set point to *HiLevel(Adc)*. Pressing the button a third time cycles back to *LoLevel(Adc)*. The parameter effects on the waveform are illustrated in Fig. 4.3.

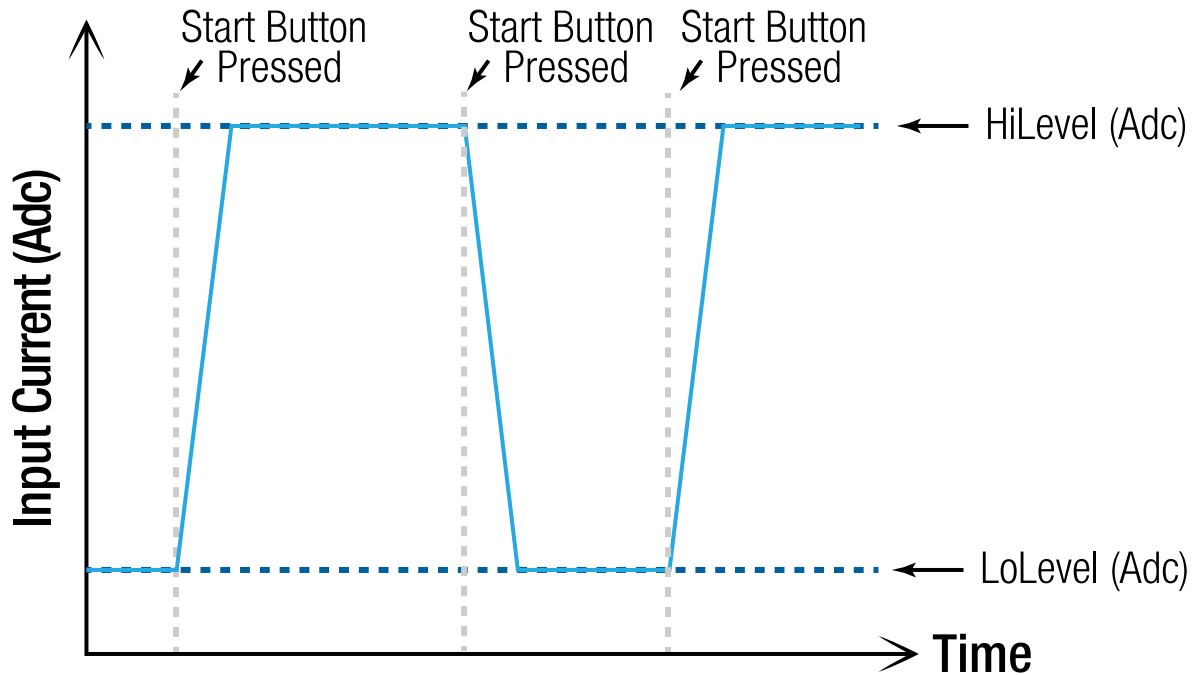

Fig. 4.3: Step Waveform Parameters

4.3.4 Ramp

The ramp function produces its waveform by logically changing set points after a programmed period of time, while maintaining specified rise and fall time. The function is selected through menu *Function Generator - Function Type - Ramp*. The low level set point is programmed through menu *Function Generator - Function Type - Ramp Parameters - LoLevel(Adc)*. From the same parent menu, the high level and rise and fall periods, *HiLevel(Adc)*, *RiseTime(ms)* and *FallTime(ms)*, are set respectively. These parameters and their effect on the waveform are illustrated in Fig. 4.4.

4.4 Control Modes

The SLx Series MagnaDC power supply automatically selects the appropriate *regulation state* depending on the selected control mode, programmed set-points and the voltage and current being driven by the connected DC source. The MagnaDC power supply preferences regulation states depending on the selected voltage, current, and power error.

Control Modes can be selected from the *front panel menu system* or by *computer command*. Changing the Control Mode while the DC input is enabled will cause the MagnaDC power supply to stop processing power and enter *Disabled* status.

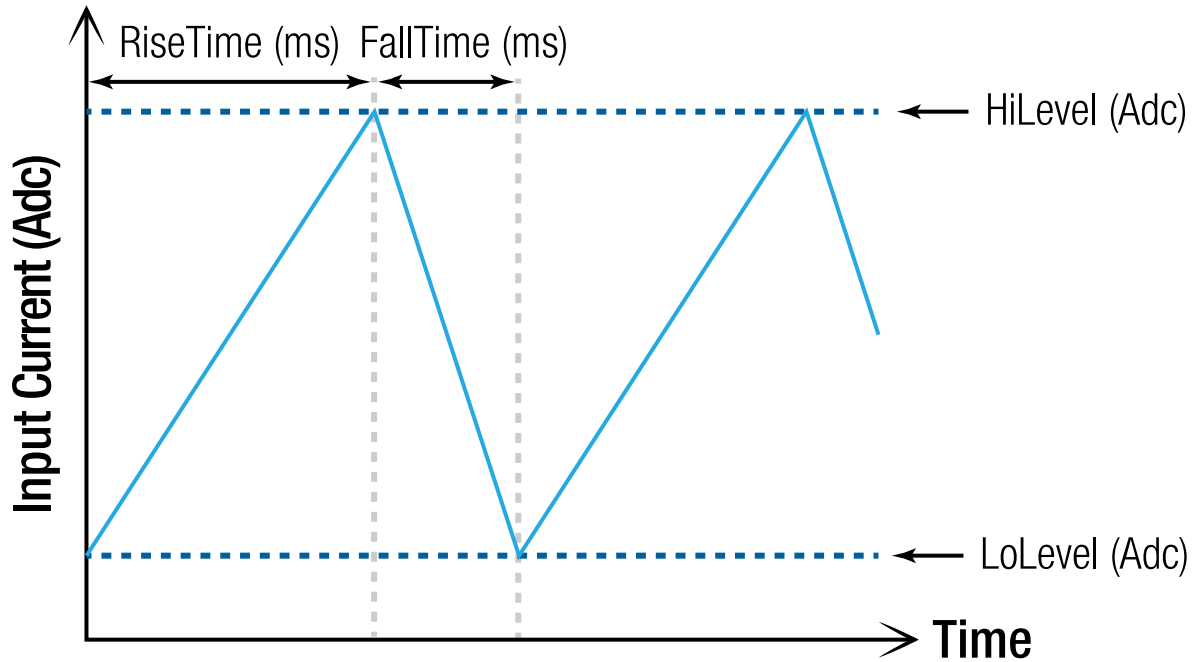

Fig. 4.4: Ramp Waveform Parameters

4.4.1 Auto-Crossover Mode

In auto-crossover, set-points define levels at which regulation states change. Whichever feedback error becomes negative, the corresponding regulation is activated.

As an example of auto-crossover, consider open-circuit condition. The starting regulation state for MagnaDC power supply is current regulation. The feedback current error will never become negative, causing the output to rise in voltage, and eventually surpassing the voltage set-point and regulation crossover to voltage regulation.

4.5 Regulation States

The SLx Series MagnaDC power supply has four regulation states: *Constant Voltage (CV)*, *Constant Current (CC)*, and *Constant Power (CP)*. The active regulation state is indicated by a illuminated circular LED next to the respective voltage, current, power, or resistance set-point button. The active regulation state can also be monitored programmatically.

4.5.1 Constant Voltage (CV)

When the constant voltage regulation state is indicated, the MagnaDC power supply is maintaining fixed voltage set-point, while the current fluctuates with the driving DC source, as illustrated by Fig. 4.5.

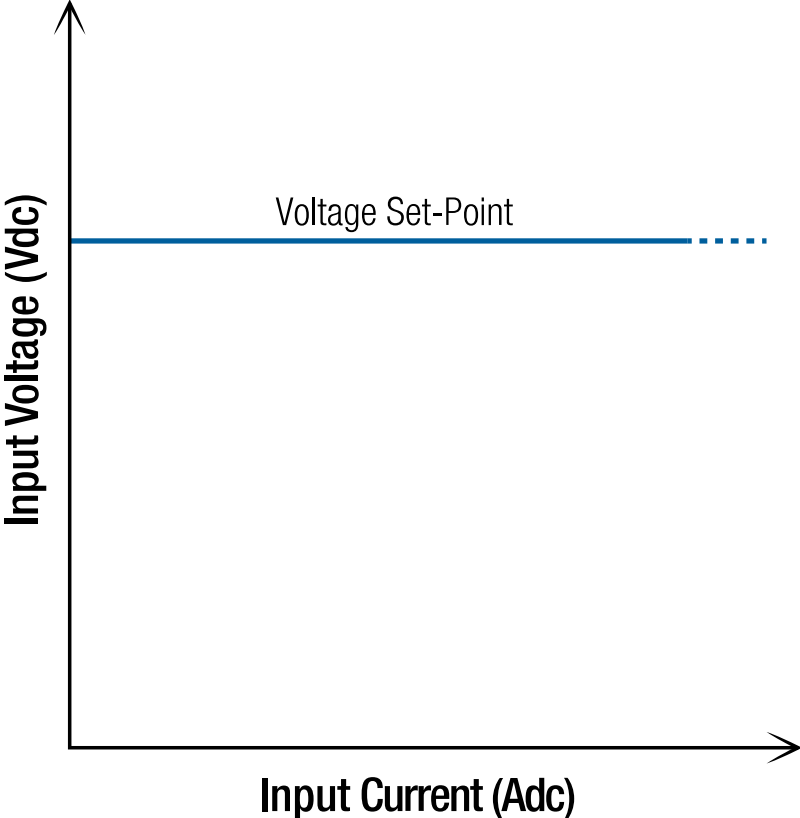

Fig. 4.5: Operating range in constant voltage mode

4.5.2 Constant Current (CC)

When the constant current regulation state is indicated, the MagnaDC power supply is maintaining a fixed current set-point, while the voltage fluctuates with the driving DC source, as illustrated by Fig. 4.6.

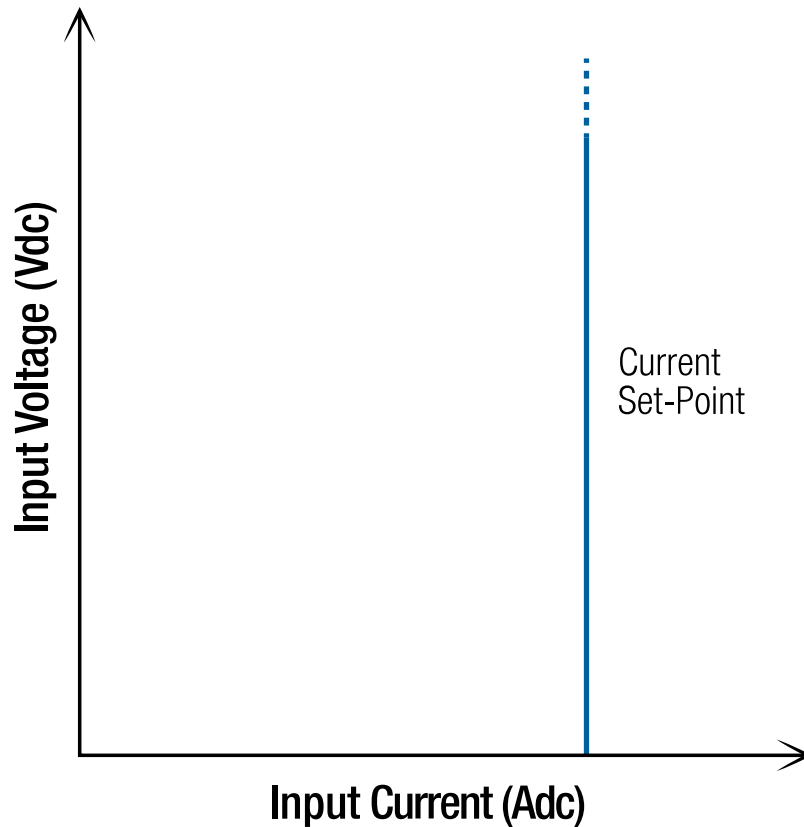

Fig. 4.6: Operating range in constant current mode

4.5.3 Constant Power (CP)

When the constant power regulation state is indicated, the MagnaDC power supply is maintaining a fixed power set-point by varying the current level inversely in response to a change in input voltage, as illustrated by Fig. 4.7.

4.6 Protection and Diagnostics

4.6.1 Over Voltage Trip (OVT)

The SLx Series MagnaDC power supply has a programmable Over Voltage Trip setting used to shutdown the product if an undesired maximum voltage value is measured across the DC input. The OVT setting can be adjusted to a maximum of 110% of the specific MagnaDC power supply's full scale voltage rating. An over-voltage condition must be sustained for multiple samples for the OVT fault to register.

When an OVT fault occurs, the DC input bus is disconnected via an internal switching device, leaving the MagnaDC power supply in an open-circuit faulted condition with an OVT alarm shown on the auxiliary display. To resume operation, the

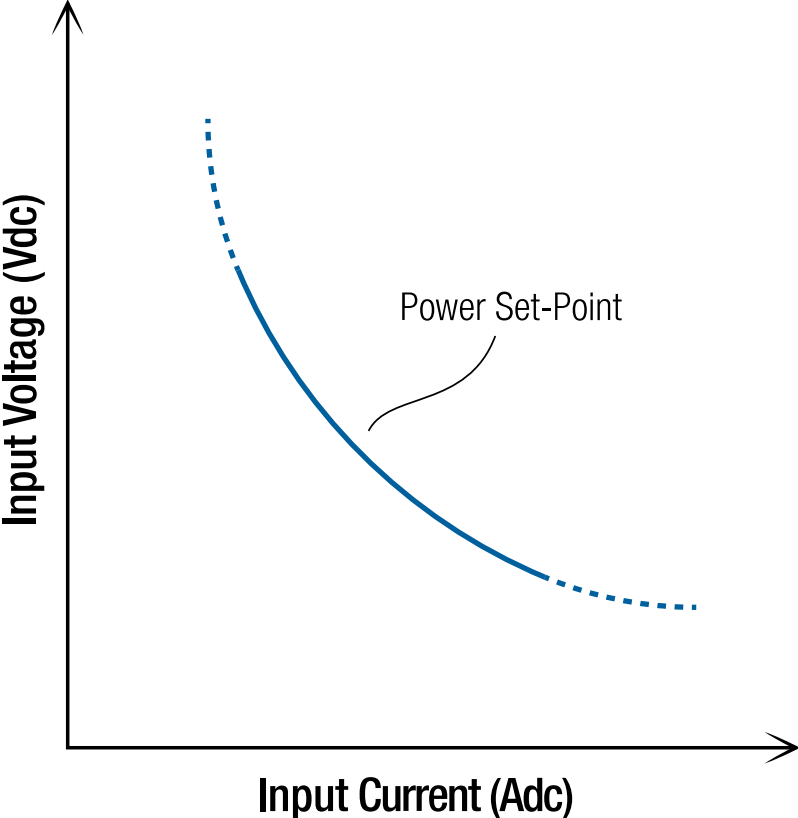

Fig. 4.7: Operating range in constant power mode

DC input voltage must be drop below the MagnaDC power supply's OVT setting, the *Clear* function must be issued, and the input re-energized with the *Start* function.

The OVT setting can be programmed through the front panel's auxiliary display, through one of the four analog inputs, or programmatically through software.

The factory default OVT setting is 110% of the specific MagnaDC power supply's maximum voltage rating.

4.6.2 Under Voltage Trip (UVT)

The SLx Series MagnaDC power supply has a programmable Under Voltage Trip setting used to shutdown the product if an undesired minimum voltage threshold is measured across the DC input. The UVT setting can be adjusted to a minimum of 5% of the specific MagnaDC power supply's full scale voltage rating. An under-voltage condition must be sustained for multiple samples for the UVT fault to register.

The UVT setting was designed to protect DC input sources, such as batteries, from discharging below a minimum desired voltage. If the UVT setting is used, upon first enabling the DC input the DC input voltage must be above the UVT setting or the MagnaDC power supply will trip immediately. Fig. 4.8 shows the operating range with both OVT and UVT enabled.

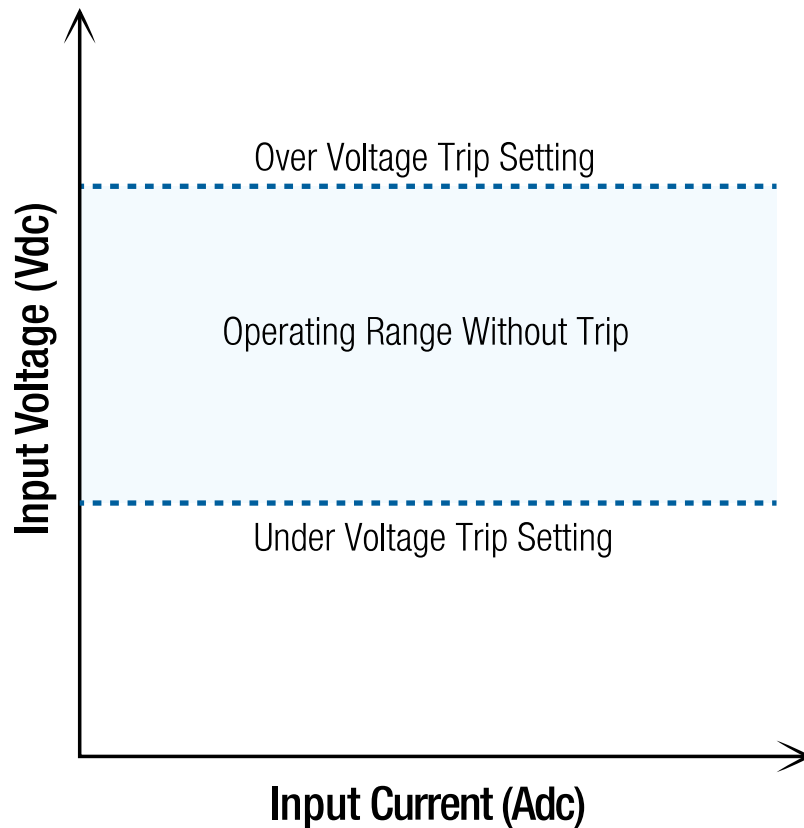

Fig. 4.8: Operating region without trip when OVT and UVT settings are enabled

When an UVT fault occurs, the DC input bus is disconnected via an internal switching device, leaving the MagnaDC power supply in an open-circuit faulted condition with an UVT alarm shown on the auxiliary display. To resume operation, the *Clear* function must be issued and the input re-energized with the *Start* function.

The UVT setting can be programmed through the front panel's auxiliary display, through one of the four analog inputs, or programmatically through software.

The factory default UVT setting is 0 Vdc, which disables the UVT protection.

4.6.3 Over Current Trip (OCT)

The SLx Series MagnaDC power supply has a programmable Over Current Trip setting used to shutdown the product if an undesired maximum current value is measured through the DC input. The OCT setting can be adjusted to a maximum of 110% of the specific MagnaDC power supply's full scale voltage rating. An over current condition must be sustained for multiple samples for the OCT fault to register.

When an OCT fault occurs, the DC input bus is disconnected via an internal switching device, leaving the MagnaDC power supply in an open-circuit faulted condition with an OCT alarm shown on the auxiliary display. To resume operation, the DC input current must be drop below the MagnaDC power supply's OCT setting, the *clear function* must be issued, and the input re-energized with the *start function*.

The OCT setting can be programmed through the front panel's auxiliary display, through one of the four analog inputs, or programmatically through software.

4.6.4 Over Power Trip (OPT)

The SLx Series MagnaDC power supply has a programmable Over Power Trip setting used to shutdown the product if an undesired maximum power value is measured at the DC input. The OPT setting can be adjusted to a maximum of 110% of the specific MagnaDC power supply's full scale power rating. An over-power condition must be sustained for multiple samples for the OPT fault to register.

When an OPT fault occurs, the DC input bus is disconnected via an internal switching device, leaving the MagnaDC power supply in an open-circuit faulted condition with an OPT alarm shown on the auxiliary display. To resume operation, the DC input voltage must be drop below the MagnaDC power supply's OPT setting, the *Clear* function must be issued, and the input re-energized with the *Start* function.

The OPT setting can be programmed through the front panel's auxiliary display, through one of the four analog inputs, or programmatically through software.

The factory default OPT setting is 110% of the specific MagnaDC power supply's maximum power rating.

4.6.5 Thermal Fault

The SLx Series MagnaDC power supply has internal thermistors on its various heatsinks to ensure operation at temperatures within the product's design specifications. A thermal fault typically results from one of the following conditions:

- Operating in an environment above the maximum ambient temperature specification.
- Operating in an environment below the minimum ambient temperature specification.
- Blocking the front panel air intake.
- Internal fan or solenoid failure.
- Broken electrical contact to thermistors.
- Coolant intake temperatures are above those recommended.

When a thermal fault occurs, the MagnaDC power supply enters into a hard-fault condition, where all loads disconnect from the source. The user is prevent from enabling the load through the front panel and external interfaces. Details about the thermal fault are shown on the front display.

To resume operation, the product must be power cycled, by toggling the rocker switch located on the front panel. Allow sufficient time for the MagnaDC power supply to return to safe operating temperatures. Otherwise, the product will enter immediately into a thermal fault after booting.

4.6.6 Interlock

The Interlock feature disables the MagnaDC power supply by entering a *soft fault* state. The safety feature is triggered whenever the +5V signal applied to the interlock pin is broken. By default, interlock is disabled when the MagnaDC power supply ships from the factory. Interlock can be enabled from the *front panel*, *computer interface*. Once interlock is assigned to one of the pins listed in *external user I/O* +5V must be present to operate the product. There are two method to providing +5V to the interlock pin:

- Providing a physical short from the provided *external user I/O* +5V signal (Pin 14) to the interlock digital input.
- Using an external user supplied +5V signal with reference to the *external user I/O* GND signal (Pin 25).

With either method, an external dry contact may be used to trigger the interlock.

When the +5V interlock signal is broken, the dissipative elements are switched out of the DC bus using a high-speed switching device, the MagnaDC power supply is placed in a *soft fault* state.

To resume normal operation, the +5V signal must first be restored to the interlock input and the *Clear command* issued.

4.6.7 Lock

The lock feature prevents inadvertent changes to MagnaDC power supply operation by disabling front panel button inputs. Lock can be enabled through the front panel using the LOCK button, through the communications interface using SCPI commands, and the rear-external interface using a +5V signal. In all cases, the LOCK button will illuminate to show the MagnaDC power supply is lock. Also, and the stop button always functions normally (for safety). The digital input lock takes highest priority, such that when locked, it can be unlocked only by the digital input. Second priority is SCPI followed by the LOCK button. The table below illustrates unlocking behavior for a locked MagnaDC power supply.

Table 4.1: Unlocking Priority

	Locked by Front Panel	Locked by SCPI	Locked by Digital Input
Front Panel Unlock	✓		
SCPI Unlock	✓	✓	
Digital Input Unlock			✓

4.6.8 User I/O Alarm

The SLx Series MagnaDC power supply monitors analog and digital input voltages on the 26-pin User I/O connections to ensure that they are within the each pin's respective voltage range. A User I/O alarm will be triggered in the event a voltage input on one of these pins exceeds 110% of the specific input's range, further described by the table below:

User I/O Pins	Description	Nominal Voltage Range	User I/O Alarm Voltage
11, 12, 23, 24	Digital Inputs	0 - 5 V	> 5.5 V
5, 6, 17, 18	Analog Inputs	0 - 10 V	> 11 V

When an User I/O fault occurs, the DC input bus is disconnected via an internal switching device, leaving the MagnaDC power supply in an open-circuit faulted condition with an User I/O alarm shown on the auxiliary display. To resume operation the input voltages on the 25-pin User I/O must return to the each pin's respective nominal input voltage range, the *Clear* function must be issued and the input re-energized with the *Start* function.

4.6.9 Emergency Stop (E-Stop)

The emergency stop (e-stop) is a hard-wired safety feature in the MagnaDC power supply that quickly and definitively cuts electrical power to both the control circuitry and power stages. When activated, the shutdown behavior mirrors that of switching the front panel rocker switch to the off position. The e-stop is triggered on loss of a 24 VDC input signal on the *external user I/O*, between pins 13 and 26.

By default, products leave the factory with the e-stop feature disabled. In this default state, the black rocker switch is the only means of turning the product on and off. To enable the e-stop feature, follow these steps:

1. Remove AC power to the product by either turning off the AC circuit breaker feeding the product or removing the green plug on the rear of the product labeled AC INPUT.
2. Switch the power rocker into the ON position.
3. Wait for 3 minutes allowing time for internally stored energy to discharge from the power circuits.
4. Unscrew the test access panel cover located on the left-hand side of the product, right behind the mounting ear.
5. Remove the black plastic jumper, JP1, situated at the top of the opening.
6. Reinstall the cover upon completion.

Warning: Failure to disconnect AC power and wait 3 minutes could result in electrical shock when accessing the assembly behind the test access panel.

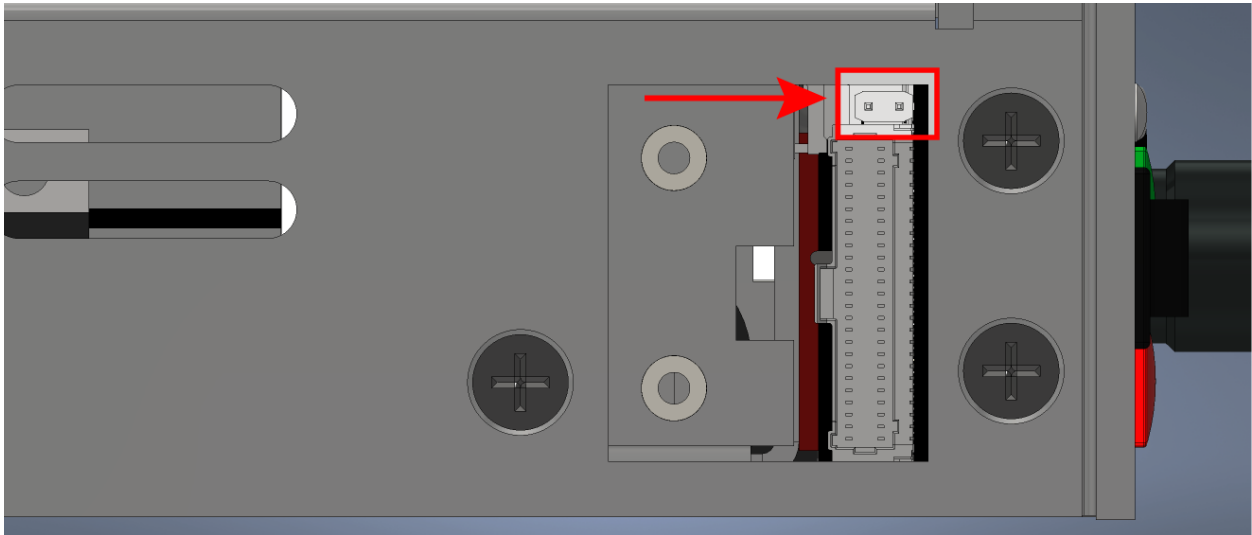

Fig. 4.9: Test access panel with protective cover removed and a red arrow to indicate e-stop jumper

The rocker, jumper, and e-stop (inputs) form a hard-wired electrical circuit. The resulting product state will depend on the input conditions as shown in the E-Stop Product State Table.

E-Stop Product State Table

E-Stop	Power Rocker	Jumper (JP1)	Product State
+24V	off	removed	off
+24V	on	removed	on
0V	off	removed	off
0V	on	removed	off
X	off	installed	off
X	on	installed	on

4.7 Statuses

The MagnaDC power supply has various statuses corresponding to its present state of operation. These statuses can be viewed on the *front panel*, programmatically by *computer command*, or using the *25-pin user I/O connector*. The available statuses are as follows:

Enabled The MagnaDC power supply's input is engaged and processing power.

Disabled The MagnaDC power supply's input is disengaged and all systems are normal. The MagnaDC power supply is awaiting a START command to engage its input. When in a Disabled state, there is an electrical disconnect between the product's dissipative elements and the DC input terminals through a high speed switching device.

Soft Fault The MagnaDC power supply's input is disengaged as a result of a soft fault that occurred. A soft fault occurs when an user-programmed limit is reached, such as a trip setting. A description of the soft fault is displayed on the *message* line. A soft fault can be cleared with the CLEAR function, placing the MagnaDC power supply into a Disabled status. When in a Soft Fault state, there is an electrical disconnect between the product's dissipative elements and the DC input terminals through a high speed switching device.

Hard Fault The MagnaDC power supply's input is disengaged as a result of a hard fault that occurred. A hard fault is a system shutdown resulting from an operating condition that has the potential to damage the product, for example, exceeding the products specifications. A description of the hard fault is displayed on the *message* line. A hard fault can only be cleared by power cycling the product. When in a Hard Fault state, there is an electrical disconnect between the product's dissipative elements and the DC input terminals through a high speed switching device.

Caution: Ignoring hard faults and repeatedly operating the MagnaDC power supply in a manner that triggers a hard fault will eventually result in product damage.

4.8 Status Messages

The MagnaDC power supply has various messages, which elaborate on the product's present *status*. A message may indicate normal operation, power limiting as a result of the MagnaDC power supply's operating profile, or steps to resolve a fault.

Messages for Status: Enabled

- Output enabled.

Messages for Status: Disabled

- Output disabled.

Messages for Status: Soft Fault

- Voltage exceeded the trip point. Press CLEAR to resume.
- Current exceeded the trip point. Press CLEAR to resume.
- Power exceeded the trip point. Press CLEAR to resume.
- Remote sense loss. Only 10 percent compensation is allowed. Press CLEAR to resume.
- Voltage has fallen below the trip point. Press CLEAR to resume.
- Global shutdown occurred.

Messages for Status: Hard Fault

- Global shutdown occurred.
- Chopper stage currents have exceeded product rating. Verify load does not exceed product ratings.
- Excessive communication errors detected. Check cabling and addressing resistors. Call technical support.
- Product has exceeded its voltage rating. Investigate the cause before retrying.
- Product has exceeded its current rating. Investigate the cause before retrying.
- The internal power supply has blown a fuse. Contact Magna-Power for support.
- Analog or Digital input voltage exceeded the max voltage specified. Investigate the cause before trying again.
- The AC input section has a blown fuse. Contact Magna-Power for support.
- One of the AC Input Phase is missing. Investigate the cause before retrying.
- One or more fan has stopped spinning. Investigate the cause before retrying.
- Power Processing module has exceeded its temperature rating. Check for input current rating and the ambient temperature.
- Output Filter module has exceeded its temperature rating. Check for ventilation blockages and the ambient temperature.
- Output Capacitors have exceeded their temperature rating. Check for output current ripple and the ambient temperature.

4.9 Factory Restore

The SLx Series MagnaDC power supply contains EEPROM (electrical erasable programmable read-only memory) for retaining settings after loss of AC power. The memory contains the set points, control mode, calibration gains, offsets, product serial numbers, and more. Most the memory positions are visible using MagnaCTRL under the “EEPROM Editor” side menu.

Factory Restore overwrites existing EEPROM settings with defaults values so the MagnaDC power supply can return to a known operating state. This should be performed if user experiences unexpected behavior, due to unknown or forgotten configurations. Magna-Power Electronics may request users perform factory restore, as a starting point in most support cases. The memory positions affected by factory restore are listed in the table below.

Factory restore values (defaults) can be stored in Flash or EEPROM memory, as determined by Magna-Power Electronics. The Flash values are used for product-wide settings, such as control mode and slew rates, and mostly affect the products operating state. EEPROM values are reserved for customer and unit-specific settings, such as gains, offsets, and MagnaLINK™ address information, which are set during factory testing.

Product can be restored to a known state, by modifying the EEPROM in bulk, using either *Soft Restore* or *Hard Restore*. Soft Restore only effects those EEPROM positions whose default values are stored in Flash, as shown in the table below. Hard Restore overwrites calibrations values, feedback gains, i.e., settings saved in EEPROM at the factory. In most cases,

Soft Restore should be used, and Hard Restore used as a last resort, since it overwrites any in-house calibrations with or original (older) factory calibrations.

Factory restore can be initiated using the front panel by navigating to *System Settings - Factory Restore* in the menu system. After the restore option has been selected, MagnaDC power supply will reboot and start up with the new settings.

Factory Restore Values

Name	Memory Type	Restore Value	Description
setPointReg0	flash	0	Current setpoint (normalized)
setPointReg1	flash	0	Voltage setpoint (normalized)
setPointReg2	flash	0	Power setpoint (normalized)
setPointReg3	flash	0	Resistance setpoint (normalized)
setPointReg4	flash	0	Rheostat setpoint (normalized)
tripOverVoltage	flash	1.1	Over Voltage Trip (normalized)
tripUnderVoltage	flash	0	Under Voltage Trip (normalized)
tripDelayVoltage	flash	0	Delay Voltage Trip (milliseconds)
tripOverCurrent	flash	1.1	Over Current Trip (normalized)
tripUnderCurrent	flash	0	Under Current Trip (normalized)
tripDelayCurrent	flash	0	Current Trip Delay (milliseconds)
tripOverPower	flash	1.1	Over Power Trip (normalized)
tripUnderPower	flash	0	Under Power Trip (normalized)
tripDelayPower	flash	0	Power Trip Delay (milliseconds)
tripOverResistance	flash	0	Over Resistance Trip (normalized)
tripUnderResistance	flash	0	Under Resistance Trip (normalized)
tripDelayResistance	flash	0	Resistance Trip Delay (milliseconds)
setpointSelect	flash	1	Last setpoint selected by user
controlMode	flash	1	Regulation control mode
rampRiseVoltage	EEPROM	factory determined	Voltage setpoint rise rate (1/s)
rampRiseCurrent	EEPROM	factory determined	Current setpoint rise rate (1/s)
rampRiseResistance	EEPROM	factory determined	Resistance setpoint rise rate (1/s)
rampRisePower	EEPROM	factory determined	Power setpoint rise rate (1/s)
rampFallVoltage	EEPROM	factory determined	Voltage setpoint rise fall (1/s)
rampFallCurrent	EEPROM	factory determined	Current setpoint rise fall (1/s)
rampFallResistance	EEPROM	factory determined	Resistance setpoint rise fall (1/s)
rampFallPower	EEPROM	factory determined	Power setpoint rise fall (1/s)
range	flash	0	Power range, controls behavior of bypassing resistor modules (LowPower:0, HighPower:1)

continues on next page

Table 4.2 – continued from previous page

Name	Memory Type	Restore Value	Description
idxHigh-SpeedAI	flash	0	Selection index that chooses which setpoint, high-speed analog-in signal is applied to.
functionType	flash	0	Function Type Selection. See EnumFunctionType for more details.
funcSineAmpl	flash	0.1	Sine Function Amplitude (normalized), applies to Current setpoint.
funcSineOffset	flash	0.5	Sine Function Offset (normalized), applies to Current setpoint.
funcSinePrd	flash	10	Sine Function Period in milliseconds
funcSqLoLevel	flash	0.1	Square Function Low Level (normalized), applies to Current setpoint.
funcSqHiLevel	flash	0.5	Square Function High Level (normalized), applies to Current setpoint.
funcSqLoPrd	flash	10	Square Function Low Period in milliseconds
funcSqHiPrd	flash	10	Square Function High Period in milliseconds
func-StepLoLevel	flash	0.1	Step Function Low Level (normalized), applies to Current setpoint.
func-StepHiLevel	flash	0.5	Step Function High Level (normalized), applies to Current setpoint.
funcRampLoLevel	flash	0.1	Ramp Function Low Level (normalized), applies to Current setpoint.
funcRampHiLevel	flash	0.5	Ramp Function High Level (normalized), applies to Current setpoint.
funcRampRisePrd	flash	10	Ramp Function Rise Period in milliseconds
funcRampFallPrd	flash	10	Ramp Function Fall Period in milliseconds
setSource	flash	0	Select Setpoint Source from Local, Function, or External Ctrl
sampleMode	EEPROM	factory determined	Change sampling mode on communication bus. 0 returns filtered samples, 1 return unfiltered values
senseMode	EEPROM	factory determined	Voltage terminals measurements sourced from local sense (0), remote sense (1), or leadless sense(2)
lockMode	EEPROM	factory determined	Behavior of unit when lock button is pressed
name	EEPROM	factory determined	User assigned name for unit
tapSetting	EEPROM	factory determined	Amount of digital filtering for voltage and current. Restricted between 0 (no filtering-fast) to 30 (full filtering-slow).
ctrlModeAux-Pwr	EEPROM	factory determined	Control modes for auxiliary power supply
protocol	EEPROM	factory determined	Select protocol for communications between product and computer.
sysMode	EEPROM	factory determined	System Mode, Configuration in which system of units are connected (standalone:0, parallel:1, series:2)
productModel-Num	EEPROM	factory determined	Product model number (e.g., ARx7.5-1000-15)
productType	EEPROM	factory determined	Product type (e.g., ARx, ALx, WRx)

continues on next page

Table 4.2 – continued from previous page

Name	Memory Type	Restore Value	Description
numFans	eeeprom	factory determined	Number of fans installed in the unit
frontPanelAddr	eeeprom	factory determined	Front panel target address (MagnaLINK)
frontPanelSeriesNum	eeeprom	factory determined	Front panel series number
frontPanelSerialNum	eeeprom	factory determined	Front panel serial number, zero if C-Panel
ratedVoltTarget	eeeprom	factory determined	Maximum voltage (V) target is specified to operate at
ratedCurrTarget	eeeprom	factory determined	Maximum current (A) target is specified to operate at
ratedResTarget	eeeprom	factory determined	Maximum resistance (Ohm) target is specified to operate at
ratedPwrTarget	eeeprom	factory determined	Maximum power (W) target is specified to operate at
ratedInputVoltTarget	eeeprom	factory determined	Maximum line-to-line input voltage (Vrms) product is specified to operate at
ratedInputCurrTarget	eeeprom	factory determined	Maximum input current (Arms) product is specified to operate at
ratedInputVoltTrip	eeeprom	factory determined	Input voltage phase loss trip constant
ratedTempTrip	eeeprom	factory determined	Thermal trips for all channels normalized between -95°C (0) to +95°C (1), zero indicates thermistor in absent. Refer to schematic in 1165-02-002 for channel allocation based on product type.
ratedRamp	eeeprom	factory determined	[Maximum Voltage Slew Rate; Maximum Current Slew Rate; Maximum Power Slew Rate; Maximum Resistance Slew Rate]
ratedVTermSensor	eeeprom	factory determined	Rating for the terminal voltage sensor (V)
ratedITermSensor	eeeprom	factory determined	Rating for the terminal current sensor (A)
ratedVDcLinkSensor	eeeprom	factory determined	Rating for the dc link voltage sensor (V)
ratedILSensor	eeeprom	factory determined	Rating for the phase current sensors (A)
ratedCurrChopper	eeeprom	factory determined	Rating for the phase current (A) at rated power
nChopperPhase	eeeprom	factory determined	Number of chopper modules
nLinePhase	eeeprom	factory determined	Number of AC input phases from the utility
chopperPrd	eeeprom	factory determined	Chopper Frequency Period in terms of number of Clock Cycles, defaults to 9.6 kHz
chopperClkDiv	eeeprom	factory determined	Chopper Frequency Clock Scaler Divisor
inverterPrd	eeeprom	factory determined	Inverter Frequency Period in terms of number of Clock Cycles, defaults to 600 Hz

continues on next page

Table 4.2 – continued from previous page

Name	Memory Type	Restore Value	Description
inverterClkDiv	eeeprom	factory determined	Inverter Frequency Clock Scaler Divisor
gainP1AutoX	eeeprom	factory determined	Autocrossover compensator proportional gain1
gainI1AutoX	eeeprom	factory determined	Autocrossover compensator integral gain1
gainP2AutoX	eeeprom	factory determined	Autocrossover compensator proportional gain2
gainI2AutoX	eeeprom	factory determined	Autocrossover compensator integral gain2
gainPMode-Chopper	eeeprom	factory determined	Chopper compensator proportional gain
gainIMode-Chopper	eeeprom	factory determined	Chopper compensator integral gain
gainDMode-Chopper	eeeprom	factory determined	Chopper compensator derivative gain
gainPModeIPV	eeeprom	factory determined	IPV compensator proportional gain
gainIModeIPV	eeeprom	factory determined	IPV compensator integral gain
gainPModeVPI	eeeprom	factory determined	VPI compensator proportional gain
gainIModeVPI	eeeprom	factory determined	VPI compensator integral gain
gainPModeR-PIV	eeeprom	factory determined	RPIV compensator proportional gain
gainIModeRPIV	eeeprom	factory determined	RPIV compensator integral gain
gainPModePIV	eeeprom	factory determined	PIV compensator proportional gain
gainIModePIV	eeeprom	factory determined	PIV compensator integral gain
gainPModeShuntReg	eeeprom	factory determined	Shunt regulator compensator proportional gain1
gainI-ModeShuntReg	eeeprom	factory determined	Shunt regulator compensator integral gain1
gainBModeShuntReg	eeeprom	factory determined	Shunt regulator compensator band
gainCalibrate	eeeprom	factory determined	[Voltage Gain; Current Gain; Remote Sense Voltage Gain; Phase Current Gain]
gainCalibrateCtrl	eeeprom	factory determined	[Set-point PWM Gain; Capture PWM Gain; available; available; available]
offset0	eeeprom	factory determined	Protection sensor offset
offset1	eeeprom	factory determined	Terminal voltage sensor offset
offset2	eeeprom	factory determined	Terminal remote voltage sensor offset
offset3	eeeprom	factory determined	Terminal current sensor offset

continues on next page

Table 4.2 – continued from previous page

Name	Memory Type	Restore Value	Description
offset4	eeeprom	factory determined	Phase current 1 sensor offset
offset5	eeeprom	factory determined	Phase current 2 sensor offset
offset6	eeeprom	factory determined	Phase current 3 sensor offset
offset7	eeeprom	factory determined	Linear module temperature sensor offset
offset8	eeeprom	factory determined	Resistor module 1 temperature sensor offset
offset9	eeeprom	factory determined	Resistor module 2 temperature sensor offset
offset10	eeeprom	factory determined	External analog set point
offset11	eeeprom	factory determined	Internal ADC offset Main Control
offset12	eeeprom	factory determined	Internal ADC offset Gate Drive
offset13	eeeprom	factory determined	Internal ADC offset Auxiliary Power
offset14	eeeprom	factory determined	Control PWM offset
availAddrLocal	eeeprom	factory determined	Address of devices on local network (port A)
commOption	eeeprom	factory determined	Communication daughter board type
ratedVoltProduct	eeeprom	factory determined	Maximum voltage (V) product is specified to operate at
ratedCurrProduct	eeeprom	factory determined	Maximum current (A) product is specified to operate at
ratedResProduct	eeeprom	factory determined	Maximum resistance (Ohm) product is specified to operate at
ratedPowerProduct	eeeprom	factory determined	Maximum power (W) product is specified to operate at
ratedVoltSystem	eeeprom	factory determined	Maximum voltage (V) system is specified to operate at
ratedCurrSystem	eeeprom	factory determined	Maximum current (A) system is specified to operate at
ratedResSystem	eeeprom	factory determined	Maximum resistance (Ohm) system is specified to operate at
ratedPowerSystem	eeeprom	factory determined	Maximum power (W) System is specified to operate at
magnaRouter	eeeprom	factory determined	Enable MagnaLINK Interface Device
enPortSerialCheck	eeeprom	factory determined	Set to enable serialized messages on any port
factoryValueSet	eeeprom	factory determined	Set to EEPROM to factory calibration mode (disk zero)
factoryRestoreMode	eeeprom	factory determined	Restore factory defaults to current disk

continues on next page

Table 4.2 – continued from previous page

Name	Memory Type	Restore Value	Description
optionRegister	eeeprom	factory determined	Integrated Options available on a product
deratedVolt-ProdFactor	eeeprom	factory determined	Derated voltage product is limited to operate at
deratedCurrProdFactor	eeeprom	factory determined	Derated current product is limited to operate at
deratedResProdFactor	eeeprom	factory determined	Derated resistance product is limited to operate at
deratedPower-ProdFactor	eeeprom	factory determined	Derated power product is limited to operate at
productConfig	eeeprom	factory determined	Product Configuration (e.g., A1, B1, C1)
featureRegister	eeeprom	factory determined	Features available on a product
statusRegister0Mask	eeeprom	factory determined	Mask status fault bits. See EnumStatusRegister for more information.
statusRegister1Mask	eeeprom	factory determined	Mask status fault bits. See EnumStatusRegister for more information.
funcPeriodMin	eeeprom	factory determined	Minimum Function Period in milliseconds
funcPeriodMax	eeeprom	factory determined	Maximum Function Period in milliseconds
sequenceId	eeeprom	factory determined	Sequence Identification
cmdStartAddr	eeeprom	factory determined	Storage location of sequence commands
cmdLength	eeeprom	factory determined	Length of commands programmed
paramStartAddr	eeeprom	factory determined	Storage location of sequence parameters
paramLength	eeeprom	factory determined	Length of parameters programmed

MAGNALINK

MagnaLINK™ is a low-level high-speed communication protocol designed by Magna-Power Electronics to expand functionality in the presence of multiple products, support real-time control, and handle multi-processor firmware upgrades.

5.1 Network Overview

There are three types of communications that the main control processor manages using three independent ports. On *Port A* the processor manages internal processor-to-processor traffic. Connected to this bus is the gate drive processor, which is responsible for power controls and protection. Also connected are the auxiliary power supply processors, which power all other boards, cooling fans, and solenoids. These processors are critical to the operation of the MagnaDC power supply; hence, communications on *Port A* bus are not exposed. *Port B* carries product-to-product and the front display processor traffic. The port is exposed through two RJ11 connectors located in the back of the product. Connections to the front display are made internally to the product. *Port B* is designed to handle more network nodes and has programmable termination resistors to dampen transmission-line effects. When connecting two products use only the Magna-Power Electronics supplied MagnaLINK™ cables. Front display boards are also connected to *Port B* to support remote-panel operation. *Port C* connects to external devices such as computers. The port defaults to *SCPI* protocol on start. Magna-Power Electronics software switches the protocol to MagnaLINK™ which contains the full set of commands available to MagnaDC power supply, is lower overhead, and faster speed.

5.2 Master-Slave Module Operation

When MagnaDC power supplies leaves the factory they are programmed with a fixed voltage, current, and power rating corresponding to the model. When multiple MagnaLINK™ compatible products are connected together, new ratings must be programmed for higher-power operation. If the detected power rating does not match the programmed power rating the product enters into a hard-fault condition. This rating check was added so that if any of the modules in the MagnaLINK™ chain are disconnected or fail, the customer can be notified, and take corrective actions. The instructions that follow explain how to wire slaves modules. The process for removing slave modules is identical to adding slave modules.

All MagnaDC power supplies need to be powered off by moving all front rocker switches into the off position. One MagnaDC power supply will be designated as a *master* all other MagnaDC power supplies will be *slaves*. On the *master*, connect the supplied MagnaLINK™ cable from the RJ11 connector labeled *MAGNALINK OUT* to the slave connector labeled *MAGNALINK IN*. Connect the red and black *Molex 1545* terminated cable from the MagnaLINK cable kit into the white, *Molex 1545 Series* plug, labeled *CURRENT SENSE*, in the back of the master and the slave units. After all the described connections have been made, turn on the rocker switches. Instructions for programming new ratings using are discussed in *MagnaCTRL*.

OPERATION: FRONT PANEL

6.1 Operation: Front Panel

The standard MagnaDC power supply front panel provides local control and display of the product's various parameters and settings. Fig. 6.1 provides an overview of the standard 1U MagnaDC power supply front panel and Fig. 6.2 provides an overview of the blank (+BP) MagnaLOAD front panel. A numbered list corresponding to the indicators on the front panels is located below the front panel figures.

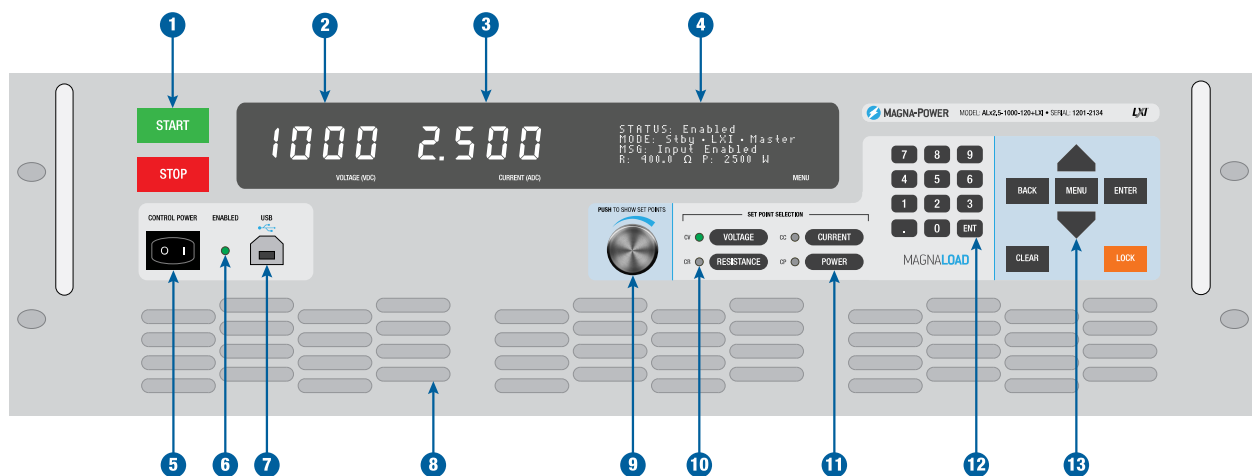

Fig. 6.1: Standard MagnaDC power supply front panel overview



Fig. 6.2: Blank MagnaDC power supply front panel overview

1. Start Button: Enables the DC output bus
Stop Button: Disables the DC output bus
2. Voltage measurement display
3. Current measurement display
4. 4-line character display featuring a menu system, operating status and modes, product messages with diagnostic codes, and power measurement display
5. Control power switch, energizes the control circuits without engaging DC bus
6. LED indicator that the DC output is enabled
7. Full control (host) front panel USB port
8. Clean air intake, with integrated fans
9. Aluminium digital encoder knob for programming set-points
10. LED indicator of the MagnaDC power supply's present regulation state, which can include: constant voltage (CV), constant current (CC), or constant power (CP)
11. Selector buttons to choose which set-point the digital encoder knob and digital keypad buttons will modify.
12. Menu Button: Enters the menu system on the 4-line display
Back Button: Moves back one level in the menu
Enter Button: Selects the highlighted menu item
Clear Button: Removes the product from a faulted state
Lock Button: Locks the front panel, with password protection available

6.1.1 Set Point Adjustment

The MagnaDC power supply's set points define the regulation limits. To view the programmed set points, press and release the black digital encoder knob. The set points that can be programmed are in bold, while the unavailable set points are muted. The available set points will vary depending on the configured *control mode*.

The illuminated Voltage, Current, Resistance and Power set point buttons on the front panel correlate to the set point that will be adjusted by the user's input. Pushing one of these set point buttons will change set point to be adjusted, if that set point is available within the selected control mode.

There are three methods of adjusting the set point from the front panel: digital encoder knob, keypad, and arrow keys.

The black aluminum **digital encoder knob** increases the set point when turned clockwise and decreases the set point when turned counterclockwise. Turning the knob faster will increase the set point adjustment rate. The selected set point is adjusted on-the-fly when the knob is turned, whether viewing the output measurements or whether viewing the set points.

The **12-digit keypad** allows a specific number to be entered in. The number entered will not take effect until either the Enter (ENT) button is pressed. Pressing a number will automatically change the display to view all set points.

When pressed once and released, the **arrow-up and arrow-down** buttons adjust the set point by the lowest available bit. By pressing and holding these button, a larger set point adjustments will be made. The selected set point is adjusted on-the-fly when the arrow key is pressed, whether viewing the output measurements or whether viewing the set points.

Set Point Source

Set points that control the SLx Series can come from by multiple sources. *Set Point Source* selects set points from these sources and routes them as inputs into the digital controller. When a particular source is selected, set points from all other sources are ignored.

By default, the source is set to *local*, where set points originate from the front panel keypad, knob, or communication interfaces. When the source is set to *function generator*, current set point is generated internally, by a periodic function generator block, whose value are defined according to the parameters in *Function Generator*. When *external analog input* is selected, the voltage applied to the rear connector, as described in *Analog Inputs*, are converted into set points.

6.1.2 Auxiliary Display

The MagnaDC power supply's standard front panel features an auxiliary 4-line character display used for two distinct views: the product's *operating status* and a multi-level *menu system*, used for configuring various products settings.

Operating Status Display

The default display on the auxiliary display provides information about the MagnaDC power supply's present operating conditions, as follows:

Status The product's present operating *status*.

Mode The product's presently selected *control mode* and active *computer programming interface*.

Message (MSG) A detailed description of the product's present status including steps listed to resolve a fault.

Power (P) The measured power being dissipated in the MagnaDC power supply through its DC input terminals.

Menu System

A multi-level menu system is provided on the standard front panel to configure the product's various settable parameters. The buttons on the right-hand side of the front panel control navigation through the menu system, with functions as follows:

Menu Button Transitions the auxiliary display from the *operating status* to the menu system.

Back Button Moves up one level in the menu system. While at the top level of the menu system, the Back Button will return to the *operating status* display.

Up Arrow Button / Down Arrow Button While browsing through the menu system the Up Arrow Button and Down Arrow Button moves item selector up and down, respectively. While keying in a new numeric value for a parameter, the Up Arrow Button and Down Arrow Button increments and decrements the parameter's setting by the lowest available bit. After increment or decrementing the value, the Enter Button must be pressed to save the value.

Enter Button While browsing through the menu system, the Enter Button selects the highlighted menu item and transitions to the next level beneath the selected menu item. While browsing a list of settable parameters, pressing the Enter Button will select the highlighted parameter allowing you change its value. While keying in a new numeric value for that parameter, such a set point, pressing the Enter Button will set that new value.

Clear Button While browsing through the menu system or through a list of parameters, the Clear Button will exit out of the menu system and return to the *operating status* display. While keying in a new numeric value for a parameter, the Clear Button will zero that parameter's value; the Enter Button must then be pressed to set that zero value.

6.2 Menu System Listing

- Trip-Point Settings
 - OVT - Sets the over voltage trip set-point
 - OCT - Sets the over current trip set-point
 - OPT - Sets the over power trip set-point
 - UVT - Sets the under voltage trip set-point
- Control Mode
 - Standby
 - Auto Crossover
 - CalLoad1
 - CalLoad2
- Function Generator
 - Function Type
 - * Sinusoid
 - * Square
 - * Step
 - * Ramp
 - Function Parameter
 - * Sinusoid Parameters
 - Amplitude
 - Offset
 - Period
 - * Square Parameters
 - LoLevel
 - HiLevel
 - LoPeriod
 - HiPeriod
 - * Step Parameters
 - LoLevel
 - HiLevel
 - * Ramp Parameters
 - LoLevel
 - HiLevel
 - RiseTime
 - FallTime

- Automatic Sequence
 - Sequence 1
 - Sequence 2
 - Sequence 3
 - Sequence 4
- Communication Setting
 - RS485
 - * RS485 Information
 - Command Protocol
 - * SCPI
 - * MagnaLINK
 - * Modbus
 - * Anybus
 - Ethernet Settings
 - * MAC Address
- MagnaLINK Settings
 - Master Slave Mode
 - * Standalone
 - * Parallel
 - * Series
 - Re-initialize Slaves
 - * Cancel
 - * Re-initialize
- Performance Settings
 - Slew Rates
 - * Rise - Voltage Slew (V/ms)
 - * Fall - Voltage Slew (V/ms)
 - * Rise - Current Slew (A/ms)
 - * Fall - Current Slew (A/ms)
 - * Rise - Power Slew (W/ms)
 - * Fall - Power Slew (W/ms)
 - Remote Sense Mode
 - * Local
 - * Remote
- System Settings
 - Setpoint Source

- * Front Panel
- * Function Generator
- * Analog Input
- * Sequence Input
- Analog Digital IO
 - * Analog Input Pins
 - Pin 5
 - Pin 17
 - Pin 18
 - * H/S Analog Input Pin
 - Pin 6
 - * Analog Output Pins
 - Pin 3
 - Pin 4
 - Pin 15
 - Pin 16
 - * Digital Input Pins
 - Pin 11
 - Pin 12
 - Pin 23
 - Pin 24
 - * Digital Output Pins
 - Pin 7
 - Pin 8
 - Pin 9
 - Pin 10
 - Pin 19
 - Pin 20
 - Pin 21
 - Pin 22
- Fan Speed
 - * Variable
 - * Max
 - * Off
- Factory Restore
 - * Cancel

- * Soft Restore
- * Hard Restore
- Integrated Options
 - * optionRegister
 - * readOnly
- About
 - Unit Description
 - Sys Power (kW)
 - Sys Volt (V)
 - Sys Curr (A)
 - Serial
 - Address
 - Firmware Vers
 - Bootloader Vers
 - Hardware Vers
 - Internal Slaves
 - External Slaves

OPERATION: EXTERNAL USER I/O

The analog-digital inputs and outputs for the External User I/O port are reconfigurable, allowing the pins to be assigned according to the application and desired parameters. Therefore, the External User I/O pins are grouped according to function, with numerous selectable parameters in the following groupings: *Analog Inputs*, *Analog Outputs*, *Digital Inputs*, and *Digital Outputs*. Refer to each of these sections for the various parameters that can be assigned to the External User I/O pins.

Note: Not all pins need to be set

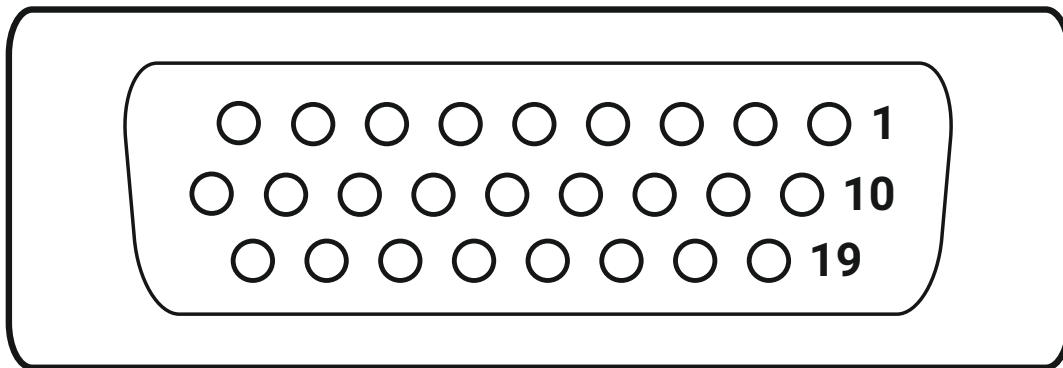

Fig. 7.1: External User I/O D-Sub 26-pin Connector and Pin Layout

The following table provides the External User I/O pin layout:

User I/O Pin	Designation	Description
1	GND ANALOG	Ground (Analog Reference)
2	+10V REF	10V Reference Voltage, 20 mA max
14	+5V	5V Reference Voltage, 20 mA max
25	GND	Ground
5	AI0	<i>Analog Input</i>
6	AI1	<i>Analog Input (High Speed)</i>
17	AI2	<i>Analog Input</i>
18	AI3	<i>Analog Input</i>
3	AO0	<i>Analog Output</i>
4	AO1	<i>Analog Output</i>
15	AO2	<i>Analog Output</i>
16	AO3	<i>Analog Output</i>
11	DI0	<i>Digital Input</i>
12	DI1	<i>Digital Input</i>
23	DI2	<i>Digital Input</i>
24	DI3	<i>Digital Input</i>
7	DO0	<i>Digital Output</i>
8	DO1	<i>Digital Output</i>
9	DO2	<i>Digital Output</i>
10	DO3	<i>Digital Output</i>
19	DO4	<i>Digital Output</i>
20	DO5	<i>Digital Output</i>
21	DO6	<i>Digital Output</i>
22	DO7	<i>Digital Output</i>
13	E-STOP	Emergency Shutoff (+) (MagnaDC Only)
26	E-STOP Return	Emergency Shutoff (-) (MagnaDC Only)

7.1 Analog Inputs

The SLx Series MagnaDC power supply has four analog inputs on its rear External User I/O 26-pin port. The External User I/O pin layout is defined in *Operation: External User I/O*.

The four analog inputs (Pins 5, 6, 17, 18) can be configured to select different trip or set point values. For the inputs to take effect, *Analog Input* must be selected in the *Set Point Source* menu. By factory default, the analog input is disabled. If the source is selected, and one leaves the pin floating, the signal is pulled down resulting in a zero set point.

Standard analog inputs (Pins 5, 17, 18) are used for applications requiring high stability. Inputs are sampled and digitally filtered heavily to remove measurement noise and produce a stable input signals. High-speed analog input (Pin 6) is used for applications requiring fast changes. Here, the input is not filtered and updates every 500 μ s.

The following table provides the selection of the available analog input parameters:

Parameter	Description	Input Reference Voltage Range	Corresponding Output Range	Default Pin
Vset	Voltage Set Point	0-10V	0-100% of maximum rated voltage	None
Iset	Current Set Point	0-10V	0-100% of maximum rated current	Pin 5
Pset	Power Set Point	0-10V	0-100% of maximum rated power	None
OVT	Voltage Trip Point Setting	0-10V	10%-110% of maximum rated voltage	None
OCT	Current Trip Point Setting	0-10V	10%-110% of maximum rated current	None
OPT	Power Trip Point Setting	0-10V	10%-110% of maximum rated power	None

A 0-10V input on the Voltage, Current, and Power Set Point input parameters corresponds to a proportional setting of 0-100% of product's maximum rated voltage, current, and power, respectively. As trip point settings are available up to 110% of the MagnaDC power supply's maximum ratings, a 10V input on these trip points settings will correspond to 110% of the unit's maximum rating.

Note: Applying the same voltage reference to a set point input and its corresponding trip point setting is a common way to minimize the number of connections necessary from controlling hardware. With the same voltage reference on the two corresponding inputs, the product will be provided with a set point and then a trip setting 10% above that value. For example, applying the same +5V reference signal for both Vset and OVT on a product rated for 500 Vdc maximum, will correspond to a Voltage Set Point of 250 Vdc and a OVT setting of 275 Vdc.

If an analog input signal is enabled on the External User I/O, a voltage reference **must** be provided on the selected pin for that parameter. With the input signal enabled, the MagnaDC power supply will no longer reference the digitally stored values for that parameter, meaning no other programming method will be available for that parameter as long as it's assigned to an analog input. For example, if the user enables Iset on one of the analog input signals, Iset can no longer be programmed from the front panel or computer interface; instead, the user needs to provide a 0-10 V reference on the selected pin.

The analog reference ground is provided on Pin 1 of the External User I/O. As the MagnaDC power supply's power processing stages can develop electrical noise on the earth ground, this analog reference ground is provided as a clean reference control ground path allowing for accurate low-level voltage programming and measurement. The analog reference ground is tied to the product's earth ground through resistance, to help filter any noise on the ground.

The set points driven by the analog inputs are visible on the front panel set point menu and can also be queried from the computer interface. Similarly, the trip point settings driven by the analog inputs are visible on the front panel trip point sub-menu and can be queried from the computer interface.

7.2 Analog Outputs

The following table provides the selection of the available analog output parameters:

Parameter	Description	Output Reference Range	Reference Voltage	Corresponding Output Range	Default Pin
Vterm	Measured Voltage	0-10V		0-100% of maximum voltage	Pin 4
Iterm	Measured Current	0-10V		0-100% of maximum current	Pin 3
Pterm	Measured Power	0-10V		0-100% of maximum power	None

The voltage, current, and power measurements provided by the analog outputs are measured at the configured sense location. If remote sense is enabled, the measurement will be taken at the sense leads; otherwise, the measurement will be taken at locally at the DC terminals.

7.3 Digital Inputs

The SLx Series MagnaDC power supply has four digital input signals on its rear External User I/O. The External User I/O pin layout is defined in *Operation: External User I/O*.

The four digital inputs are reconfigurable, allowing the user to change the pin assignments. The pin assignment can be modified from the front panel or from the MagnaWEB software.

Each digital input function is activated using +5V logic, but the logic varies among the available functions. This logic used by each function is detailed in the table below.

The digital input impedance is 10 kΩ.

A +5V reference signal is provided on Pin 14. This reference signal may be used in conjunction with external dry contacts to trigger the digital input functions.

Note: For safety, the Stop function will always take precedence over the Start function.

The following table provides the selection of the available digital input parameters:

Command/Function	Description	Default Pin	Logic
Enable	Enabled the power processing circuitry	Pin 11	Active When Present
<i>Interlock</i>	Normal operation requires a +5V assertion signal.	None	Normally Closed
<i>Clear Fault</i>	Removes fault status if the fault condition is no longer present.	Pin 12	Momentary
<i>Lock</i>	Block inputs from front panel keypresses.	None	Active When Present

7.3.1 Digital Input Logic Definitions

Momentary The function is triggered by the momentary rising edge of a +5V signal. The minimum pulse duration to activate a momentary digital input function is 3 ms.

Normally Closed When the function has been assigned to a pin, +5V must be present on the designated pin for normal operation. When the +5V is removed, the function will be triggered.

Active When Present The function is active as long as +5V is present on the designated pin.

7.4 Digital Outputs

The SLx Series MagnaDC power supply has eight digital output signals on its rear External User I/O. The External User I/O pin layout is defined in *Operation: External User I/O*.

The eight digital outputs are reconfigurable, allowing the user to change their pin assignments. The pin assignment can be modified from the front panel.

The digital outputs are used to monitor the MagnaDC power supply's internal states. A pin will output +5V when a state is active and 0V when a state is inactive. The maximum output current per pin is 20mA.

Caution: Trying to draw more than 32 mA from a digital output will damage the MagnaDC power supply's controller.

The following table provides the selection of the available digital output parameters:

State	Description	Default Assignment
Enabled	The input is engaged and the MagnaDC power supply is processing power	Pin 7
Standby/Fault	The MagnaDC power supply is either in a standby or faulted state	None
Standby	The MagnaDC power supply is in standby	Pin 8
Fault	The MagnaDC power supply is in a faulted state	Pin 9
CV Regulation	The MagnaDC power supply is regulating voltage	None
CC Regulation	The MagnaDC power supply is regulating current	None
CP Regulation	The MagnaDC power supply is regulating power	None
CR Regulation	The MagnaDC power supply is regulating resistance	None
Lock	The lock function is active and the MagnaDC power supply is locked	None

OPERATION: COMPUTER PROGRAMMING

8.1 Operation: Computer Programming

Every MagnaDC power supply has the following communication connections available:

Interface	Location	Connector	Standard/Optional	Priority
USB (Host)	Front	JR1	Standard	1
USB (Host)	Rear	JR2	Standard	2
RS485	Rear	JR3	Standard	5
LXI TCP/IP Ethernet	Rear	JR6	Optional	3
IEEE-488 GPIB	Rear	JR6	Optional	3

All of the communication connections share the same internal communications bus; only one communication interface can be used at a time. The front panel menu display will always show what communication interface is active. The MagnaDC power supply

The front panel USB takes the highest computer interface priority. When a front or rear USB connection is physically made the MagnaDC power supply will automatically switch to computer control from RS485 to the newly connected USB port. Conversely, when a command is sent via the optional LXI TCP/IP Ethernet or IEEE-488 GPIB interface, the MagnaDC power supply will automatically switch to computer control from the Ethernet or GPIB port with the new communication. Switching back to USB requires disconnecting and reconnecting the USB plug or power cycling the MagnaDC power supply. RS485 is the lowest priority interface and only has control when the USB ports are disconnected and there is no communication over LXI TCP/IP Ethernet or IEEE-488 GPIB interfaces.

8.1.1 Communications Validation

It is important to establish and validate basic communications functions before starting a sophisticated computer interface project. The following instructions are intended to help customers isolate problems with computer settings, wiring, and electrical noise. The validation instructions also provide a common environment for which Magna-Power can reproduce issues in support cases and better serve the customer.

If not already installed, Magna-Power Electronics recommends using the terminal emulation programs called [PuTTY](#) for creating serial connections.

USB Communications Validation

USB uses serial communications. To test, make a physical connection between the USB Type B connector on the MagnaDC power supply and the USB Type A on the computer. Pin outs for these connectors are described in [USB Interface](#). Connect using the standard USB cable included with the product. The front panel shows the active state of the communications interface. If the front USB was connected, the display should transition from RS485 to USB2. If the rear USB was connected, the display should transition from RS485 to USB1. After a physically connection is made a session connection is made with the MagnaDC power supply.

Open *Device Manager* and under ports make note of the COM port number, as shown in [Fig. 8.1](#).

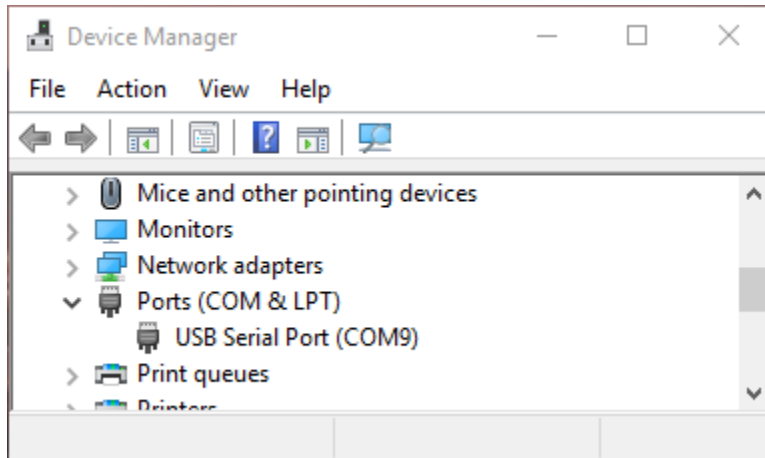

Fig. 8.1: Window Device Manager

Open *PuTTY* and select the *Session* menu. Enter the COM port that was found in *Device Manager* and enter 115200 for the *Speed*. Set the *Connection type* to *Serial*, as shown in [Fig. 8.2](#).

Select the *Terminal* menu and set *Force on* for all options. Press the *Open* button to start the communications session with the MagnaDC power supply, as shown in [Fig. 8.3](#).

Session should open a new blank window. Type the command:

```
*IDN?
```

If settings match and wiring connections are correct, the session window should look like [Fig. 8.4](#).

RS485 Communications Validation

RS485 also uses serial communications. Most customers will need a USB-to-RS485 adapter (not included) to allow the computer to connect to RS485. Any RS485 adapter should work provided it supports half-duplex communication and 115200 baud. Magna-Power Electronics recommends USB-COM485-PLUS1 and USB-COM485-PLUS4 adapters from FTDI. The adapter will serial port(s) in Windows *Device Manager*.

Customers will also need to create their own cable. The MagnaDC power supply interfaces to RS485 through a RJ45 connector located in the rear. RJ45 mates readily with Category 5 Ethernet cables. When crimping wires to the connector make sure to follow the pins outs described in [RS485 Interface](#).

By default, the RS485 interface is active when no other communication interface cables are connected. The front display will always show the RS485 state even when the wire is disconnect. Once the computer and MagnaDC power supply are physically connected, open PuTTY, and follow the instructions described in [USB Communications Validation](#) to make a serial connection and test it.

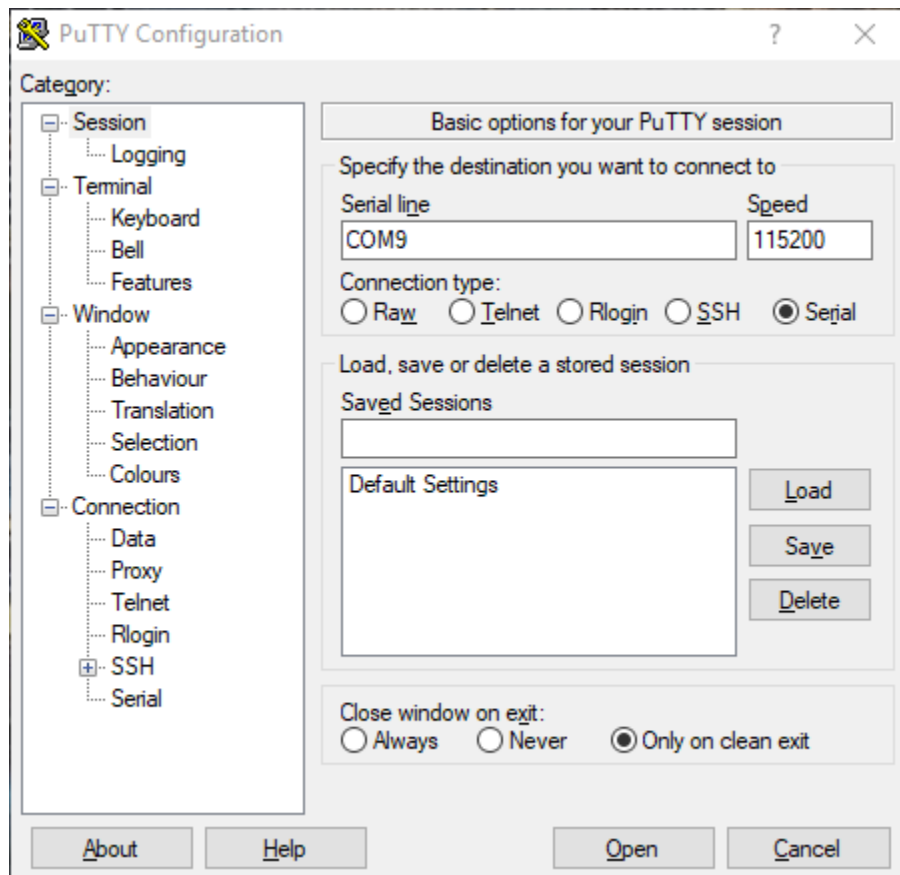

Fig. 8.2: PuTTY Session Settings

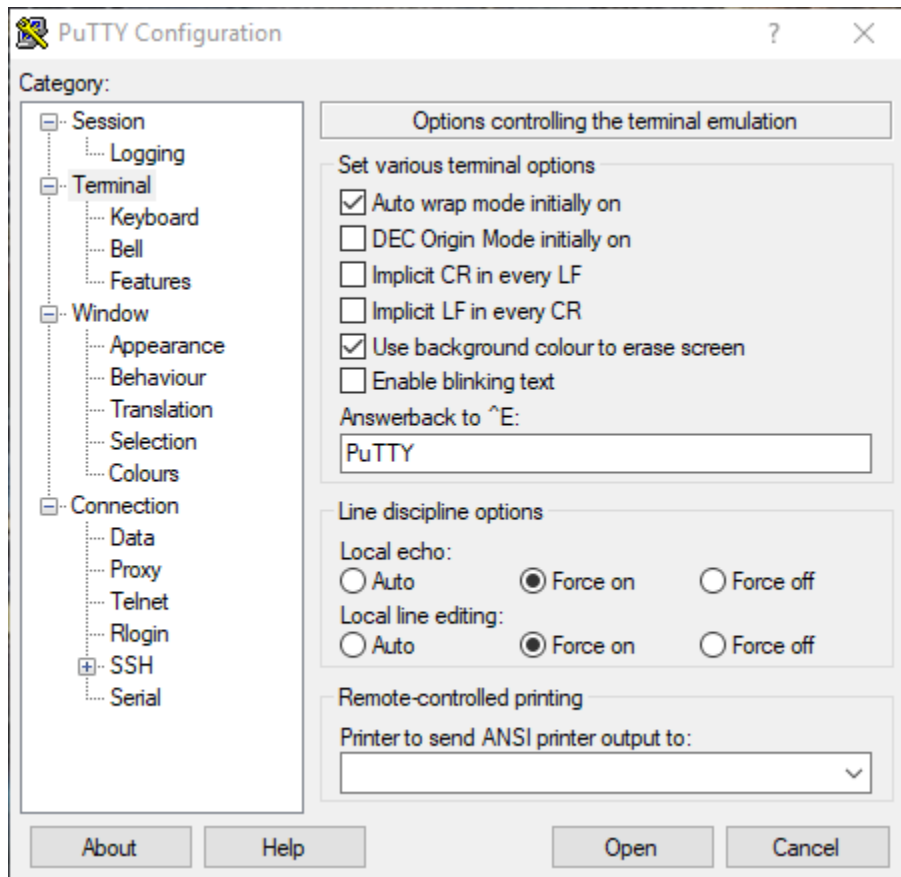

Fig. 8.3: PuTTY Terminal Settings

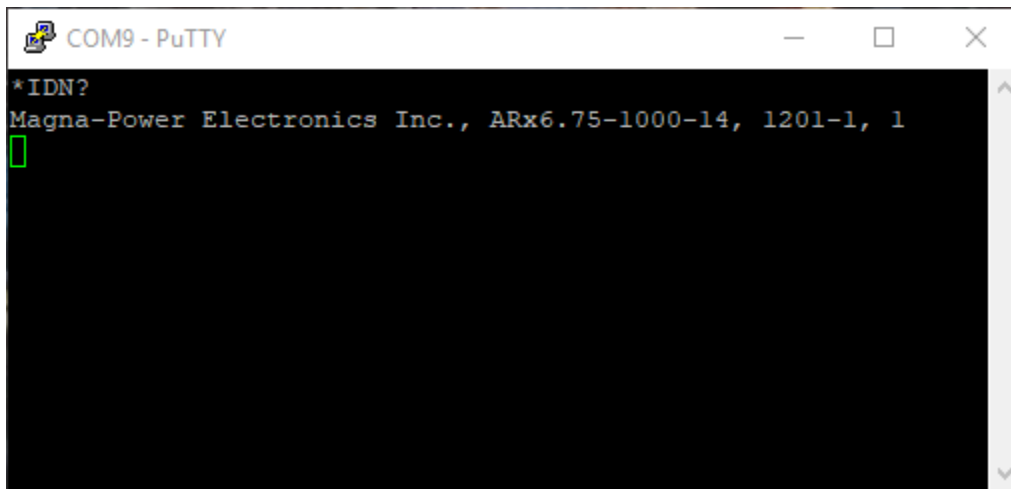

Fig. 8.4: PuTTY Terminal Session Output

8.2 Programming Methods

There is a large selection of commands and interfaces that can be used to program the MagnaDC power supply. A computer can communicate with MagnaDC power supply using either USB, RS485, Ethernet, or GPIB. A programmable logic controller can control MagnaDC power supply operation through analog IO and digital IO pins exposed on the rear connector.

The MagnaDC power supply implements Standard Commands for Programmable Instrumentation (SCPI), a protocol that communicates using simple ASCII commands through a standard serial port. These commands are detailed in *SCPI Command Set*. Simple digital and analog interfaces to the product are detailed in *Operation: External User I/O*.

8.3 USB Communications

Two USB ports come standard on all MagnaDC power supplies. Magna-Power Electronics implements the USB protocol stack using FTDI chip set, a plug and play (PnP) device, that automatically install drivers. Connection to a computer can be established using a standard USB cable, with one end connected to the MagnaDC power supply and the other to a controlling device. The communication port parameters are shown in [Table 8.1](#). Guidelines on establishing simple serial session is discussed in *USB Communications Validation*.

Table 8.1: Serial Port Settings

Parameter	Value
Baud	115200
Data bits	8
Stop bits	1
Parity	None
Flow Control	None

8.4 RS485 Communications

One RS485 port comes standard on all MagnaDC power supplies. Connection to a computer can be established using a modified Ethernet cable (not included), with one end connected to the MagnaDC power supply and the other to a controlling device. The communication port parameters are shown in [Table 8.1](#).

8.5 LXI TCP/IP Ethernet Communications

MagnaDC power supply products are available with an optional LXI TCP/IP Ethernet interface (+LXI). The LXI TCP/IP Ethernet interface meets the LXI Class C, Revision 1.4 standard. When specified at time of order, an Ethernet interface module is installed, providing an embedded Ethernet port for communications.

Ethernet connections can be made Magna-Power supplied software interface application, terminal emulation programs like PuTTY, user written software, National Instruments LabVIEW™ and a wide variety of other software programming interfaces.

8.5.1 Address Negotiation

By default, DHCP is enabled on the MagnaDC power supply. If the Ethernet board does not discover a DHCP server, the MagnaDC power supply will default to the Auto-IP configuration as defined in Table 8.2. The device then automatically selects an IP address from 169.254.###.### and subnet as described in RFC 3927 (Request for Comments 3927 - Dynamic Configuration of IPv4 Link-Local Addresses). This routine is used by most computer operating systems.

Table 8.2: Default LXI TCP/IP Ethernet Setting (without DHCP server)

IP Address	169.254.###.###
Subnet Mask	255.255.0.0
Default Gateway	0.0.0.0
DNS Server	0.0.0.0
MAC Address	01:1E:6F:##:##:##
Username	admin
Password	<i>leave blank</i>

The LAN Reset button provides a way to reset the LAN configuration password and to set the device back to DHCP/Auto-IP mode. To activate the LAN Reset function, ensure the power supply is on and in standby mode. Hold down the LAN Reset button for approximately 4 seconds. Observe that the LAN LED rapidly flashes and after 4 seconds, release the LAN Reset button. The LAN configuration password will be reset to blank and the module will be set to DHCP/Auto-IP enabled.

The MAC address consists of two number groups, in format: ##:##:##:##:##:##. For Magna-Power Electronics products, the first three bytes are always 01:1E:6F. The second three bytes are determined by the LXI TCP/IP Ethernet interface's serial number, converted to hex. This serial number can be queried from the power supply using the SCPI command `SYSTEM:COMMUNICATE:NETWORK:SERIAL`.

The LXI TCP/IP Ethernet module supports the mDNS discovery protocol allowing the device to be discovered on the network by software such as National Instruments Measurement and Automation Explorer, Agilent Connection Expert, or the Remote Interface Software supplied with the power supply.

8.5.2 Connectivity

The LAN status LED, located at the rear of the MagnaDC power supply, provides LAN fault and device identification, defined as follows:

On - Normal Operation The device has a properly configured IP address and the network cable is connected.

Flashing - Device Identify The LXI Device Identification function was enabled via the Instrument Identification web page. This identification can help the user to quickly locate the unit and distinguish it from similar devices.

Off - LAN Fault The device is experiencing one or more of the following LAN fault conditions: failure to acquire a valid IP address, detection of a duplicate IP address on the network, failure to renew an already acquired DHCP lease, or the LAN cable is disconnected.

8.5.3 Network discovery

The Ethernet module supports the mDNS discovery protocol allowing the device to be discovered on the network by software such as National Instruments' Measurement and Automation Explorer, Agilent Connection Expert, or the Remote Interface Software (RIS Panel) supplied with the MagnaDC power supply.

NI Measurement and Automation Explorer

To access discovery with NI Measurement and Automation Explorer, the NI-VISA add-on module must be installed along with the standard software package. Start NI Measurement and Automation Explorer, right-click on Devices and Interfaces, and then select "Create New..." Select "VISA TCP/IP Resource" from the list. Click Next and then select Auto-detect of LAN Instrument. Click Next and the software will scan the local network for VXI devices and display them for configuration for further usage with NI-VISA and related software.

Agilent Connection Expert

To access discovery with Agilent Connection Expert, start Agilent Connection Expert. Select your computer's LAN interface and then click the Add Instrument button at the top of the screen. The software will scan the local network for VXI devices and display them for configuration for further use with Agilent VISA compatible software.

Web Browser

The LXI TCP/IP Ethernet interface has an embedded web server that allows the user to view and change the module's network settings. Magna-Power Electronics LXI TCP/IP Ethernet interface is LXI Class C compliant under LXI Standard Revision 1.4.

To access the web server, first determine the module's IP address via as described in the *MagnaCTRL*. Alternatively, if the host computer supports NetBIOS over TCP/IP, you may use the device's NetBIOS name instead of the IP address.

Open a WC3 compliant web browser such as Google Chrome, Edge (Chromium), or Mozilla Firefox to [http:// \[ipaddress\]/](http://[ipaddress]/) or [http://\[hostname\]/](http://[hostname]/). The instrument information screen will be displayed as shown in *Web interface information panel*. This figure provides the basic information about the configuration and allows the user to enable or disable the LXI Identification. Click Enable Identify or Disable Identify to change the state of the LXI Identification. When LXI Identification is enabled, the LAN LED on the back of the MagnaDC power supply unit will blink. This can help the user to quickly locate the MagnaDC power supply and distinguish it from similar devices.

To change the Ethernet interface's network settings, click the Configure tab in the upper right. The browser will prompt for a username and password if you have not authenticated the device already. To authenticate, enter admin for the username and leave the password field blank. The instrument configuration screen, *Web interface configuration panel*, will appear. This page enables the user to change the Hostname (which corresponds to the NetBIOS name), the description, password, and TCP/IP configuration. After changes to the configuration are made, click the Save Config button. The configuration will be saved, the Ethernet interface will reboot and instructions will be displayed for reconnecting to the interface.

The browser may prompt for a username and password if you have not authenticated the device already. To authenticate, enter admin for the username and leave the password field blank.

MAGNA-POWER ELECTRONICS

INFORMATION CONFIGURE CONTROL MAGNA-POWER

INSTRUMENT INFORMATION

Instrument Model:	TSA125-120
Manufacturer:	Magna-Power Electronics Inc.
Serial Number:	00000000
Description:	MPE Power Supply
LXI Class:	Class C
LXI Version:	1.2
Hostname	192.168.1.241
MAC Address	00-1E-6F-00-00-00
TCP/IP Address:	192.168.1.241
Firmware Revision:	Firmware Rev. 7.3, Hardware Rev. 3.0
Instrument Address String:	TCPIP::192.168.1.241::50505::SOCKET
SCPI TCP Port:	50505
Netbios Name:	MPE00000000
Ethernet Module Revision:	Firmware Rev. 2.1, Hardware Rev. 2.0

LXI IDENTIFY:
[Enable Identify](#)
[Disable Identify](#)



Fig. 8.5: Web interface information panel

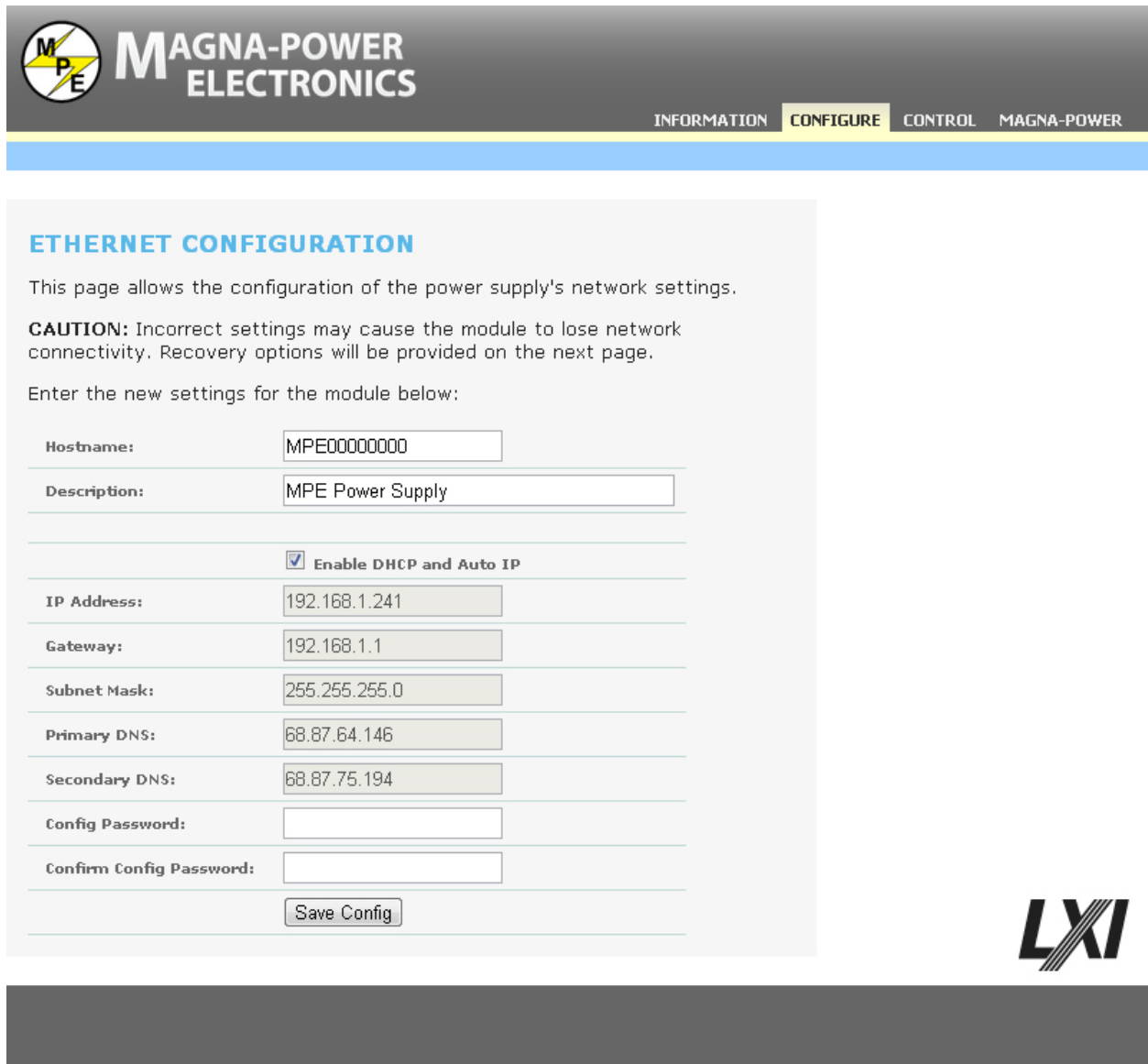

The screenshot shows the 'MAGNA-POWER ELECTRONICS' logo on the left and a navigation menu with 'INFORMATION', 'CONFIGURE', 'CONTROL', and 'MAGNA-POWER' on the right. The 'CONFIGURE' tab is active. Below the navigation bar is a blue header with the title 'ETHERNET CONFIGURATION'. The main content area contains a descriptive paragraph, a caution note, and a form for entering network settings. The form includes fields for Hostname, Description, IP Address, Gateway, Subnet Mask, Primary DNS, Secondary DNS, Config Password, and Confirm Config Password. A 'Save Config' button is located at the bottom of the form. The LXI logo is visible in the bottom right corner of the interface.

MAGNA-POWER ELECTRONICS

INFORMATION **CONFIGURE** CONTROL MAGNA-POWER

ETHERNET CONFIGURATION

This page allows the configuration of the power supply's network settings.

CAUTION: Incorrect settings may cause the module to lose network connectivity. Recovery options will be provided on the next page.

Enter the new settings for the module below:

Hostname:	<input type="text" value="MPE0000000"/>
Description:	<input type="text" value="MPE Power Supply"/>
	<input checked="" type="checkbox"/> Enable DHCP and Auto IP
IP Address:	<input type="text" value="192.168.1.241"/>
Gateway:	<input type="text" value="192.168.1.1"/>
Subnet Mask:	<input type="text" value="255.255.255.0"/>
Primary DNS:	<input type="text" value="68.87.64.146"/>
Secondary DNS:	<input type="text" value="68.87.75.194"/>
Config Password:	<input type="password"/>
Confirm Config Password:	<input type="password"/>
	<input type="button" value="Save Config"/>

LXI

Fig. 8.6: Web interface configuration panel

8.6 MagnaCTRL

MagnaCTRL is a software application created by Magna-Power to connect to the SLx Series MagnaDC power supply through RS485, USB, or LXI. There is a menu in the the program that will discovery other LXI devices on the network and connect to one of them.

SCPI COMMAND SET

9.1 SCPI Command Set

Standard Commands for Programmable Instrumentation (SCPI) support is provided for all MagnaDC power supply products. These commands provide programming compatibility with other instruments. SCPI commands are ASCII textual strings, which are sent to the instrument over the physical layer, providing support over all communication interfaces. Utilizing these SCPI commands provides the simplest form of programming a MagnaDC power supply product, as they are driver and programming environment independent. Further information about the SCPI standard and conventions are in the section: *SCPI Introduction*. The full list of linked commands are in section: *SCPI Commands*.

9.1.1 SCPI Introduction

Command Structure

There are two types of SCPI messages: program and response.

A *program message* consists of one or more properly formatted SCPI commands sent from the controller to the MagnaDC power supply. The message, which may be sent at any time, requests the MagnaDC power supply to perform some action.

A *response message* consists of data in a specific SCPI format sent from the MagnaDC power supply to the controller. The MagnaDC power supply sends the message only when requested from a program message query.

Data Types

The following datatypes, referenced in the SCPI command descriptions, describe the responses from query SCPI commands:

<NR1> Digits with an implied decimal point assumed at the right of the least-significant digit. Example: 273

<NR2> Digits with an explicit decimal point. Example: .0273

<NR3> Digits with an explicit decimal point and an exponent. Example: 2.73E+2

The following data types, referenced in the SCPI command descriptions, describe the parameters from program SCPI commands:

<Nrf> Extended format that includes **<NR1>**, **<NR2>**, and **<NR3>**. Examples: 273, 273., 2.73E2

<Nrf+> Expanded decimal format that includes **<Nrf>** and MIN MAX. MIN and MAX are the minimum and maximum limit values that are implicit in the range specification for the parameter. Examples: 273, 273., 2.73E2, MAX

<Bool> Boolean Data. Example: 0 | 1 or ON | OFF

Termination

A new line <NL> character must be sent to the MagnaDC power supply to terminate a SCPI command string. The IEEE-488 EOI (End-Or-Identify) message is interpreted as a <NL> character and can be used to terminate a command string in place of an <NL>. A carriage return followed by a new line <CR><NL> is also accepted. Command string termination will always reset the current SCPI command path to the root level.

Syntax Conventions

Square brackets [] Used to enclose a parameter that is optional when programming the command; that is, the instrument shall process the command to have the same effect whether the option node is omitted by the programmer or not.

Angle brackets <> Used to enclose mandatory parameters or to indicate a returned parameter. For example, in the CURRent <value> command syntax, the <value> parameter is enclosed in triangle brackets. The brackets are not sent with the command string. You must specify a value for the parameter, for example: CURRent 125

Vertical bar | Used to separate multiple parameter choices for the command string, for example: [SOURce:] CURRent 0 through MAX | MINimum | MAXimum

9.1.2 SCPI Commands

Reference List

The subsystems provide more details on all the supported commands. The following table provides a summary of all the available SCPI commands:

SCPI Command	Description
CONFigure Subsystem	
<i>CONFigure:CONTrol</i>	Sets the control mode
<i>CONFigure:LOCK</i>	Locks and unlocks the product from configuration and set-point changes
<i>CONFigure:REStore</i>	Restores the factory EEPROM data
<i>CONFigure:SENSe</i>	Configures the sense location and automated compensation values
<i>CONFigure:SOURce</i>	Sets the setpoint source
<i>[:CONFigure]:COMMunication:PROTOcol</i>	Changes the communication protocol
OUTPut Subsystem	
<i>OUTPut:PROTection:CLEar</i>	Reset soft faults
<i>OUTPut</i>	
<i>OUTPut:START</i>	
<i>OUTPut:STOP</i>	Disables the DC output
MEASure Subsystem	
<i>MEASure[:SCALAR]:ALL[:DC]?</i>	Measures and returns the average current, voltage, resistance, and power at the sense location
<i>MEASure[:SCALAR]:CURRent[:DC]?</i>	Measures and returns the average current at the sense location
<i>MEASure[:SCALAR]:POWer[:DC]?</i>	Measures and returns the instantaneous DC power at sense location
<i>MEASure[:SCALAR]:VOLTage[:DC]?</i>	Measures and returns the average voltage at the sense location
SOURce Subsystem	
<i>[:SOURce]:CURRent</i>	Sets the current set-point
<i>[:SOURce]:CURRent:PROTection:OVER</i>	Sets the over current trip (OCT) set-point
<i>[:SOURce]:CURRent:SLEW:FALL</i>	Sets the falling slew rate for current when in current regulation state
<i>[:SOURce]:CURRent:SLEW:RISE</i>	Sets the rising slew rate for current when in current regulation state

continues on next page

Table 9.1 – continued from previous page

SCPI Command	Description
<i>[.:SOURce]:CURRent:SLEW[:BOTH]</i>	Sets the slew rate for both rising and falling transitions in current regulation
<i>[.:SOURce]:POWer</i>	Sets the power set-point
<i>[.:SOURce]:POWer:PROTection:OVER</i>	Sets the over power trip (OPT) set-point
<i>[.:SOURce]:POWer:SLEW:FALL</i>	Sets the falling slew rate for power when in power regulation
<i>[.:SOURce]:POWer:SLEW:RISE</i>	Sets the rising slew rate for power when in power regulation state
<i>[.:SOURce]:POWer:SLEW[:BOTH]</i>	Sets the slew rate for both rising and falling power transitions in power regulation
<i>[.:SOURce]:SETPoint</i>	Sets all set-points using one command
<i>[.:SOURce]:VOLTage</i>	Sets the voltage set-point
<i>[.:SOURce]:VOLTage:PROTection:LOW</i>	Sets the under voltage trip (UVT) set-point
<i>[.:SOURce]:VOLTage:PROTection:OVER</i>	Sets the over voltage trip (OVT) set-point
<i>[.:SOURce]:VOLTage:SLEW:FALL</i>	Sets the falling slew rate for voltage when in voltage regulation state
<i>[.:SOURce]:VOLTage:SLEW:RISE</i>	Sets the rising slew rate for voltage when in voltage regulation state
<i>[.:SOURce]:VOLTage:SLEW[:BOTH]</i>	Sets the slew rate for rising and falling voltage transitions in voltage regulation
STATus Subsystem	
<i>*CLS</i>	Clear all status registers
<i>*ESE</i>	Configure Event Status Enable Register
<i>*ESR?</i>	Read Event Status Register
<i>*IDN?</i>	Product identification
<i>*OPC</i>	Operation Complete Bit
<i>*RST</i>	Reset to factory default states
<i>*SRE</i>	Service Request Enable Register
<i>*STB?</i>	Status Byte
<i>*TST?</i>	Execute self-test
<i>*WAI</i>	Wait till complete
<i>STATus:QUEStionable:CONDition?</i>	Returns the value of the Questionable Status register
<i>STATus:REGister<n>?</i>	Status RegisterNum
<i>STATus:REGister?</i>	Status Register
SYSTem Subsystem	
<i>SYSTem:ERRor:COUNt?</i>	Returns number of errors in queue
<i>SYSTem:ERRor[:NEXT]?</i>	Returns error type and message
<i>SYSTem:REBoot</i>	Reboots the system to power ON state
<i>SYSTem:VERsion?</i>	Returns hardware revision and firmware version
<i>[SYSTem][:COMMunicate]:NETwork:AD-Dress</i>	Set the static IP address
<i>[SYSTem][:COMMunicate]:NETwork:DHCP</i>	Set DHCP operation mode
<i>[SYSTem][:COMMunicate]:NETwork:GATE</i>	Set the Gateway IP address
<i>[SYSTem][:COMMunicate]:NETwork:HOST-name?</i>	Return hostname
<i>[SYSTem][:COMMunicate]:NETwork:MAC?</i>	Returns MAC address
<i>[SYSTem][:COMMunicate]:NETwork:PORT</i>	Set the socket number
<i>[SYSTem][:COMMunicate]:NETwork:SER?</i>	Returns Ethernet module serial number
<i>[SYSTem][:COMMunicate]:NETwork:SUB-Net</i>	Set the subnet IP Mask address
<i>[SYSTem][:COMMunicate]:NETwork:VER-Sion?</i>	Returns firmware and hardware version of Ethernet module

9.2 SCPI Command Set

9.2.1 CONFigure Subsystem

CONFigure:CONTRol

This command configures the MagnaDC power supply's control mode. *Control Modes* provides more information about the various options.

Command Syntax CONFigure:CONTRol <NR1>

Parameters 1 (CURRENT) | 2 (VOLTAGE) | 3 (POWER) | 4 (RESISTANCE) | 5 (RHEOSTAT) | 6 (SHUNTREG)

Examples CONF:CONT 1

***RST Value** 1 (CURRENT)

Query Syntax CONFigure:CONTRol?

Return Parameter Format <NR1>

CONFigure:LOCK

This command configures the MagnaDC power supply's lock state. While locked, the stop button is the only functional button on the front panel. See *Lock* for more details on how lock works and how behaves relative to other locking inputs (front panel and digital input).

Command Syntax CONFigure:LOCK <bool>

Parameters 0 (OFF) | 1 (ON)

Examples CONF:LOCK 1, CONF:LOCK 0

***RST Value** N/A

Query Syntax CONFigure:LOCK?

Return Parameter Format <NR3>

CONFigure:RESTore

This command performs a *factory restore* to default EPROM values. Both Soft Restore and Hard Restore are available through command parameters.

Command Syntax CONFigure:RESTore <NR1>

Parameters 1 (Soft Restore) | 2 (Hard Restore)

Examples CONF:REST 1, CONF:REST 2

***RST Value** N/A

CONFigure:SENSe

This command configures where the MagnaDC power supply senses voltage. The sense location also effects how power and resistance are calculated. Local sensing monitors the directly across the output terminals. Remote sensing, as described in *Remote Sense Connection*, measures across the terminal JS2. This external connection can be used to improve regulation at the point of load, as is needed for example, in compensating voltage drops caused by wire resistance.

Command Syntax CONFigure:SENSe <NR1>

Parameters 0 (local) | 1 (remote)

Examples CONF:SENS 1

***RST Value** N/A

Query Syntax CONFigure:SENSe?

Return Parameter Format <NR1>

CONFigure:SOURce

The command selects and routes different set points sources to the digital controller. Operation of this feature is described in *Set Point Source*. By default, the source is set to *local* (value 0), where set points originating from the front panel or communication interfaces are routed to the SLx Series digital control. When the source is set to *function generator* (value 1), set points are generated internally, by a periodic function generator block. When *external analog input* (value 3) is set, the voltage(s) applied to the rear connector are converted into set points.

Command Syntax CONFigure:SOURce <NR1>

Parameters 0 (local) | 1 (function generator) | 2 (external analog input)

Examples CONF:SOUR 1

***RST Value** 0 (local)

Query Syntax CONFigure:SOURce?

Return Parameter Format <NR1>

[:CONFigure]:COMMunication:PROTOcol

This command changes the command protocol of the MagnaDC power supply.

Command Syntax [:CONFigure]:COMMunication:PROTOcol <NR1>

Parameters 0 (SCPI) | 1 (MagnaLINK) | 2 (Modbus) | 3 (Industrial Networks)

Examples COMM:PROT 1

***RST Value** 0 (SCPI)

Query Syntax [:CONFigure]:COMMunication:PROTOcol?

Return Parameter Format <NR1>

9.2.2 MEASure Subsystem

MEASure[:SCALar]:ALL[:DC]?

This query command returns the average measurements as a list for current, voltage, power, and resistance, respectively.

Query Syntax MEASure[:SCALar]:ALL[:DC]?

Examples MEAS:ALL?, MEASURE:ALL:DC?

Return Parameter Format <NR2>, <NR2>, <NR2>

MEASure[:SCALar]:CURRent[:DC]?

This query commands the MagnaDC power supply to measure and return the average current through the DC terminals.

Query Syntax MEASure[:SCALar]:CURRent[:DC]?

Examples MEAS:CURR?, MEASURE:CURRENT:DC?

Return Parameter Format <NR2>

MEASure[:SCALar]:POWer[:DC]?

This query commands commands the MagnaDC power supply to measure and return the average power at the DC terminals.

Query Syntax MEASure[:SCALar]:POWer[:DC]?

Examples MEAS:POW?, MEASURE:POWER:DC?

Return Parameter Format <NR2>

MEASure[:SCALar]:VOLTage[:DC]?

This query commands commands the MagnaDC power supply to measure and return the average voltage at the DC terminals. If the remote sense function is used and engaged, this command returns the voltage measured at the sense terminals.

Query Syntax MEASure[:SCALar]:VOLTage[:DC]?

Examples MEAS:VOLT?, MEASURE:VOLTAGE:DC?

Return Parameter Format <NR2>

9.2.3 OUTPut Subsystem

OUTPut:PROTection:CLEAr

This commands removes the latch that disables the input when a fault condition is detected, as further detailed in *Clear Command* documentation. All conditions that generate the fault must be resolved before the latch can be cleared. Once the fault has been cleared, the input can be re-enabled with the *OUTPut:PROTection:CLEAr* command.

Command Syntax OUTPut:PROTection:CLEAr

Examples INP:PROT:CLE

Alias OUTPut:PROTection:CLEAr <bool>

***RST Value** N/A

OUTPut

This command enables or disables the MagnaDC power supply output. A *1* indicates the product's power processing circuit is active and processing power, while a *0* indicates the power supply is in standby or faulted state.

Command Syntax OUTPut <bool>

Parameters 0 (OFF) | 1 (ON)

Examples OUTP 1

***RST Value** 0 (OFF)

Query Syntax OUTPut?

Return Parameter Format <bool>

OUTPut:START

This command energizes the isolation transform with a current-source inverter. The resulting output voltage and current values will depend on the active *Set Point Source*. Output will remain energized until the *OUTPut:START* command is issued or faulting condition occurs.

Command Syntax OUTPut:START

Examples OUTP:START

***RST Value** N/A

OUTPut:STOP

This command turns off the current-source inverter that was driving the isolation transformer. Whatever charge on output filter capacitors will discharge through the load and internal bleeder circuitry, until reaching zero voltage.

Command Syntax OUTPut:STOP

Examples OUTP:STOP

***RST Value** N/A

9.2.4 SOURce Subsystem

[:SOURce]:CURRent

This command programs the current set-point that the MagnaDC power supply will regulate to when operating in constant current mode.

Command Syntax [:SOURce]:CURRent <NRf+>

Parameters 0 through MAX | MINimum | MAXimum

Examples CURR 0.5, CURR 5

***RST Value** MINimum

Query Syntax [:SOURce]:CURRent?

Return Parameter Format <NR2>

[[:SOURce]:CURRent:PROTection:OVER

This command programs the over current trip (OCT) set-point. If the input current exceeds the over current trip set-point for multiple samples, the input is disconnected and an OCT fault is indicated.

Command Syntax [[:SOURce]:CURRent:PROTection:OVER <NRf+>

Parameters 0 through MAX | MINimum | MAXimum

Examples CURR:PROT:OVER 25.00

***RST Value** MAXimum

Query Syntax [[:SOURce]:CURRent:PROTection:OVER?

Return Parameter Format <NR2>

[[:SOURce]:CURRent:SLEW:FALL

This command sets the current slew rate for decreasing current transitions while in constant current regulation. MAXimum sets the slew to the fastest possible rate. MINimum sets the slew to the slowest rate. Slew rates less than the minimum value are set to MINimum. Slew rate settings less than the minimum value are set to MINimum. Slew rate settings greater than the maximum value are set to MAXimum.

Command Syntax [[:SOURce]:CURRent:SLEW:FALL <NRf+>

Parameters 1 to MAXimum [A/ms] | MAXimum | MINimum

Examples CURR:SLEW:FALL MAX, CURR:SLEW:FALL 22

***RST Value** MAXimum

Query Syntax [[:SOURce]:CURRent:SLEW:FALL?

Return Parameter Format <NR2>

[[:SOURce]:CURRent:SLEW:RISE

This command sets the current slew rate for increasing current transitions while in constant current regulation. MAXimum sets the slew to the fastest possible rate. MINimum sets the slew to the slowest rate. Slew rates less than the minimum value are set to MINimum. Slew rate settings less than the minimum value are set to MINimum. Slew rate settings greater than the maximum value are set to MAXimum.

Command Syntax [[:SOURce]:CURRent:SLEW:RISE <NRf+>

Parameters 1 to MAXimum [A/ms] | MAXimum | MINimum

Examples CURR:SLEW:RISE MAX, CURR:SLEW:RISE 22

***RST Value** MAXimum

Query Syntax [[:SOURce]:CURRent:SLEW:RISE?

Return Parameter Format <NR2>

[[:SOURce]:CURRent:SLEW[:BOTH]]

This command sets the current slew rate for current transitions in constant current regulation. This command programs both rising and falling slew rates, respectively. Although any slew rate value may be entered, the MagnaDC power supply selects a slew rate that is closest to the programmed value. MAXimum sets the slew to the fastest possible rate. MINimum sets the slew to the slowest rate. Slew rate settings less than the minimum value are set to MINimum. Slew rate settings greater than the maximum value are set to MAXimum.

Command Syntax [[:SOURce]:CURRent:SLEW[:BOTH] <NRf+>, <NRf+>

Parameters 1 to MAXimum [A/ms] | MAXimum | MINimum

Examples CURR:SLEW MAX, CURR:SLEW 0.2, 0.2

***RST Value** MAXimum

Query Syntax [[:SOURce]:CURRent:SLEW[:BOTH] ?

Return Parameter Format <NR2>, <NR2>

[[:SOURce]:POWER]

This command programs the power set-point, in watts, which the MagnaDC power supply will regulate to when operating in constant power mode.

Command Syntax [[:SOURce]:POWER <NRf+>

Parameters 0 through MAX | MINimum | MAXimum

Examples POW 223.6, POW 5225

***RST Value** MINimum

Query Syntax [[:SOURce]:POWER ?

Return Parameter Format <NR2>

[[:SOURce]:POWER:PROTECTION:OVER]

This command programs the over power trip (OPT) set-point. If the input power exceeds the over power trip set-point for multiple sample, the input is disconnected and an OPT fault is indicated.

Command Syntax [[:SOURce]:POWER:PROTECTION:OVER <NRf+>

Parameters 0 through MAX | MINimum | MAXimum

Examples POW:PROT:OVER 662.2

***RST Value** MAXimum

Query Syntax [[:SOURce]:POWER:PROTECTION:OVER ?

Return Parameter Format <NR2>

[[:SOURce]:POWER:SLEW:FALL]

This command sets the power slew rate for decreasing power transitions while in constant power regulation. The units for power slew rate are watts per millisecond. MAXimum sets the slew to the fastest possible rate. MINimum sets the slew to the slowest rate. Slew rates less than the minimum value are set to MINimum. Slew rate settings less than the minimum value are set to MINimum. Slew rate settings greater than the maximum value are set to MAXimum.

Command Syntax [[:SOURce]:POWER:SLEW:FALL <NRf+>

Parameters 1 to MAXimum [W/ms] | MAXimum | MINimum

Examples POW:SLEW:FALL MAX, POW:SLEW:FALL 24

***RST Value** MAXimum

Query Syntax [[:SOURce]:POWER:SLEW:FALL?

Return Parameter Format <NR2>

[[:SOURce]:POWER:SLEW:RISE]

This command sets the power slew rate for increasing power transitions while in constant power regulation. The units for power slew rate are watts per millisecond. MAXimum sets the slew to the fastest possible rate. MINimum sets the slew to the slowest rate. Slew rates less than the minimum value are set to MINimum. Slew rate settings less than the minimum value are set to MINimum. Slew rate settings greater than the maximum value are set to MAXimum.

Command Syntax [[:SOURce]:POWER:SLEW:RISE <NRf+>

Parameters 1 to MAXimum [W/ms] | MAXimum | MINimum

Examples POW:SLEW:RISE MAX, POW:SLEW:RISE 39

***RST Value** MAXimum

Query Syntax [[:SOURce]:POWER:SLEW:RISE?

Return Parameter Format <NR2>

[[:SOURce]:POWER:SLEW[:BOTH]]

This command sets the power slew rate for the MagnaDC power supply while in constant power regulation. This command programs both rising and falling slew rates, respectively. The units for power slew rate are watts per millisecond. Although any slew rate value may be entered, the MagnaDC power supply selects a slew rate that is closest to the programmed value. MAXimum sets the slew to the fastest possible rate. MINimum sets the slew to the slowest rate. Slew rate settings less than the minimum value are set to MINimum. Slew rate settings greater than the maximum value are set to MAXimum.

Command Syntax [[:SOURce]:POWER:SLEW[:BOTH] <NRf+>, <NRf+>

Parameters 1 to MAXimum [W/ms] | MAXimum | MINimum

Examples POW:SLEW MAX, POW:SLEW 50, 50

***RST Value** MAXimum

Query Syntax [[:SOURce]:POWER:SLEW[:BOTH]?

Return Parameter Format <NR2>, <NR2>

[:SOURce]:SETPoint

This command programs all set-points using the list of values: current, voltage, power, and resistance, respectively.

Command Syntax [:SOURce]:SETPoint <NRf+>[mA|A], <NRf+>[mV|V]

Parameters 0 through MAX | MINimum | MAXimum

Examples SETPT 1.5, 1000.0, 1500.0

***RST Value** MINimum

Query Syntax [:SOURce]:SETPoint?

Return Parameter Format <NR2>, <NR2>, <NR2>

[:SOURce]:VOLTage

This command programs the voltage set-point, in volts, which the MagnaDC power supply will regulate to when operating in constant voltage mode.

Command Syntax [:SOURce]:VOLTage <NRf+>

Parameters 0 through MAX | MINimum | MAXimum

Examples VOLT 223.6, VOLT 552.5

***RST Value** MINimum

Query Syntax [:SOURce]:VOLTage?

Return Parameter Format <NR2>

[:SOURce]:VOLTage:PROTection:LOW

This command programs the under voltage trip (UVT) set-point. If the input voltage falls below the under voltage trip set-point for multiple samples, the input is disconnected and an UVT fault is indicated.

Command Syntax [:SOURce]:VOLTage:PROTection:LOW <NRf+>

Parameters 0 through MAX | MINimum | MAXimum

Examples VOLT:PROT:LOW 32.5

***RST Value** MAXimum

Query Syntax [:SOURce]:VOLTage:PROTection:LOW?

Return Parameter Format <NR2>

[:SOURce]:VOLTage:PROTection:OVER

This command programs the over voltage trip (OVT) set-point. If the input voltage exceeds the over voltage trip set-point for multiple samples, the input is disconnected and an OVT fault is indicated.

Command Syntax [:SOURce]:VOLTage:PROTection:OVER <NRf+>

Parameters 0 through MAX | MINimum | MAXimum

Examples VOLT:PROT:OVER 662.2

***RST Value** MAXimum

Query Syntax [:SOURCE]:VOLTage:PROTection:OVER?

Return Parameter Format <NR2>

[[:SOURCE]:VOLTage:SLEW:FALL

This command sets the voltage slew rate for decreasing voltage transitions while in constant voltage regulation. The units for voltage slew rate are volts per millisecond. MAXimum sets the slew to the fastest possible rate. MINimum sets the slew to the slowest rate. Slew rates less than the minimum value are set to MINimum. Slew rate settings less than the minimum value are set to MINimum. Slew rate settings greater than the maximum value are set to MAXimum.

Command Syntax [:SOURCE]:VOLTage:SLEW:FALL <NRf+>

Parameters 1 to MAXimum [V/ms] | MAXimum | MINimum

Examples VOLT:SLEW:FALL MAX,VOLT:SLEW:FALL 24

***RST Value** MAXimum

Query Syntax [:SOURCE]:VOLTage:SLEW:FALL?

Return Parameter Format <NR2>

[[:SOURCE]:VOLTage:SLEW:RISE

This command sets the voltage slew rate for increasing voltage transitions while in constant voltage regulation. The units for voltage slew rate are volts per millisecond. MAXimum sets the slew to the fastest possible rate. MINimum sets the slew to the slowest rate. Slew rates less than the minimum value are set to MINimum. Slew rate settings less than the minimum value are set to MINimum. Slew rate settings greater than the maximum value are set to MAXimum.

Command Syntax [:SOURCE]:VOLTage:SLEW:RISE <NRf+>

Parameters 1 to MAXimum [V/ms] | MAXimum | MINimum

Examples VOLT:SLEW:RISE MAX,VOLT:SLEW:RISE 39

***RST Value** MAXimum

Query Syntax [:SOURCE]:VOLTage:SLEW:RISE?

Return Parameter Format <NR2>

[[:SOURCE]:VOLTage:SLEW[:BOTH]

This command sets the voltage slew rate for the MagnaDC power supply while in constant voltage regulation. This command programs both rising and falling slew rates, respectively. The units for voltage slew rate are volts per millisecond. Although any slew rate value may be entered, the MagnaDC power supply selects a slew rate that is closest to the programmed value. MAXimum sets the slew to the fastest possible rate. MINimum sets the slew to the slowest rate. Slew rate settings less than the minimum value are set to MINimum. Slew rate settings greater than the maximum value are set to MAXimum.

Command Syntax [:SOURCE]:VOLTage:SLEW[:BOTH] <NRf+>, <NRf+>

Parameters 1 to MAXimum [V/ms] | MAXimum | MINimum

Examples VOLT:SLEW MAX,VOLT:SLEW 50,50

***RST Value** MAXimum

Query Syntax [:SOURCE]:VOLTage:SLEW[:BOTH]?

Return Parameter Format <NR2>, <NR2>

9.2.5 STATus Subsystem

Status commands let you determine the condition of the MagnaDC power supply at any time, grouping together multiple feedback parameters into one returned value.

*CLS

This command clears all status register (*ESR*, *STB* and error queue).

Command Syntax *CLS

Parameters None

Examples *CLS

***RST Value** N/A

*ESE

This command programs the Event Status Enable Register (ESE). The programming determines which events of the *Event Status Register (ESR)* set the Event Status Bit (ESB) of the Status Byte Register (STB). A “1” in the bit position enables the corresponding event. All of the enabled events of the ESE are logically OR’d to cause the ESB of the STB to be set.

Command Syntax *ESE <NR1>

Parameters Register Bit Position

Examples *ESE 255

***RST Value** N/A

Query Syntax *ESE?

Return Parameter Format <NR1>

*ESR?

This query reads the Event Status Register (ESR). After reading the ESR, the register is cleared. The bit configuration of the ESR is the same as the Event Status Enable Register (*ESE). The return parameter is weighted as shown in table below.

Query Syntax *ESR?

Examples *ESR?

***RST Value** N/A

Return Parameter Format <NR1>

Event Status Register

Bit	Weight	Abbreviation	Description
0	1	OPC	Operation Complete
1	2	NU	Not Used
2	4	QYE	Query Error
3	8	DDE	Device Dependent Error
4	16	EXE	Execution Error
5	32	CME	Command Error
6	64	NU	Not Used
7	128	PON	Power On Event, 1 after power on

*IDN?

This query requests MagnaDC power supply to identify itself, returning a string composed of three fields separated by commas.

Query Syntax *IDN?

Examples *IDN?

***RST Value** N/A

Return Parameter Format Company Name, MagnaDC power supply Model, Serial Number, Firmware Version

Return Example Magna-Power Electronics Inc., ARx16.75-1000-14, 1201-0001, 0.029

*OPC

This command clears the operation complete bit found in the event status register (*ESR*). Should be used in application programming when delay exists between sending a SCPI command and the execution of the command. When all commands have completed, the OPC bits gets set back to 1.

Command Syntax *OPC

Parameters None

Examples *OPC

***RST Value** N/A

Query Syntax *OPC?

Return Parameter Format <NR1>

*RST

This command resets the various settings and functions in the MagnaDC power supply to their factory default state. This command is commonly used in initialization routines to restore the MagnaDC power supply to a known configuration. Factory default settings for each command are indicated in the description for respective SCPI commands. SCPI commands with *RST Value indicated as *N/A* either are not affected by the *RST or do not have a parameter that can be changed.

Command Syntax *RST

Examples *RST

***RST Value** N/A

***SRE**

This command sets the Service Request Enable Register (SRE). This register, defined in the table “Service Request Enable Register”, determines which bits from the Status Byte Register (see *STB for its bit configuration) are allowed to set the Service Request (RQS) Bit. A 1 in any SRE bit position enables the corresponding Status Byte Register bit. All Status Byte Register enabled bits are then logically OR'd and placed in bit 6 of the Status Byte Register. When *SRE is cleared (by programming it with 0), the power supply cannot generate a service request to the controller.

Command Syntax *SRE <NR1>

Parameters Register Bit Position

Examples *SRE 20

***RST Value** N/A

Query Syntax *SRE?

Return Parameter Format <NR1>

Service Request Enable Register

Bit	Weight	Abbreviation	Description
0	1	NU	Not Used
1	2	NU	Not Used
2	4	NU	Not Used
3	8	QUES	Questionable Status Bit
4	16	MAV	Message Available Bit
5	32	ESB	Event Status Bit
6	64	RQS	Request Service Bit
7	128	NU	Not Used

***STB?**

This query gets the Status Byte (STB). Registers are cleared only when the signals feeding it are cleared.

Query Syntax *STB?

Examples *STB?

***RST Value** N/A

Return Parameter Format <NR1>

***TST?**

Executes a self-test routine that validates the operational condition of the MagnaDC power supply. If all tests pass, a 0 is returned, if any test fails, 1 is returned.

Query Syntax *TST?

Examples *TST?

***RST Value** N/A

Return Parameter Format <NR1>

***WAI**

Buffer commands until all previous commands have completed execution.

Command Syntax *WAI

Examples *TST; *WAI; INP:START

***RST Value** N/A

STATus:QUEStionable:CONDition?

This command queries and returns the values of the Questionable Register. This read-only register holds the live (unlatched) questionable statuses of the MagnaDC power supply. Issuing this query does not clear the register. The bit configuration of the Questionable Register is shown in the table below.

Query Syntax STATus:QUEStionable:CONDition?

Examples STAT:QUES:COND?

***RST Value** No Effect

Return Parameter Format <bit value>

Questionable Register

Bit	Weight	Abbreviation	Description
0	1	OVP	over voltage protection, hard fault
1	2	OCT	over current trip, soft fault
2	4	OVT	over voltage trip, soft fault
3	8	OPT	over power trip, soft fault
4	16	OCP	over current protection, hard fault
5	32	OTP	over temperature protection, hard fault
6	64	RSL	remote sense loss, hard fault
7	128	CC	constant current regulation, regulation status
8	256	CV	constant voltage regulation, regulation status
9	512	CR	constant resistance regulation, regulation status
10	1024	CP	constant power regulation, regulation status
11	2048	SFLT	soft fault, the ord value of all soft faults
12	4096	HFLT	hard fault, the ord value of all hard faults
13	8192	ILOC	interlock open
14	16384	IPL	input power loss fault
15	32768	ADIF	analog or digital input fault

STATus:REGister<n>?

This command queries a specific Status Register. The status registers are zero-indexed. These read-only registers hold the live (unlatched) operation status of the MagnaDC power supply. Issuing a query does not clear the registers. The register location and definitions are subject to change after any firmware release to accommodate new features. The *Questionable Register* is a subset of the status register and does not change between firmware updates. The present bit assignments are shown in the tables for *Status Register*.

Query Syntax STATus:REGister<n>?

Examples STAT:REG0?

***RST Value** No Effect

Return Parameter Format <NR1>**STATus:REGister?**

This command queries the Status Register. This read-only register holds the live (unlatched) operation status of the MagnaDC power supply. Issuing a query does not clear the register. The register location and definitions are subject to change after any firmware release to accommodate new features. The *Questionable Register* is a subset of the status register and does not change between firmware updates. The present bit assignments are shown in the table below.

Query Syntax STATus:REGister?

Examples STAT:REG?

***RST Value** No Effect

Return Parameter Format <NR1>, <NR1>

Status Register 0

Bit	Name	Description
0	standby	output is in standby
1	live	output is active
2	nonhalt1	available
3	nonhalt2	available
4	overCurrTrip	over current trip
5	overVoltTrip	over voltage trip
6	overPwrTrip	over power trip
7	remoteSenseLoss	remote sense voltage outside of acceptable bounds
8	underVoltTrip	under voltage trip
9	shutdown	target is creating a shutdown condition
10	linPwrLim	power across linear modules exceed ratings
11	resPwrLim	power across resistors exceed ratings
12	bootFailure	one or multiple target did not boot up
13	bootState	one or more targets are waiting to boot
14	phaseCurr	rated phase current exceeded
15	comm	communications are corrupted
16	overCurrProtect	terminal current exceeded product rating
17	overVoltProtect	terminal voltage exceeded product rating
18	tempRLin	linear module exceeded temperature
19	blownFuse	fuse is blown on the auxiliary power supply
20	interlock	interlock open
21	haltUserClear	available
22	maintenance	maintenance
23	tempDMod	diode modules exceeded temperature
24	incompatibleSysConfig	incompatible system configuration
25	stackOverflow	exceeded firmware stack
26	lineFault	line fault analog/digital inputs
27	tempRMod	resistor module exceeded temperature
28	belowRatedMinVolt	below minimum voltage rating(28)
29	outOfRegulation	out of regulation, unexpected currents measured
30	targetUpgrade	mainctrl upgrading other targets
31	haltSelfClear	available

Status Register 1

Bit	Name	Description
0	phaseLoss	one or more phase missing
1	blownFuseInput	input fuse blown on fuse/emi filter
2	fanLockedRotor	one or more fan's rotor has locked
3	notUsed29	available
4	tempPwrMod	power processing module temperature fault
5	tempOutputMod	output filter module temperature fault
6	tempOutputCap	output capacitors temperature fault
7	tempTransformer	transformer exceeded temperature fault
8	notUsed26	available
9	notUsed27	available
10	notUsed28	available
11	notUsed1	available
12	notUsed2	available
13	notUsed3	available
14	notUsed4	available
15	notUsed5	available
16	invalidSysRating	invalid system rating
17	fwVersConflict	firmware version conflict
18	notUsed8	available
19	notUsed9	available
20	notUsed10	available
21	notUsed11	available
22	notUsed12	available
23	notUsed13	available
24	notUsed14	available
25	notUsed15	available
26	notUsed16	available
27	notUsed17	available
28	notUsed18	available
29	notUsed19	available
30	notUsed20	available
31	notUsed21	available

9.2.6 SYSTEM Subsystem

SYSTEM:ERROR:COUNT?

This query reads the number of errors in the error queue.

Query Syntax SYSTEM:ERROR:COUNT?

Examples SYST:ERR:COUN?

Return Parameter Format <NR1>

SYSTem:ERRor[:NEXT]?

The SYST:ERR? query returns the error type and message that occurred in the system. The format of the return string is an error number followed by corresponding error message string. The errors are stored in a FIFO (first-in, first-out) buffer. As the errors are read, they are removed from the queue. When all errors have been read, the query returns 0, “NO ERROR.” If more errors have accumulated than the queue can hold, the last error in the queue will be -350, “Queue Overflow.” When system errors occur, the Standard Event Status Register (ESR), records the error groups as defined in the table Error Bits table below. The Error Message table below lists system errors that are associated with SCPI syntax errors and with interface problems.

Query Syntax SYSTem:ERRor[:NEXT]?

Examples SYST:ERR?, SYSTEM:ERROR?

Return Parameter Format <NR1>, <string>

Standard Event Status Register Error Bits

Bit	Error Code	Error Type
5	100 through -199	Command
4	200 through -299	Execution
3	300 through -399	Device dependent
2	400 through -499	Query

Error Messages

Bit	Error String	Error Error Description
-100	Command error	Generic Command error
-102	Syntax error	Unrecognized command or data type
-108	Parameter not allowed	Too many parameters
-222	Data out of range	Value provided outside device's range
-350	Queue overflow	Errors lost due to too many errors in queue
-400	Query Error	Generic query error

SYSTem:REBoot

This commands reboots the system and clears any hard faults.

Command Syntax SYSTem:REBoot

Examples SYST:REB, SYSTEM:REBOOT

***RST Value** N/A

SYSTem:VERSion?

The SYST:VERS? query returns the MagnaDC power supply's bootloader, firmware, and hardware revision, respectively. The returned value is a comma-separated list of values.

Query Syntax SYSTem:VERSion?

Examples SYST:VERS?, SYSTEM:VERSION?

Return Parameter Format <NR2>, <NR2>, <NR2>

[SYSTEM][:COMMunicate]:NETwork:ADDRess

This command sets the static address of the Ethernet module of the MagnaDC power supply. The factory default address setting is 192.168.1.100.

Command Syntax [SYSTEM] [:COMMunicate]:NETwork:ADDRess <string>

Parameters IP address is represented with 4 bytes each having a range of 0-255 separated by periods

Examples SYSTem:COMM:NET:ADDR 192.168.10.2, NET:ADDR 192.168.10.2

Query Syntax [SYSTEM] [:COMMunicate]:NETwork:ADDRess?

Return Parameter Format <string>

[SYSTEM][:COMMunicate]:NETwork:DHCP

This command sets the DHCP operating mode of the Ethernet module. If DHCP is set to 1, the module will allow its IP address to be automatically set by the DHCP server on the network. If DHCP is set to 0, the default IP address is set according to .

Command Syntax [SYSTEM] [:COMMunicate]:NETwork:DHCP <bool>

Parameters 0 (DHCP Off) | 1 (DHCP On)

Examples SYST:COMM:NET:DHCP 0, NET:DHCP 1

Query Syntax [SYSTEM] [:COMMunicate]:NETwork:DHCP?

Return Parameter Format <NR1>

[SYSTEM][:COMMunicate]:NETwork:GATE

This command sets the Gateway IP address of the Ethernet module of the MagnaDC power supply. The factory default Gateway IP setting is 192.168.1.1.

Command Syntax [SYSTEM] [:COMMunicate]:NETwork:GATE <string>

Parameters Gateway IP address is represented with 4 bytes each having a range of 0-255 separated by dots

Examples SYSTem:COMM:NET:GATE 192.168.10.2, NET:GATE 192.168.10.2

Query Syntax [SYSTEM] [:COMMunicate]:NETwork:GATE?

Return Parameter Format <string>

[SYSTEM][:COMMunicate]:NETwork:HOSTname?

This query reads the host name of the Ethernet communications module.

Query Syntax [SYSTEM] [:COMMunicate]:NETwork:HOSTname?

Examples SYST:COMM:NET:HOST?, NET:HOST?

Return Parameter Format <string>

[SYSTEM][:COMMunicate]:NETwork:MAC?

This query returns the MAC address of the Ethernet module. MAC address consist of two number groups: the first three bytes are known as the Organizationally Unique Identifier (OUI), which is distributed by the IEEE, and the last three bytes are the device's unique serial number. The six bytes are separated by hyphens. The MAC address is unique to the instrument and cannot be altered by the user.

Query Syntax [SYSTEM] [:COMMunicate]:NETwork:MAC?

Examples SYST:COMM:NET:MAC?, NET:MAC?

Return Parameter Format <string>

[SYSTEM][:COMMunicate]:NETwork:PORT

This command sets the Socket (Port) of the Ethernet module of the MagnaDC power supply. The factory default port setting is 50505. The factory recommends port values greater than 49151 to avoid conflicts with registered Ethernet port functions.

Command Syntax [SYSTEM] [:COMMunicate]:NETwork:PORT <NR1>

Parameters 16-bit socket number (1 to 65,535)

Examples SYSTEM:COMM:NET:PORT 50505, NET:PORT 50505

Query Syntax [SYSTEM] [:COMMunicate]:NETwork:PORT?

Return Parameter Format <NR1>

[SYSTEM][:COMMunicate]:NETwork:SER?

This command returns the serial number of the Ethernet module. The serial number is an integer ranging from 1 to 16777215 and cannot be altered by the user.

Query Syntax [SYSTEM] [:COMMunicate]:NETwork:SER?

Examples SYST:COMM:NET:SER?, NET:SER?

Return Parameter Format <NR1>

[SYSTEM][:COMMunicate]:NETwork:SUBNet

This command sets the subnet IP Mask address of the Ethernet module of the MagnaDC power supply. The factory subnet mask setting is 255.255.255.0.

Command Syntax [SYSTEM] [:COMMunicate]:NETwork:SUBNet <string>

Parameters IP mask address is represented with 4 bytes each having a range of 0-255 separated by periods.

Examples SYSTEM:COMM:NET:SUBNet 255.255.255.128, NET:SUBNet 255.255.255.
128

Query Syntax [SYSTEM] [:COMMunicate]:NETwork:SUBNet?

Return Parameter Format <string>

[SYSTem][:COMMunicate]:NETwork:VERSion?

This query reads the firmware and hardware versions of the Ethernet communications module.

Query Syntax [SYSTem] [:COMMunicate] :NETwork:VERSion?

Examples SYST:COMM:NET:VERS?, NET:VERS?

Return Parameter Format <string> (e.g. Firmware Ver. XX.Y, Hardware Rev. XX.Y)

MODBUS COMMAND SET

10.1 Modbus RTU over Serial

Modbus RTU is a serial communication protocol that allows devices to communicate over the provided serial interfaces (USB and RS-485). The following connection settings must be used to connect to Modbus RTU on Magna-Power products:

- Baud Rate: 115200
- Parity: None
- Data Bits: 8 bits

If the serial connection settings are configured incorrectly, Modbus messages may result in framing or CRC timeout errors. Further information about framing errors can be found in [Error Handling](#).

Bit Allocation - Read Holding Registers (Function Code = 0x03)

Slave Address	Function Code	Starting Address (Hi)	Starting Address (Lo)	Register Count (Hi)	Register Count (Lo)	CRC (Lo)	CRC (Hi)
0-7	8-15	16-23	24-31	32-39	40-47	48-55	56-63

Bit Allocation - Write Single Register (Function Code = 0x06)

Slave Address	Function Code	Starting Address (Hi)	Starting Address (Lo)	Write Data (Hi)	Write Data (Lo)	CRC (Lo)	CRC (Hi)
0-7	8-15	16-23	24-31	32-39	40-47	48-55	56-63

Bit Allocation - Write Multiple Registers (Function Code = 0x10)

Slave Address	Function Code	Starting Address (Hi)	Starting Address (Lo)	Register Count (Hi)	Register Count (Lo)	Byte Count	Data (Hi)	Data (Lo)	Data (Hi)	Data (Lo)	CRC (Lo)	CRC (Hi)
0-7	8-15	16-23	24-31	32-39	40-47	48-55	56-63	64-71	72-79	80-87	88-95	96-103

10.2 Modbus Terminology

Slave Address Address of the device to be communicated to. See *Device Addressing Mode* for details

Function Code Defines the type of action to be performed by the device. See *Functions* for details.

Starting Address Hi/Lo High/low bytes of the register address the command is referencing. In Table 2, this is listed as the Address.

Register Count Hi/Lo Number of registers that the command is referencing. In *Register List*, this is listed as the Register Count. Ex. A register count of 2 should have a Hi value of 00h and a Lo value of 02h

Byte Count Number of bytes referenced by the command. This number should be twice the Register Count.

Register Value Hi/Lo High/low value of what is stored in the registers. See *Data Format* to see how this data is formatted.

CRC Lo/Hi Cyclic Redundancy Check low and high bytes.

10.3 Device Addressing Mode

Modbus supports unicast and broadcast addressing modes.

In unicast mode request and response messages are sent by a master and slave nodes, respectively. In the master request, the slave address must be included to receive a response from a listening slave device. Magna-Power has this address set to 1.

In broadcast addressing mode, the master sends a request to all listening slaves, but none will respond. The slaves process the message and await the next request. To send a request in broadcast mode, the slave address must be set to 0.

10.4 Functions

Modbus protocol requires a function code, describing read write operations in the second byte of a message. In Table 1, a list of supported function codes and their uses are shown.

Table 1: Modbus Function Codes

Function Code	Name	Use
03 (0x03 Hex)	Read Holding Registers	Read 1-2 16-bit register(s)
06 (0x06 Hex)	Write Single Register	Write to 1 16-bit register
16 (0x10 Hex)	Write Multiple Registers	Write 2 16-bit registers

10.5 Data Format

10.5.1 Data Order

The order in which data is sent or received by the devices is a big-endian system, where the most significant 16-bit register should be sent first, and the following bytes should also go in order of most significant to least significant.

For example, the decimal value 123456789 (0x075BCD15 in hexadecimal), would be constructed and sent as a Modbus message as first 0x07, then 0x5B, 0xCD, and finally 0x15.

10.5.2 Floating Point Numbers

When reading or writing a register with a floating-point data format, as listed in *Register List*, the data should always be represented using IEEE-754 floating point notation, following the data order outlined in Data Order. For example, writing a value of 3.0 to a register should be sent in a Modbus message as 0x40, 0x40, 0x00, and 0x00.

10.6 Error Handling

Slave devices will respond with an error message if the request was not properly formatted for Magna-Power's Modbus implementation. The first byte of this error message will be a number above 0x80. The second byte will be the exception code, which identifies the type of error encountered. In Table 3, the possible exception codes that can be received are listed.

Table 3: Modbus Exception Codes

Code	Name	Causes
0x01	Illegal Function	<ul style="list-style-type: none"> A currently unsupported function code has been sent. See <i>Functions</i> for supported function codes.
0x02	Illegal Data Address	<ul style="list-style-type: none"> The number of registers specified in the message does not match. See <i>Register List</i> for register count. The register address and function code do not match any commands. See <i>Register List</i> for command list.
0x03	Illegal Data Value	<ul style="list-style-type: none"> The register count is outside the allowed count. Modify the register count to be 1-2 registers. The register count and byte count conflict. The number of bytes is two times the register count.

Slave will not respond under certain addressing modes and when a request is malformed or corrupted. Non-response can happen when:

- The queue has overflowed. To prevent overflow, allow more time between Modbus requests.
- The message is corrupt. This happens when the message's calculated CRC does not match the sent CRC, which can occur because of electrical noise or malformed messages. Ensure your software forms messages properly, using the correct byte ordering, and is calculating CRC correctly. Modbus CRC is sent low-order byte followed by high-order byte and is calculated using CRC-16.

- There is a framing error. This can happen when the serial connection is incorrect or if there is electrical noise. Refer to *Modbus RTU over Serial* on the proper serial configuration.
- The device is in broadcast addressing mode. By design slaves should not respond in broadcast since slaves' response messages would trample each other on the network. Verify that the slave address is set to 1 if a response is needed.

10.7 Communication Examples

The SLx Series must be explicitly configured to communicate using the Modbus protocol. The factory default is *SCPI Command Set*, but can be changed from in the front panel menu *Communication Setting-Command Protocol* by selecting *Modbus*. Modbus messages are binary and traditional terminal programs (e.g., PuTTY, HyperTerminal) design for ASCII serial can not be used for communicating with SLx Series. For all the following examples, the open-source Modbus specific program, *QModMaster* was used to construct messages. Each example outlines a function, its arguments, the request, and the expected response. A screen capture showing field entries in *QModMaster* are also shown below.

10.7.1 Example Request Source Setpoint

Request		Response	
Slave Address	0x01	Slave Address	0x01
Function Code	0x03	Function Code	0x03
Starting Address Hi	0x80	Byte Count	0x02
Starting Address Lo	0xB0	Register Value Hi	0x00
Register Count Hi	0x00	Register Value Lo	0x00
Register Count Lo	0x01	CRC Lo	0xB8
CRC Lo	0xAC	CRC Hi	0x44
CRC Hi	0x2D		

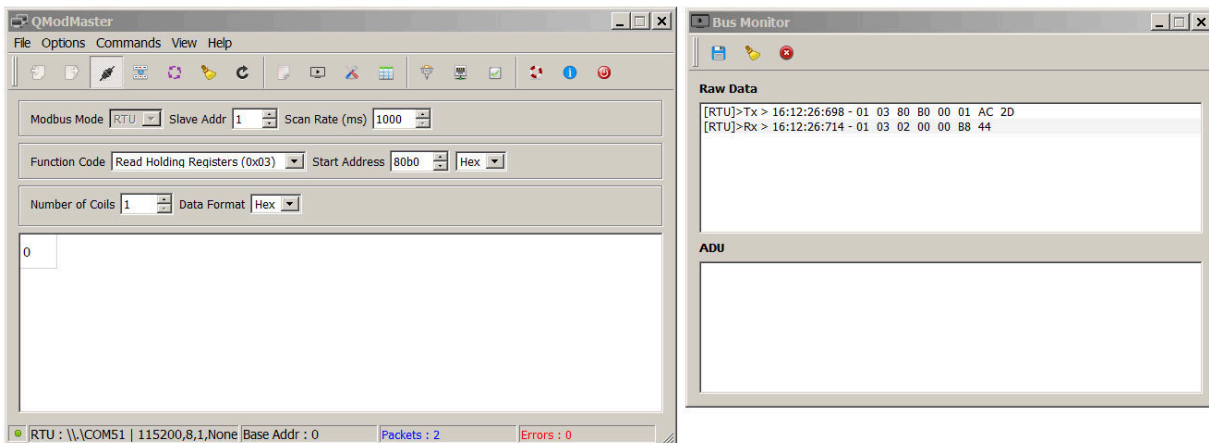

10.7.2 Example Set Front Panel Lock

Request		Response	
Slave Address	0x01	Slave Address	0x01
Function Code	0x06	Function Code	0x06
Register Address Hi	0x80	Register Address Hi	0x80
Register Address Lo	0x30	Register Address Lo	0x30
Register Value Hi	0x00	Register Value Hi	0x00
Register Value Lo	0x01	Register Value Lo	0x01
CRC Lo	0x61	CRC Lo	0x61
CRC Hi	0xC5	CRC Hi	0xC5

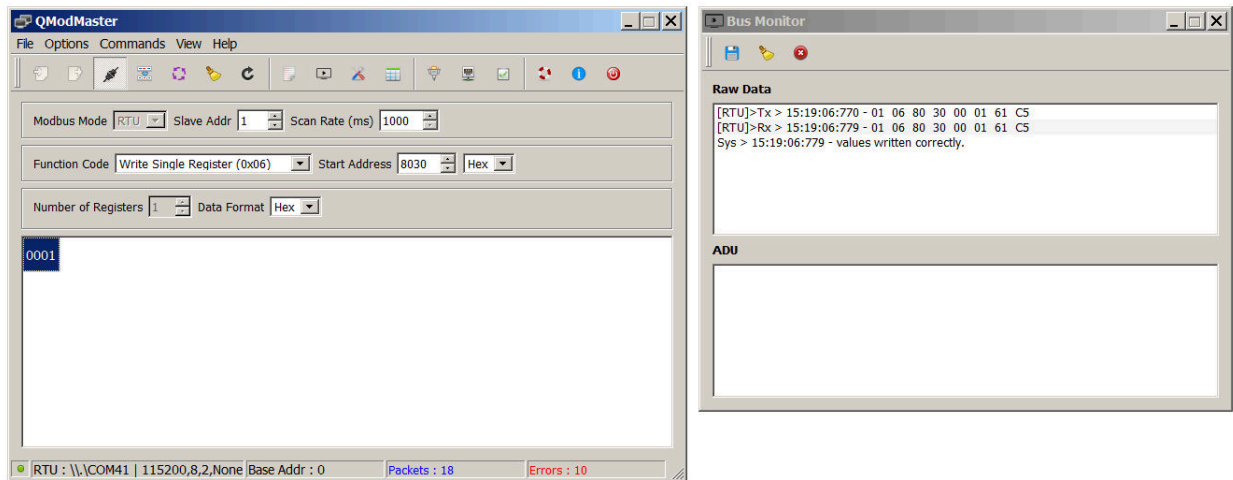

10.7.3 Example Write Current Setpoint to 5.00

Request		Response	
Slave Address	0x01	Slave Address	0x01
Function Code	0x10	Function Code	0x10
Starting Address Hi	0x30	Starting Address Hi	0x30
Starting Address Lo	0x10	Starting Address Lo	0x10
Register Count Hi	0x00	Register Count Hi	0x00
Register Count Lo	0x02	Register Count Lo	0x02
Byte Count	0x04	CRC Lo	0x4F
Register Value Hi	0x40	CRC Hi	0x0D
Register Value Lo	0xA0		
Register Value Hi	0x00		
Register Value Lo	0x00		
CRC Lo	0xB3		
CRC Hi	0x40		

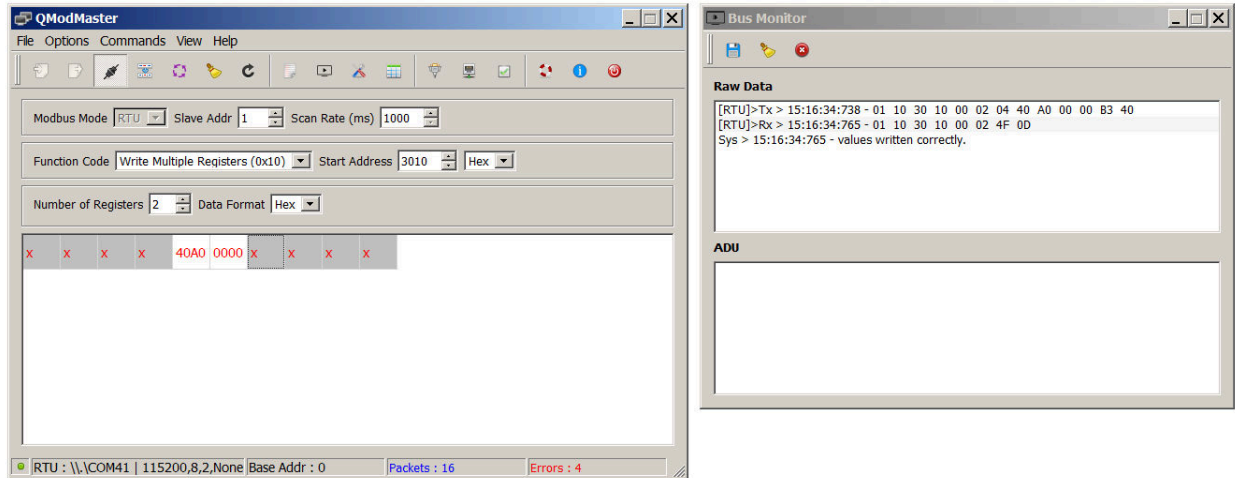

10.7.4 Example Request Current Setpoint (5.00)

Request		Response	
Slave Address	0x01	Slave Address	0x01
Function Code	0x03	Function Code	0x03
Starting Address Hi	0x30	Byte Count	0x04
Starting Address Lo	0x20	Register Value Hi	0x40
Register Count Hi	0x00	Register Value Lo	0x9F
Register Count Lo	0x02	Register Value Hi	0xFF
CRC Lo	0xCA	Register Value Lo	0x60
CRC Hi	0xCE	CRC Lo	0x9E
		CRC Hi	0x05

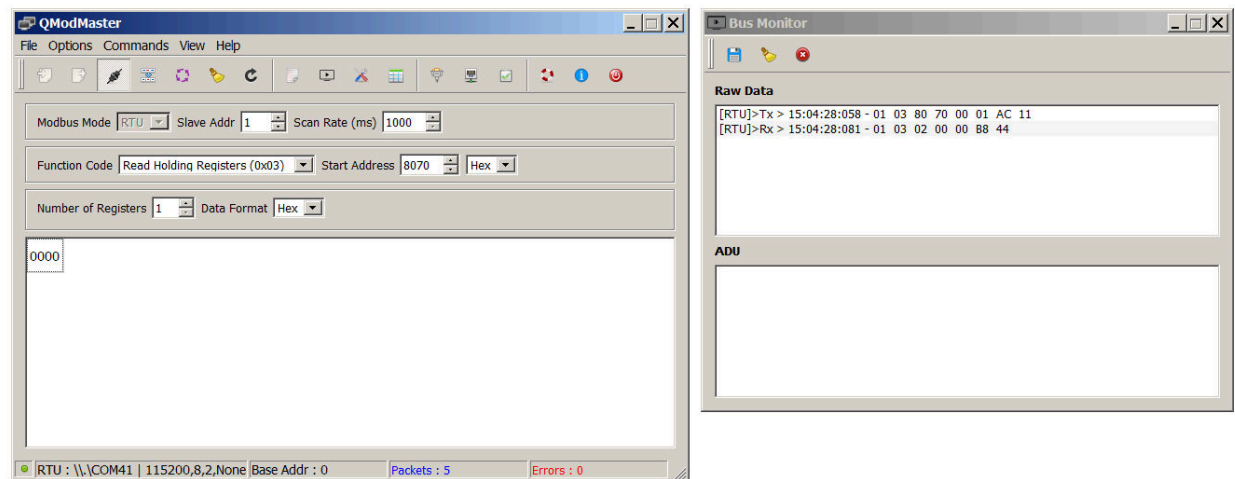

10.8 Register List

The Modbus protocol consists of requests to specific register addresses stored in memory. Each register contains stored value in memory that can be read from or written to. When a Modbus request is sent by a master to a register address, the listening slave device will respond in one of two ways. If the master's request was a read operation, the slave device will respond with the value stored at the register that was read. If the master's request was a write operation, the slave device will set the registers to the requested value and will respond with a confirmation that the registers were written to.

For instance, if the current set point needs to be read, the request message must specify the register address 0x3020, and the listening slave device will respond with its current set point value. Table 2 lists all the register addresses.

Modbus Command	Write Address	Read Address	Description
<i>StatusQuesQ</i>	N/A	0x10B0	Returns the value of the Questionable Status register
<i>StatusRegQ</i>	N/A	0x10D0	Status Register
<i>Output</i>	0x10F0	0x1100	
<i>MeasCurrQ</i>	N/A	0x2010	Measures and returns the average current at the sense location
<i>MeasVoltQ</i>	N/A	0x2020	Measures and returns the average voltage at the sense location
<i>MeasPwrQ</i>	N/A	0x2030	Measures and returns the instantaneous DC power at sense location
<i>SetpointCurr</i>	0x3010	0x3020	Sets the current set-point
<i>SetpointVolt</i>	0x3030	0x3040	Sets the voltage set-point
<i>SetpointPwr</i>	0x3050	0x3060	Sets the power set-point
<i>OverTripCurr</i>	0x4010	0x4020	Sets the over current trip (OCT) set-point
<i>OverTripVolt</i>	0x4030	0x4040	Sets the over voltage trip (OVT) set-point
<i>OverTripPwr</i>	0x4050	0x4060	Sets the over power trip (OPT) set-point
<i>UnderTripVolt</i>	0x4070	0x4080	Sets the under voltage trip (UVT) set-point
<i>RiseRampCurr</i>	0x5010	0x5020	Sets the rising slew rate for current when in current regulation state
<i>RiseRampVolt</i>	0x5030	0x5040	Sets the rising slew rate for voltage when in voltage regulation state
<i>RiseRampPwr</i>	0x5050	0x5060	Sets the rising slew rate for power when in power regulation state
<i>FallRampCurr</i>	0x5090	0x50A0	Sets the falling slew rate for current when in current regulation state
<i>FallRampVolt</i>	0x50B0	0x50C0	Sets the falling slew rate for voltage when in voltage regulation state
<i>FallRampPwr</i>	0x50D0	0x50E0	Sets the falling slew rate for power when in power regulation state
<i>ControlMode</i>	0x6030	0x6040	Sets the control mode
<i>FactoryRestore</i>	0x8010	N/A	Restores the factory EEPROM data
<i>Lock</i>	0x8030	0x8020	Locks and unlocks the product from configuration and set-point changes
<i>SenseMode</i>	0x8060	0x8070	Configures the sense location and automated compensation values
<i>CommProt</i>	0x8080	0x8090	Changes the communication protocol
<i>SetSource</i>	0x80A0	0x80B0	Sets the setpoint source

The Magna-Power implementation for Modbus limits reading/writing to one value (one to two registers) at a time. These

registers must be adjacent in memory. For example, for measuring both current and voltage, two separate requests from the master device are needed – one for current and one for voltage.

10.8.1 StatusQuesQ

This command queries and returns the values of the Questionable Register. This read-only register holds the live (unlatched) questionable statuses of the MagnaDC power supply. Issuing this query does not clear the register. The bit configuration of the Questionable Register is shown in the table below.

Address 0x10B0

Function Code 0x03

Access Read

Register Count 2

Data Format 32-bit Integer

Questionable Register

Bit	Weight	Abbreviation	Description
0	1	OVP	over voltage protection, hard fault
1	2	OCT	over current trip, soft fault
2	4	OVT	over voltage trip, soft fault
3	8	OPT	over power trip, soft fault
4	16	OCP	over current protection, hard fault
5	32	OTP	over temperature protection, hard fault
6	64	RSL	remote sense loss, hard fault
7	128	CC	constant current regulation, regulation status
8	256	CV	constant voltage regulation, regulation status
9	512	CR	constant resistance regulation, regulation status
10	1024	CP	constant power regulation, regulation status
11	2048	SFLT	soft fault, the ord value of all soft faults
12	4096	HFLT	hard fault, the ord value of all hard faults
13	8192	ILOC	interlock open
14	16384	IPL	input power loss fault
15	32768	ADIF	analog or digital input fault

10.8.2 StatusRegQ

This command queries the Status Register. This read-only register holds the live (unlatched) operation status of the MagnaDC power supply. Issuing a query does not clear the register. The register location and definitions are subject to change after any firmware release to accommodate new features. The *Questionable Register* is a subset of the status register and does not change between firmware updates. The present bit assignments are shown in the table below.

Address 0x10D0

Function Code 0x03

Access Read

Register Count 4

Data Format 32-bit Integer

Status Register

Bit	Name	Description
0	standby	output is in standby
1	live	output is active
2	nonhalt1	available
3	nonhalt2	available
4	overCurrTrip	over current trip
5	overVoltTrip	over voltage trip
6	overPwrTrip	over power trip
7	remoteSenseLoss	remote sense voltage outside of acceptable bounds
8	underVoltTrip	under voltage trip
9	shutdown	target is creating a shutdown condition
10	linPwrLim	power across linear modules exceed ratings
11	resPwrLim	power across resistors exceed ratings
12	bootFailure	one or multiple target did not boot up
13	bootState	one or more targets are waiting to boot
14	phaseCurr	rated phase current exceeded
15	comm	communications are corrupted
16	overCurrProtect	terminal current exceeded product rating
17	overVoltProtect	terminal voltage exceeded product rating
18	tempRLin	linear module exceeded temperature
19	blownFuse	fuse is blown on the auxiliary power supply
20	interlock	interlock open
21	haltUserClear	available
22	maintenance	maintenance
23	tempDMod	diode modules exceeded temperature
24	incompatibleSysConfig	incompatible system configuration
25	stackOverflow	exceeded firmware stack
26	lineFault	line fault analog/digital inputs
27	tempRMod	resistor module exceeded temperature
28	belowRatedMinVolt	below minimum voltage rating(28)
29	outOfRegulation	out of regulation, unexpected currents measured
30	targetUpgrade	mainctrl upgrading other targets
31	haltSelfClear	available
32	phaseLoss	one or more phase missing
33	blownFuseInput	input fuse blown on fuse/emi filter
34	fanLockedRotor	one or more fan's rotor has locked
35	notUsed29	available
36	tempPwrMod	power processing module temperature fault
37	tempOutputMod	output filter module temperature fault
38	tempOutputCap	output capacitors temperature fault
39	tempTransformer	transformer exceeded temperature fault
40	notUsed26	available
41	notUsed27	available
42	notUsed28	available
43	notUsed1	available
44	notUsed2	available
45	notUsed3	available
46	notUsed4	available
47	notUsed5	available

continues on next page

Table 10.1 – continued from previous page

Bit	Name	Description
48	invalidSysRating	invalid system rating
49	fwVersConflict	firmware version conflict
50	notUsed8	available
51	notUsed9	available
52	notUsed10	available
53	notUsed11	available
54	notUsed12	available
55	notUsed13	available
56	notUsed14	available
57	notUsed15	available
58	notUsed16	available
59	notUsed17	available
60	notUsed18	available
61	notUsed19	available
62	notUsed20	available
63	notUsed21	available

10.8.3 Output

This command enables or disables the MagnaDC power supply output. A *1* indicates the product's power processing circuit is active and processing power, while a *0* indicates the power supply is in standby or faulted state.

Address 0x10F0

Function Code 0x06

Access Write

Register Count 1

Parameters 0 (OFF) | 1 (ON)

Data Format Boolean

Query Address 0x1100

Function Code 0x03

Access Read

Register Count 1

Data Format 16-bit Integer

10.8.4 MeasCurrQ

This query commands the MagnaDC power supply to measure and return the average current through the DC terminals.

Address 0x2010

Function Code 0x03

Access Read

Register Count 2

Data Format 32-bit Floating Point Number

10.8.5 MeasVoltQ

This query commands commands the MagnaDC power supply to measure and return the average voltage at the DC terminals. If the remote sense function is used and engaged, this command returns the voltage measured at the sense terminals.

Address 0x2020

Function Code 0x03

Access Read

Register Count 2

Data Format 32-bit Floating Point Number

10.8.6 MeasPwrQ

This query commands commands the MagnaDC power supply to measure and return the average power at the DC terminals.

Address 0x2030

Function Code 0x03

Access Read

Register Count 2

Data Format 32-bit Floating Point Number

10.8.7 SetpointCurr

This command programs the current set-point that the MagnaDC power supply will regulate to when operating in constant current mode.

Address 0x3010

Function Code 0x10

Access Write

Register Count 2

Parameters 0 through MAX | MINimum | MAXimum

Data Format 32-bit Floating Point Number

Query Address 0x3020

Function Code 0x03

Access Read

Register Count 2

Data Format 32-bit Floating Point Number

10.8.8 SetpointVolt

This command programs the voltage set-point, in volts, which the MagnaDC power supply will regulate to when operating in constant voltage mode.

Address 0x3030

Function Code 0x10

Access Write

Register Count 2

Parameters 0 through MAX | MINimum | MAXimum

Data Format 32-bit Floating Point Number

Query Address 0x3040

Function Code 0x03

Access Read

Register Count 2

Data Format 32-bit Floating Point Number

10.8.9 SetpointPwr

This command programs the power set-point, in watts, which the MagnaDC power supply will regulate to when operating in constant power mode.

Address 0x3050

Function Code 0x10

Access Write

Register Count 2

Parameters 0 through MAX | MINimum | MAXimum

Data Format 32-bit Floating Point Number

Query Address 0x3060

Function Code 0x03

Access Read

Register Count 2

Data Format 32-bit Floating Point Number

10.8.10 OverTripCurr

This command programs the over current trip (OCT) set-point. If the input current exceeds the over current trip set-point for multiple samples, the input is disconnected and an OCT fault is indicated.

Address 0x4010

Function Code 0x10

Access Write

Register Count 2

Parameters 0 through MAX | MINimum | MAXimum

Data Format 32-bit Floating Point Number

Query Address 0x4020

Function Code 0x03

Access Read

Register Count 2

Data Format 32-bit Floating Point Number

10.8.11 OverTripVolt

This command programs the over voltage trip (OVT) set-point. If the input voltage exceeds the over voltage trip set-point for multiple samples, the input is disconnected and an OVT fault is indicated.

Address 0x4030

Function Code 0x10

Access Write

Register Count 2

Parameters 0 through MAX | MINimum | MAXimum

Data Format 32-bit Floating Point Number

Query Address 0x4040

Function Code 0x03

Access Read

Register Count 2

Data Format 32-bit Floating Point Number

10.8.12 OverTripPwr

This command programs the over power trip (OPT) set-point. If the input power exceeds the over power trip set-point for multiple sample, the input is disconnected and an OPT fault is indicated.

Address 0x4050

Function Code 0x10

Access Write

Register Count 2

Parameters 0 through MAX | MINimum | MAXimum

Data Format 32-bit Floating Point Number

Query Address 0x4060

Function Code 0x03

Access Read

Register Count 2

Data Format 32-bit Floating Point Number

10.8.13 UnderTripVolt

This command programs the under voltage trip (UVT) set-point. If the input voltage falls below the under voltage trip set-point for multiple samples, the input is disconnected and an UVT fault is indicated.

Address 0x4070

Function Code 0x10

Access Write

Register Count 2

Parameters 0 through MAX | MINimum | MAXimum

Data Format 32-bit Floating Point Number

Query Address 0x4080

Function Code 0x03

Access Read

Register Count 2

Data Format 32-bit Floating Point Number

10.8.14 RiseRampCurr

This command sets the current slew rate for increasing current transitions while in constant current regulation. MAXimum sets the slew to the fastest possible rate. MINimum sets the slew to the slowest rate. Slew rates less than the minimum value are set to MINimum. Slew rate settings less than the minimum value are set to MINimum. Slew rate settings greater than the maximum value are set to MAXimum.

Address 0x5010

Function Code 0x10

Access Write

Register Count 2

Parameters 1 to MAXimum [A/ms] | MAXimum | MINimum

Data Format 32-bit Floating Point Number

Query Address 0x5020

Function Code 0x03

Access Read

Register Count 2

Data Format 32-bit Floating Point Number

10.8.15 RiseRampVolt

This command sets the voltage slew rate for increasing voltage transitions while in constant voltage regulation. The units for voltage slew rate are volts per millisecond. MAXimum sets the slew to the fastest possible rate. MINimum sets the slew to the slowest rate. Slew rates less than the minimum value are set to MINimum. Slew rate settings less than the minimum value are set to MINimum. Slew rate settings greater than the maximum value are set to MAXimum.

Address 0x5030

Function Code 0x10

Access Write

Register Count 2

Parameters 1 to MAXimum [V/ms] | MAXimum | MINimum

Data Format 32-bit Floating Point Number

Query Address 0x5040

Function Code 0x03

Access Read

Register Count 2

Data Format 32-bit Floating Point Number

10.8.16 RiseRampPwr

This command sets the power slew rate for increasing power transitions while in constant power regulation. The units for power slew rate are watts per millisecond. MAXimum sets the slew to the fastest possible rate. MINimum sets the slew to the slowest rate. Slew rates less than the minimum value are set to MINimum. Slew rate settings less than the minimum value are set to MINimum. Slew rate settings greater than the maximum value are set to MAXimum.

Address 0x5050

Function Code 0x10

Access Write

Register Count 2

Parameters 1 to MAXimum [W/ms] | MAXimum | MINimum

Data Format 32-bit Floating Point Number

Query Address 0x5060

Function Code 0x03

Access Read

Register Count 2

Data Format 32-bit Floating Point Number

10.8.17 FallRampCurr

This command sets the current slew rate for decreasing current transitions while in constant current regulation. MAXimum sets the slew to the fastest possible rate. MINimum sets the slew to the slowest rate. Slew rates less than the minimum value are set to MINimum. Slew rate settings less than the minimum value are set to MINimum. Slew rate settings greater than the maximum value are set to MAXimum.

Address 0x5090

Function Code 0x10

Access Write

Register Count 2

Parameters 1 to MAXimum [A/ms] | MAXimum | MINimum

Data Format 32-bit Floating Point Number

Query Address 0x50A0

Function Code 0x03

Access Read

Register Count 2

Data Format 32-bit Floating Point Number

10.8.18 FallRampVolt

This command sets the voltage slew rate for decreasing voltage transitions while in constant voltage regulation. The units for voltage slew rate are volts per millisecond. MAXimum sets the slew to the fastest possible rate. MINimum sets the slew to the slowest rate. Slew rates less than the minimum value are set to MINimum. Slew rate settings less than the minimum value are set to MINimum. Slew rate settings greater than the maximum value are set to MAXimum.

Address 0x50B0

Function Code 0x10

Access Write

Register Count 2

Parameters 1 to MAXimum [V/ms] | MAXimum | MINimum

Data Format 32-bit Floating Point Number

Query Address 0x50C0

Function Code 0x03

Access Read

Register Count 2

Data Format 32-bit Floating Point Number

10.8.19 FallRampPwr

This command sets the power slew rate for decreasing power transitions while in constant power regulation. The units for power slew rate are watts per millisecond. MAXimum sets the slew to the fastest possible rate. MINimum sets the slew to the slowest rate. Slew rates less than the minimum value are set to MINimum. Slew rate settings less than the minimum value are set to MINimum. Slew rate settings greater than the maximum value are set to MAXimum.

Address 0x50D0

Function Code 0x10

Access Write

Register Count 2

Parameters 1 to MAXimum [W/ms] | MAXimum | MINimum

Data Format 32-bit Floating Point Number

Query Address 0x50E0

Function Code 0x03

Access Read

Register Count 2

Data Format 32-bit Floating Point Number

10.8.20 ControlMode

This command configures the MagnaDC power supply's control mode. *Control Modes* provides more information about the various options.

Address 0x6030

Function Code 0x06

Access Write

Register Count 1

Parameters 1 (CURRENT) | 2 (VOLTAGE) | 3 (POWER) | 4 (RESISTANCE) | 5 (RHEOSTAT) | 6 (SHUNTREG)

Data Format 16-bit Integer

Query Address 0x6040

Function Code 0x03

Access Read

Register Count 1

Data Format 16-bit Integer

10.8.21 FactoryRestore

This command performs a *factory restore* to default EPROM values. Both Soft Restore and Hard Restore are available through command parameters.

Address 0x8010

Function Code 0x06

Access Write

Register Count 1

Parameters 1 (Soft Restore) | 2 (Hard Restore)

Data Format 16-bit Integer

10.8.22 Lock

This command configures the MagnaDC power supply's lock state. While locked, the stop button is the only functional button on the front panel. See *Lock* for more details on how lock works and how behaves relative to other locking inputs (front panel and digital input).

Address 0x8030

Function Code 0x06

Access Write

Register Count 1

Parameters 0 (OFF) | 1 (ON)

Data Format Boolean

Query Address 0x8020

Function Code 0x03

Access Read

Register Count 1

Data Format 16-bit Integer

10.8.23 SenseMode

This command configures where the MagnaDC power supply senses voltage. The sense location also effects how power and resistance are calculated. Local sensing monitors the directly across the output terminals. Remote sensing, as described in *Remote Sense Connection*, measures across the terminal JS2. This external connection can be used to improve regulation at the point of load, as is needed for example, in compensating voltage drops caused by wire resistance.

Address 0x8060

Function Code 0x06

Access Write

Register Count 1

Parameters 0 (local) | 1 (remote)

Data Format 16-bit Integer

Query Address 0x8070

Function Code 0x03

Access Read

Register Count 1

Data Format 16-bit Integer

10.8.24 CommProt

This command changes the command protocol of the MagnaDC power supply.

Address 0x8080

Function Code 0x06

Access Write

Register Count 1

Parameters 0 (SCPI) | 1 (MagnaLINK) | 2 (Modbus) | 3 (Industrial Networks)

Data Format 16-bit Integer

Query Address 0x8090

Function Code 0x03

Access Read

Register Count 1

Data Format 16-bit Integer

10.8.25 SetSource

The command selects and routes different set points sources to the digital controller. Operation of this feature is described in *Set Point Source*. By default, the source is set to *local* (value 0), where set points originating from the front panel or communication interfaces are routed to the SLx Series digital control. When the source is set to *function generator* (value 1), set points are generated internally, by a periodic function generator block. When *external analog input* (value 3) is set, the voltage(s) applied to the rear connector are converted into set points.

Address 0x80A0

Function Code 0x06

Access Write

Register Count 1

Parameters 0 (local) | 1 (function generator) | 2 (external analog input)

Data Format 16-bit Integer

Query Address 0x80B0

Function Code 0x03

Access Read

Register Count 1

Data Format 16-bit Integer

ETHERNET/IP COMMAND SET

11.1 EtherNet/IP Overview

EtherNet/IP is an Ethernet-based communication protocol designed for industrial network communication. EtherNet/IP uses Common Industrial Protocol (CIP) over an Ethernet connection, typically through an RJ-45 connector. EtherNet/IP is widely used, especially in industrial settings, due to its large and fast data exchanges and community of support from [Open DeviceNet Vendors Association \(ODVA\)](#). The following terminology will be used throughout this document:

Device A device is any product that supports the EtherNet/IP protocol.

Connection A connection is a logic link between two devices to send and receive data.

Originator An originator (O) is a master device, or a controlling device, that initiates a request or a connection. PLCs or external software can be used as an EtherNet/IP originator.

Target A target (T) is a device that receives a request or connection from the master. Multiple targets can be connected to one originator on a network. Magna-Power products, that support EtherNet/IP, are target devices.

TCP TCP is a connected communication protocol that has error handling built-in. TCP requires that the originator and target are both connected to each other and will exchange data in a multiple handshake format.

UDP UDP is a communication protocol that does not require a connection. UDP messages are rapidly sent over the network to a specific destination without error handling.

In the EtherNet/IP protocol there are two main types of communication: explicit messaging and implicit messaging. Each type of communication has supports different connections, traffic paths, and message formats, as shown in the chart below.

Table 11.1: Traffic classes

Messaging	Form of messaging	Protocol	Connection
Explicit	Unconnected/Connected	TCP/IP	Class 3
Implicit	Connected	UDP/IP	Class 1

For a more complete overview of EtherNet/IP and underlining standards, visit ODVA.org .

11.1.1 Explicit Messaging

Explicit messaging is used for non-realtime data exchange using request/response unicast messages handled with the TCP/IP protocol. Explicit messages are typically used when the originator device sends a request to read/write a value from/to a specific location on the target device. For example, an originator could send an explicit message to set the device lock status. Requests from an originator always result in a target response to indicate transaction success or failure.

The following parameters are needed in constructing an explicit message:

Service Code/Name The service code or the service name are required for requesting the action for the target device. For Magna-Power devices supporting EtherNet/IP, the service codes that are supported are *Get Attribute Single* (14 or 0x0E) and *Set Attribute Single* (16 or 0x10).

Class ID The class ID specifies the class object that data is being sent to or read from. For Magna-Power devices supporting EtherNet/IP, the class ID should be set to 162 (0xA2).

Instance ID The instance ID specifies the instance number of the above class object that is referenced in the request. All device supported instances can be found in the section *Instances Listing*.

Attribute ID The attribute ID specifies the attribute of the above instance referenced in the request. For Magna-Power devices, the attributes: *Name* (1), *Access* (4), and *Value* (5) are available. In most cases, the attribute ID should be set to 5.

11.1.2 Class 3 Connection

Class 3 connections are made only for explicit messages using TCP/IP. The connection parameters along with support communications paths are listed below. Detailed examples for explicit messages are provided in *Explicit Messaging Example*.

Table 11.2: Class 3 connection parameters

Parameter	Value
Number of Simultaneous Connections	6
Supported RPI (Requested Packet Interval)	100 ms to 10000 ms
T →O Connection Types	Point-to-Point
O →T Connection Types	Point-to-Point
Supported Trigger Types	Application
Max. Supported Connection Size	1526 bytes
Supported Priorities	Low, High

11.1.3 Implicit Messaging

Implicit messaging is used for time-critical data exchange between an originator and uses unicast or multicast messages handled with the UDP/IP protocol. The typical use case is when the originator needs to set or query values on a target(s) in a controlled manner (cyclic and change-of-state).

11.1.4 Class 1 Connection

Implicit messages must define a traffic pathways up front as it does not require responses from targets, which greatly reduces traffic. Connection paths are defined as either *inputs* or *outputs* with respect to the network. Inputs hold data received *from* the network, while outputs are data sent *to* the network. Only a subset of instances in *Instances Listing* can be include as inputs/outputs, which are listed below.

Table 11.3: Supported implicit instances

Name	Instance	Service	Size (Bytes)
<i>StatusRegQ</i>	13	Get	8
<i>MeasCurrQ</i>	257	Get	4
<i>MeasVoltQ</i>	258	Get	4
<i>SetpointCurr</i>	513	Set	4
<i>SetpointVolt</i>	515	Set	4

Below lists the connection parameters for a Class 1 connection. A detailed example of an implicit messages sent cyclically, is provided in *Implicit Messaging Example*.

Table 11.4: Class 1 connection parameters

Parameter	Value
Number of Simultaneous Connections	4
Supported RPI (Requested Packet Interval)	1ms to 3200ms
T→O Connection Types	Point-to-point, Multicast, Null
O→T Connection Types	Point-to-point, Null
Supported Trigger Types	Cyclic, Change-of-State
Max. Supported Input/Output Connection Size	1448 bytes (Large Forward Open) 509 bytes (Forward Open)
Supported Priorities	Low, High, Scheduled, Urgent

The *Electronic Data Sheet* file contains multiple connection types, with *Exclusive-Owner* being the most flexible, since it offers bi-directional traffic. With *Input Only* connections, originator (s) can only hold data and never sends data out onto the network. *Heartbeat* connections, send small messages, over a fixed interval, in a single direction (either O →T or T →O). All the supported connection types are outlined below.

Exclusive-Owner connection This type of connection controls the outputs and does not depend on other connections.

Max. number of Exclusive-Owner connections: 1 Connection path O →T: Assembly Object, instance 0x96 (Default) Connection path T →O: Assembly Object, instance 0x64 (Default)

Input-Only connection This type of connection is used to read data from the target without controlling the outputs. It does not depend on other connections.

Max. number of Input-Only connections: Up to 4 (shared with Exclusive-Owner and Input-Only connections) Connection point O →T: Assembly Object, instance 0x03 (Default) Connection point T →O: Assembly Object, instance 0x64 (Default) Please note that if an Exclusive-Owner connection has been opened towards the module and times out, the Input-Only connection times out as well. If the Exclusive-Owner connection is properly closed, the Input-Only connection remains unaffected.

Input-Only Extended connection This connection's functionality is the same as the standard Input-Only connection. However, when this connection times out it does not affect the state of the application.

Connection point O →T: Assembly Object, instance 0x06 (Default) Connection point T →O: Assembly Object, instance 0x64 (Default)

Listen-Only connection This type of connection requires another connection in order to exist. If that connection (Exclusive-Owner or Input-Only) is closed, the Listen-Only connection will be closed as well.

Max. no. of Input-Only connections: Up to 4 (Shared with Exclusive-Owner and Input-Only connections) Connection point O →T: Assembly Object, instance 0x04 (Default) Connection point T →O: Assembly Object, instance 0x64 (Default)

Listen-Only Extended connection This connection’s functionality is the same as the standard Input-Only connection. However, when this connection times out it does not affect application state.

Connection point O →T: Assembly Object, instance 0x07 (Default) Connection point T →O: Assembly Object, instance 0x64 (Default)

11.1.5 Electronic Data Sheet

When developing or using Ethernet/IP software to talk to a Magna-Power Electronics SLx Series, an electronic data sheet (EDS) should be used for device discovery and network setup. The EDS file is a custom file created by Magna-Power Electronics that describes communication parameters, available services, and device identification. The file may be requested as part of the setup process in PLCs or installing third-party software. The EDS can be downloaded below and is used for *Communication Examples*.

Magna-Power Electronics Electronic Data Sheet

11.1.6 Data Formatting

Byte Ordering EtherNet/IP must exchange properly formatted messages such that the targets can read requests. If the wrong number types or byte orderings are used, targets can misinterpretation data and respond unexpectedly. For example, the data entry for [Hilscher EtherNet/IP Tool](#). For 16-bit words, bytes are ordered such that the significant bytes precedes the lower bytes in memory, which is standard little-endian. For 32-bit values, words are also ordered as little-endian, where the most significant word, precedes the least significant word. For a 32-bit value, *0x12345678*, it should be sent as *0x78563412*. Data is received following the same ordering. How software tools format data varies, and should be explored fully before testing.

Floating Point Data in transferred as a binary numbers (as opposed ASCII in *SCPI Command Set*) and needs a pre-determined format for representing decimal numbers. For this, the widely adopted standard, *IEEE-754*, is used for storing floating point as a 32-bit values. For example, decimal number *3.14* is stored as *0x4048F5C3* in floating point. The number must adhere to the byte ordering conventions described previously. The final value of *3.14* would be sent as *0xC3F54840*. Floating point numbers are received in the same format as they are sent.

11.2 Physical Interface

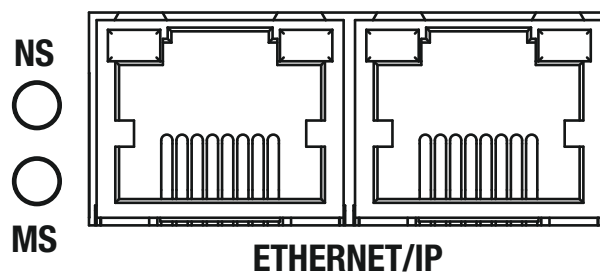

Fig. 11.1: Rear interface

11.2.1 Ethernet Ports

The SLx Series has two 100 Mbps RJ-45 Ethernet ports on the rear of the unit for EtherNet/IP communications, shown in *Rear interface* labeled *ETHERNET/IP*. Either port may be used, with the other port acting as an Ethernet passthrough.

11.2.2 LED Codes

In the rear of the SLx Series is a communications interface with two exposed bi-color LEDs. The LED labeled NS indicates network status and the one labeled MS indicates module status, as shown in *Rear interface*. Status is indicated using colors and blink patterns, as shown in the tables below.

Table 11.5: NS LED States

State	Description
Off	No power or no IP address
Green	Online, one or more connections established (CIP Class 1 or 3)
Green, flashing	Online, no connection established
Red	Duplicate IP address, fatal error
Red, flashing	One or more connections timed out (CIP Class 1 or 3)

Table 11.6: MS LED States

State	Description
Off	No power or no error
Green	Controlled by an Originator in Run state and, if CIP Sync is enabled, time is synchronized to a Grandmaster clock
Green, flashing	Not configured, Originator in Idle state, or if CIP Sync is enabled, time is synchronized with Grandmaster clock
Red	Major fault, (exception state or fatal error)
Red, flashing	Recoverable fault(s). Module is configured, but stored parameters differ from currently used parameters.

The RJ-45 Ethernet ports have two LEDs that indicate the status of the Ethernet connection. Link and activity status are indicated using colors and blink patterns, as shown in the tables below.

Table 11.7: Top-left RJ-45 LED States

State	Description
Off	No link
Green	Ethernet link (100 Mbps) established
Green, flashing	Activity (100 Mbps)

Table 11.8: Top-right RJ-45 LED States

State	Description
Off	No link
Orange	Ethernet link (10 Mbps) established
Orange, flashing	Activity (10 Mbps)

11.3 Diagnostic and Simulation Tools

In this section, tools are discussed for device discovery, configuration, and simulation of EtherNet/IP messages and connection classes on the network. Third-party software is recommended to act as the originator for these messages and is used extensively in later examples.

11.3.1 HMS IPConfig

HMS Networks provides a configuration tool called *HMS IPconfig* that is used to support their industrial communication interfaces. This tool can be used to discover devices on the network, configure IP settings, and blink the device's LEDs for physical identification.

To configure device settings, ensure the SLx Series is connected to the network, open the tool, and select the device from the list of discovered devices. Click on the discovered device to open a configuration window as shown in *HMS IPConfig*. The IP address, subnet mask, gateway, and other network settings can be modified.

The software is available on HMS's website listed below:

HMS IPConfig

11.3.2 EtherNet/IP Web Page

Each Magna-Power EtherNet/IP device hosts a web page for easily accessing local network settings, device parameters, and operation status. The user interface is organized into the side menus listed below.

Overview Shows basic information about the EtherNet/IP module, notably the device uptime.

Parameters Shows the available parameters that can be read or written to. Parameters with a button next to them indicates they are writable from the web interface. Allow time for the parameters to load, as several read and write requests are needed each time new parameters are loaded.

Status Displays the IP settings, Ethernet status, packets sent, and errors encountered. This page is largely for diagnostic purposes.

Configuration This page allows the IP configuration to be modified and saved to the device.

SMTP Not usable menu, feature incompatible with EtherNet/IP implementation.

The web page provides a secondary means of communicating with the device by simplify typing the device's IP address in a web browser, as shown.

There are multiple way the IP address can be found. Navigating in the front panel menu system, *Communication Settings*. Or, using a router to find the assigned IP address by MAC address. Or, installing Ethernet/IP software that support auto-detection, like *HMS IPConfig* or *Hilscher EtherNet/IP Tool*, as shown. Tool is also simulates messages as used in *Communication Examples*.

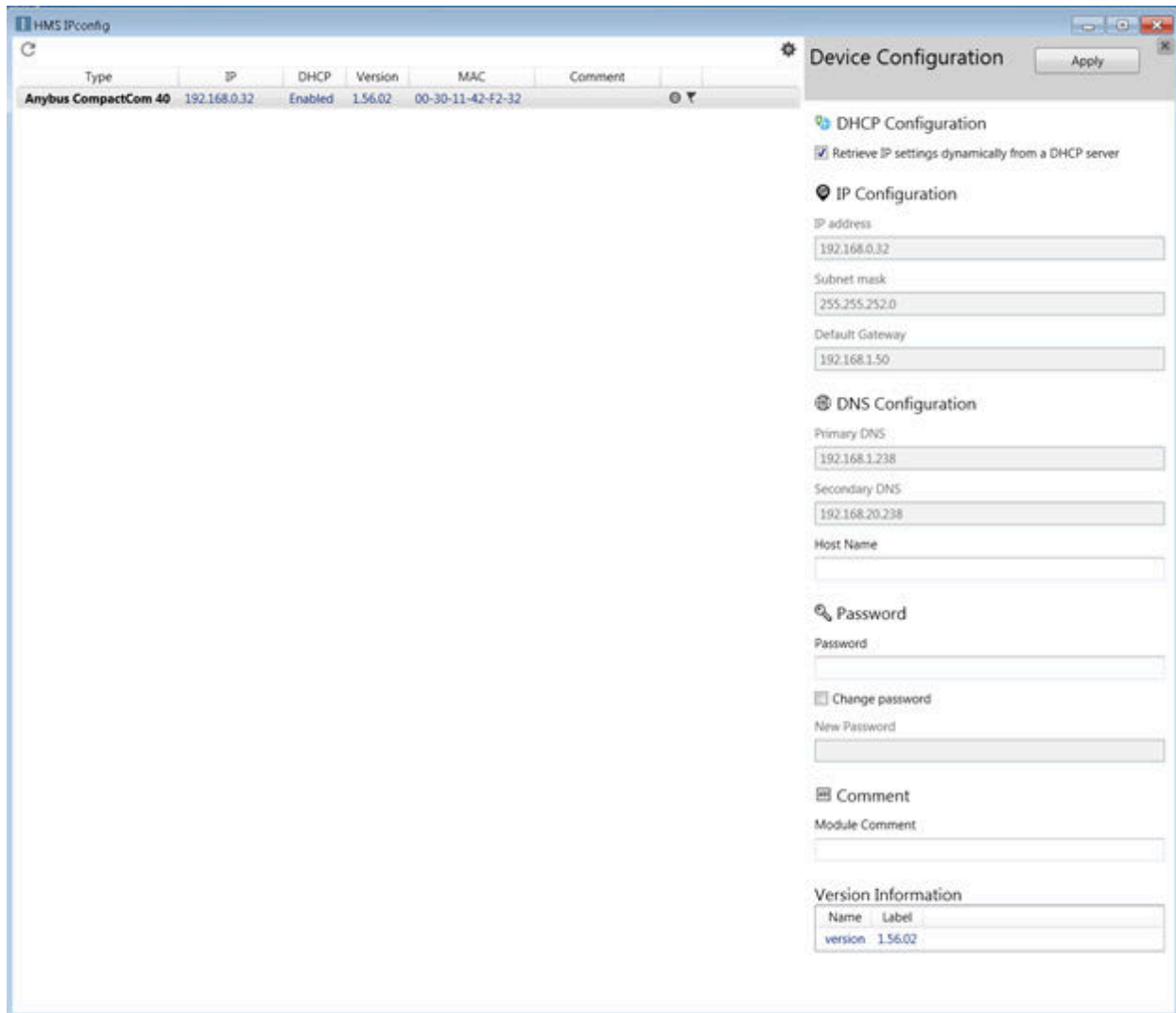

Fig. 11.2: HMS IPConfig

The screenshot displays the EtherNet/IP web interface for a MAGNA-POWER device. The interface is organized into several sections:

- Navigation Menu:** Located on the left, it includes links for MODULE, Overview, Parameters, NETWORK, Status, Configuration, SERVICES, and SMTP.
- Current IP Settings:** A table showing network configuration:

DHCP:	Enabled
IP Address:	192.168.0.103
Subnet Mask:	255.255.252.0
Gateway Address:	192.168.1.50
Host Name:	
Domain name:	magna-power.local
DNS Server #1:	192.168.1.238
DNS Server #2:	192.168.20.238
- Current Ethernet Status:** A table showing port status:

MAC Address:	00:30:11:3A:6E:FD
Port 1:	100 FDX
Port 2:	No Link
- Interface Counters:** A table with a 'Refresh' button showing traffic statistics for Port 1, Port 2, and Internal.

	Port 1	Port 2	Internal
In Octets:	1105943	0	548679
In Ucast Packets:	191	0	189
In NUcast Packets:	8607	0	5390
In Discards:	0	0	0
In Errors:	0	0	0
In Unknown Protos:	0	0	194
Out Octets:	207575	0	208056
Out Ucast Packets:	217	0	220
Out NUcast Packets:	14	0	14
Out Discards:	0	0	0
Out Errors:	0	0	0
- Media Counters:** A section header for media-related statistics, currently collapsed.

Fig. 11.3: EtherNet/IP web interface

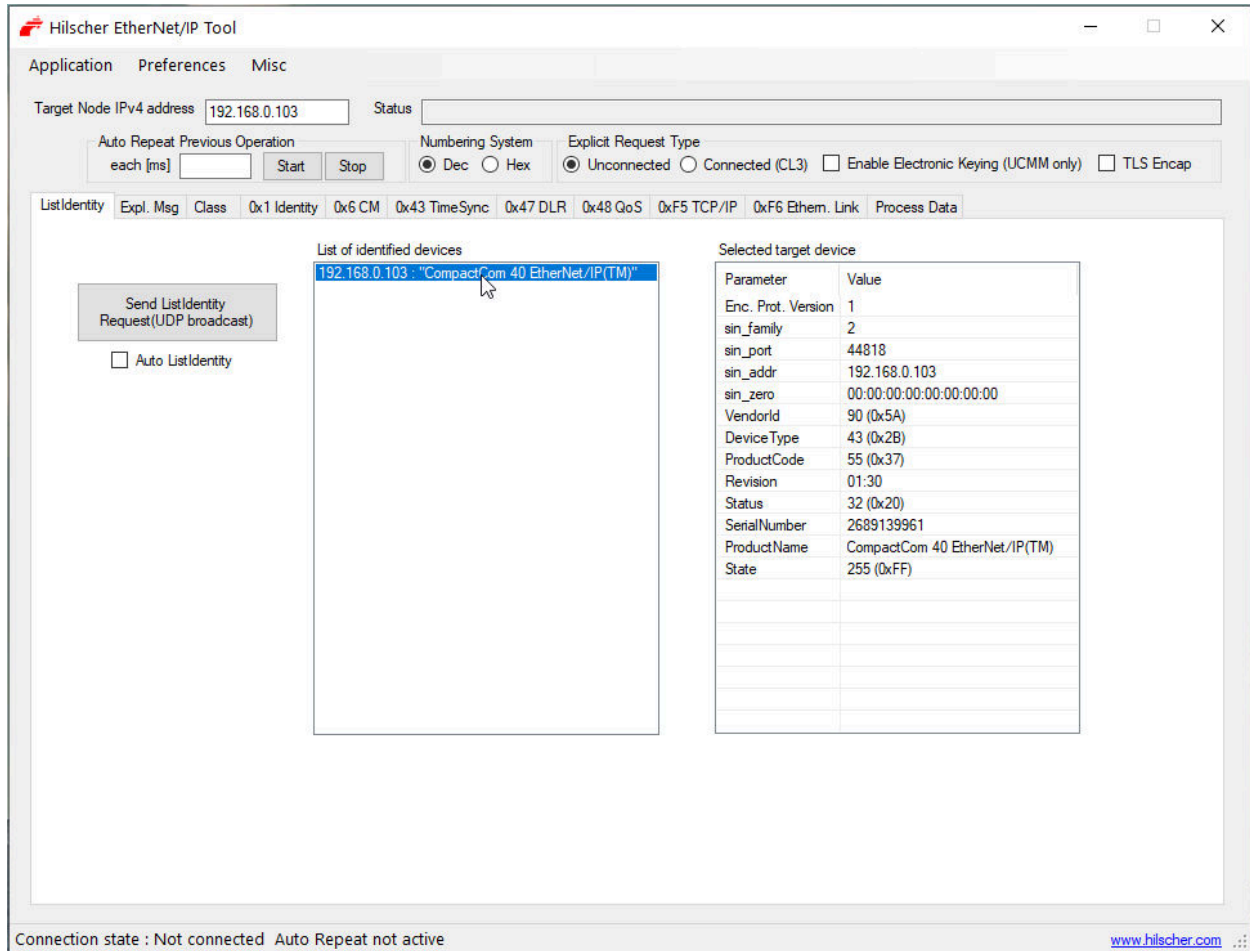

Fig. 11.4: Discovery using Hilscher EtherNet/IP Tool

11.4 Communication Examples

Hilscher's EtherNet/IP Tool is software that can simulate EtherNet/IP messages and send request to Magna-Power devices. Below are some examples using this software to demonstrate the different types of messaging.

11.4.1 Explicit Messaging Example

Explicit messages involve simple request-response traffic between the originator and target. In *Explicit read example*, a request for the *Setpoint Current* (Instance #514) is sent and a response value 2.5A (0x40200000) is returned.

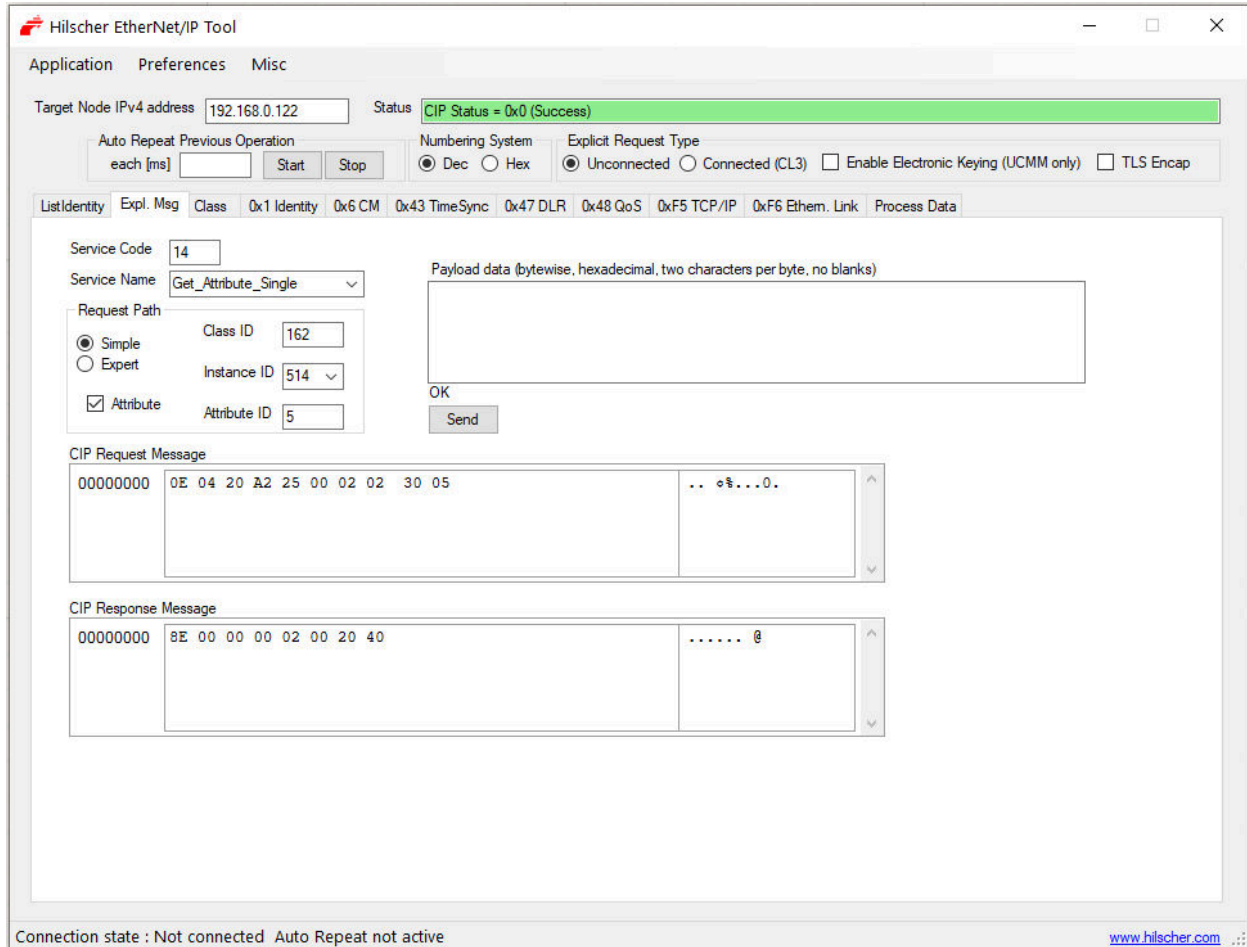

Fig. 11.5: Explicit read example

In *Explicit write example*, the value for the Setpoint Current (Instance #513) is updated with 2.578125A (0x40250000) and a CIP write response acknowledges the operation.

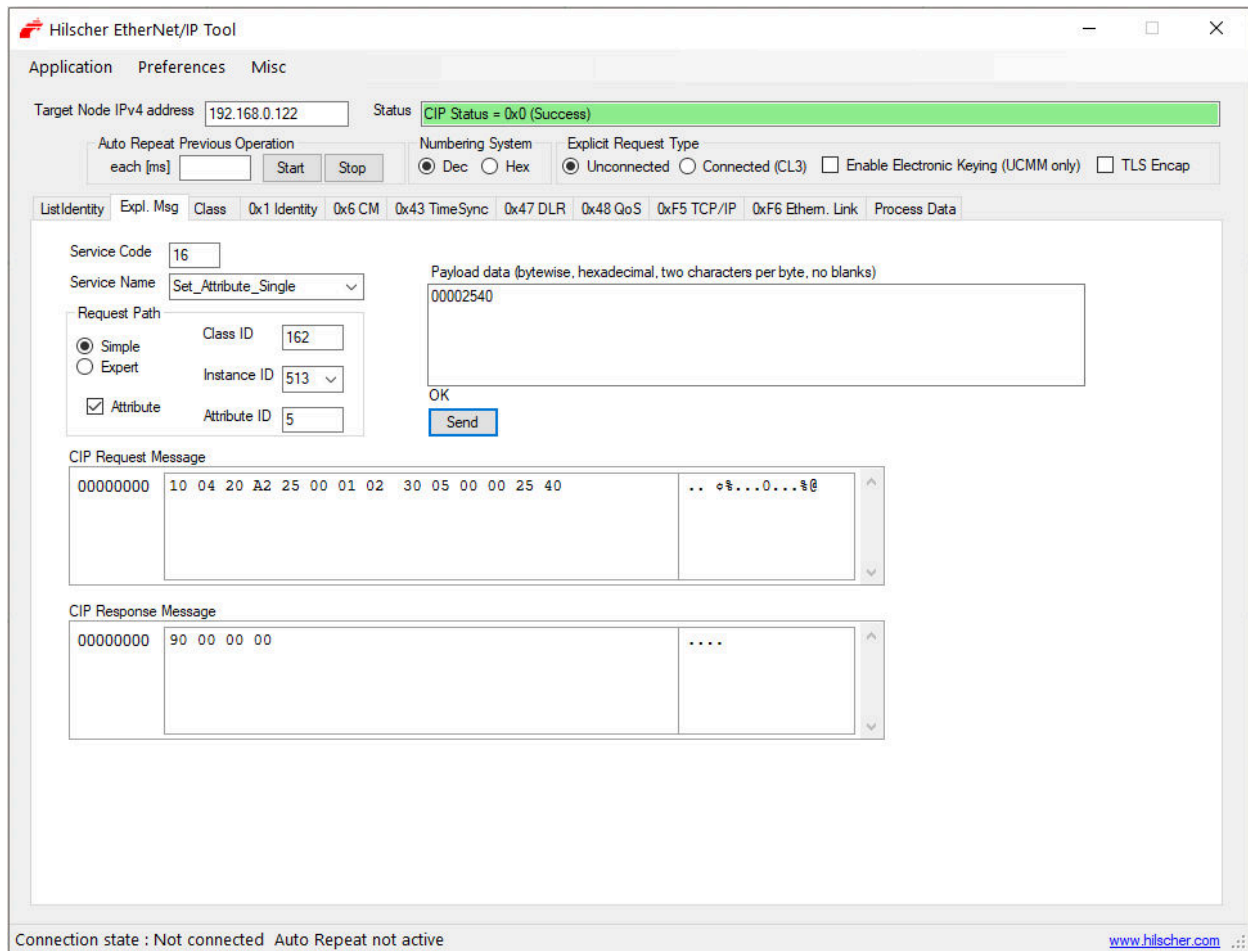

Fig. 11.6: Explicit write example

11.4.2 Implicit Messaging Example

The following is a typical use case example for implicit messaging, where the set point voltage and set point current are cyclically updated, and the terminal voltage, terminal current, and status register are measured concurrently. [Hilscher EtherNet/IP Tool](#) was used to construct the message and to act as the originator. The connection path settings are listed below. Message needs to be formatted as little-endian, as was discussed in [Data Formatting](#). The fields labeled *Actual I/O size* must be sized to fit the traffic and checkboxes *Additional 4 bytes for Run/Idle Header* and *Run Bit Set in Run/Idle Header* must be checked, as shown in [Implicit message example](#).

Table 11.9: Connection path

Object	Instance	Name	Attribute	Supported Services
Assembly (0x04)	100 (0x64)	Input	Data (3) Size (4)	Get Attribute Single (14) Set Attribute Single (16)
	150 (0x96)	Output	Data (3) Size (4)	Get Attribute Single (14) Set Attribute Single (16)
	5 (0x05)	Configuration (Used in Forward Open)	Data (3) Size (4)	Get Attribute Single (14) Set Attribute Single (16)

Table 11.10: Output path, O→T

Name	Value	Data Type	Value (Big-Endian)	Value (Little-Endian)
Setpoint Current	45.0	32 bit Floating Point	0x42340000	0x00003442
Setpoint Voltage	100.0	32 bit Floating Point	0x42C80000	0x0000C842

Table 11.11: Input path, T→O

Name	Value	Data Type	Value (Big-Endian)	Value (Little-Endian)
Status Register	262209	32 bit Integer	0x00040041	0x41000400
Terminal Current Measurement	44.77724	32 bit Floating Point	0x423316F9	0xF9163342
Terminal Voltage Measurement	100.0365	32 bit Floating Point	0x42C812BD	0xBD12C842

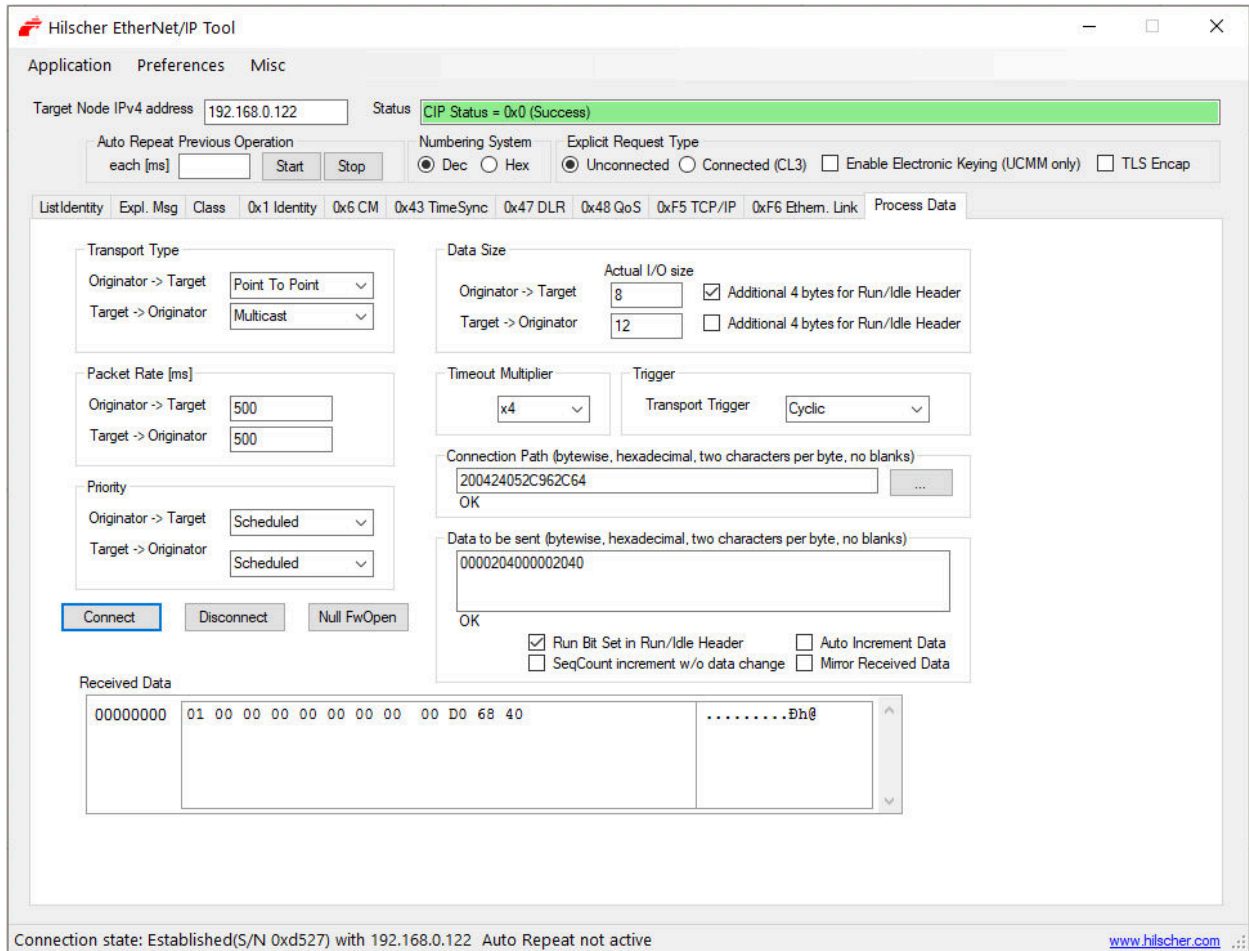

Fig. 11.7: Implicit message example

11.5 Development Using Studio 5000

EtherNet/IP with Magna-Power Electronics products was tested using *Studio 5000 Logix Designer (V35)*, a Rockwell Automation software package for its Allen-Bradley PLCs. The software programs the PLC and requires a separate license. However, trial licenses are available through Rockwell sales channels. More information and programming instructions can be found at [Studio 5000 Logix Designer](#).

11.5.1 Project Configuration

The following steps are needed to create a project in Studio 5000 for EtherNet/IP communication.

1. Download the product description file package located on the Magna-Power Electronics SLx Series page, under [Integrated Options - EtherNet/IP](#) . The file package includes description files for all supported communication protocols across all products. Extract the *.EDS and *.L5X files for the desired product, as they are needed to create a Studio 5000 project.
2. Open Studio 5000 and create a new project from the top menu, *File > New*. Select the PLC model, give the project a name, and then choose a save location. On the next dialog, select the hardware and security settings appropriate for the application, then click the Finish button.
3. Install the product's EDS file from the top menu, *Tools > EDS Hardware Installation Tool*. Click the Next button and follow the prompts to register the device description file that was extracted in Step 1.

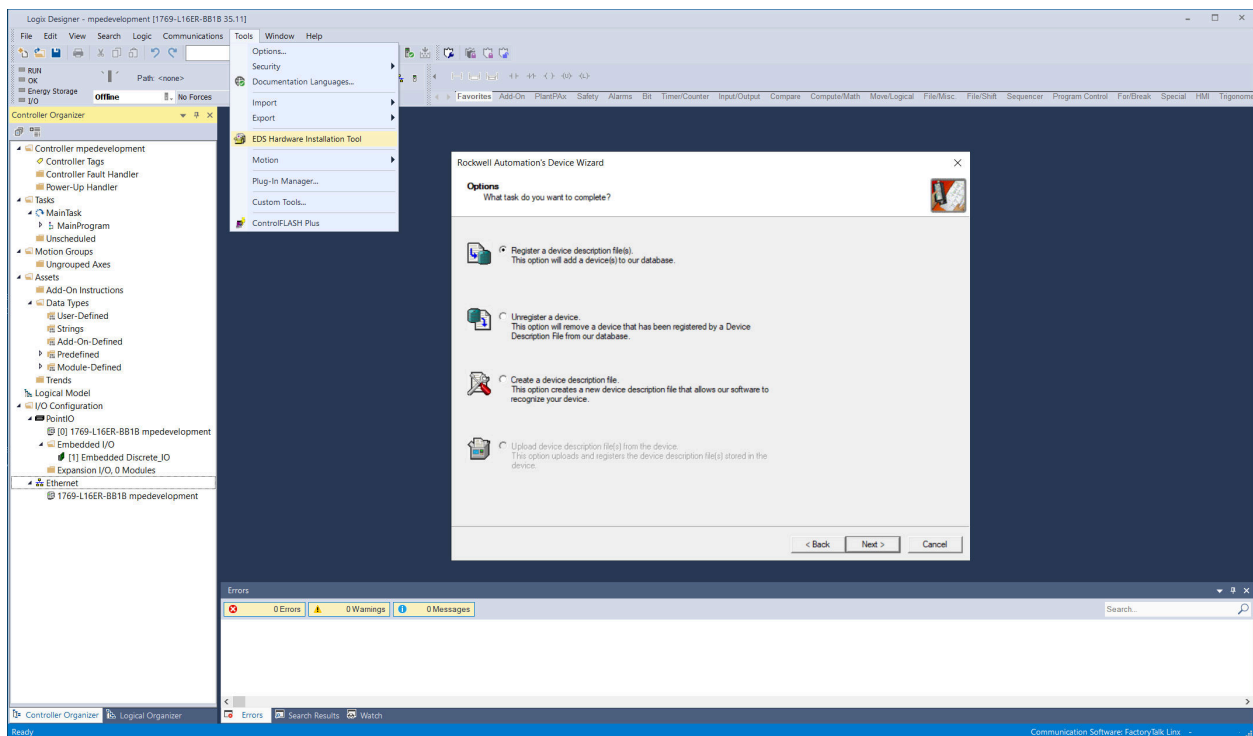

Fig. 11.8: Add a new EDS file

4. Add the device to the project by expanding the I/O configuration tree view in the *Controller Organizer* panel. Right-click the *Ethernet* node and select New Module. From the list of available devices, type “ABCC” in the search box to quickly find the product. Select the product followed by the Create button.

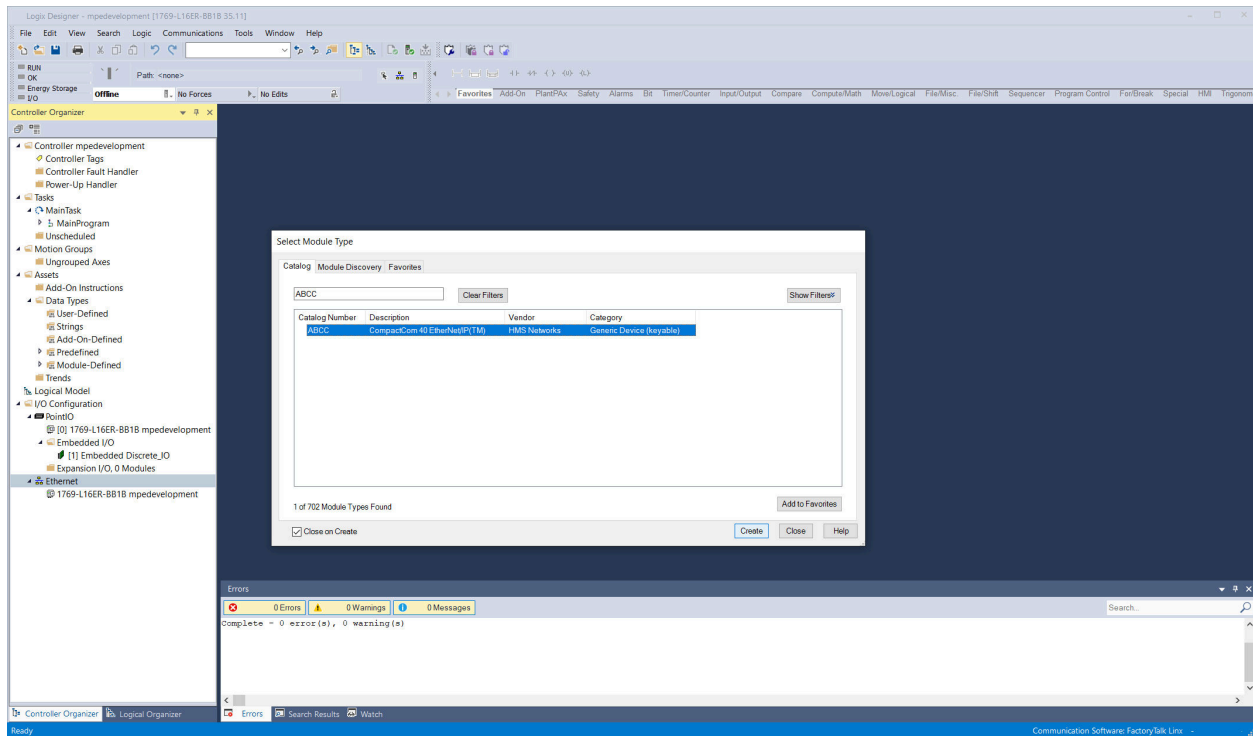

Fig. 11.9: Add new Ethernet-based device

A popup will appear asking for the product details. Give the product a unique name. In the box labeled *IP Address*, enter the IP address given to the SLx Series. The address can be found using a network scanning tool, such as the [HMS IPconfig Tool](#).

Finally, press the Change button at the bottom of the New Module window to open the *Module Definition* dialog. Set the connection data type to SINT. The input size is found by adding the size of the Get services listed in *Supported implicit instances*. Similarly, the output size is found by adding the Set services. Press the OK button to close both dialog boxes and accept the warning regarding changing the module definition.

11.5.2 Implicit Messaging

1. In the *Controller Organizer* panel, expand *Assets > Data Types*, right click on *User-Defined*, and select *Import Data Type*. Select one of the *.L5X files extracted in *Project Configuration - Step 1*. Rename the data type and description, if needed, and press the OK button to close the *Import Configuration* window. Repeat this process for the remaining *.L5X files. Once imported, the assembly object data types are defined. Note that these assembly objects are defined on the SLx Series by the factory and cannot be modified by the user.
2. In the *Controller Organizer* panel, expand *Tasks > MainTask > MainProgram* and double click the *Parameters and Local Tags* entry. As needed, select the desired tag scope, and create one tag per user-defined data type imported in *Implicit Messaging - Step 1*.

Note: Studio 5000 assigns names to tags based on the PLC's perspective. The SLx Series's output is equivalent to PLC's input. Conversely, the SLx Series's input is equivalent to the PLC's output. Tag and data type names are assumed to all

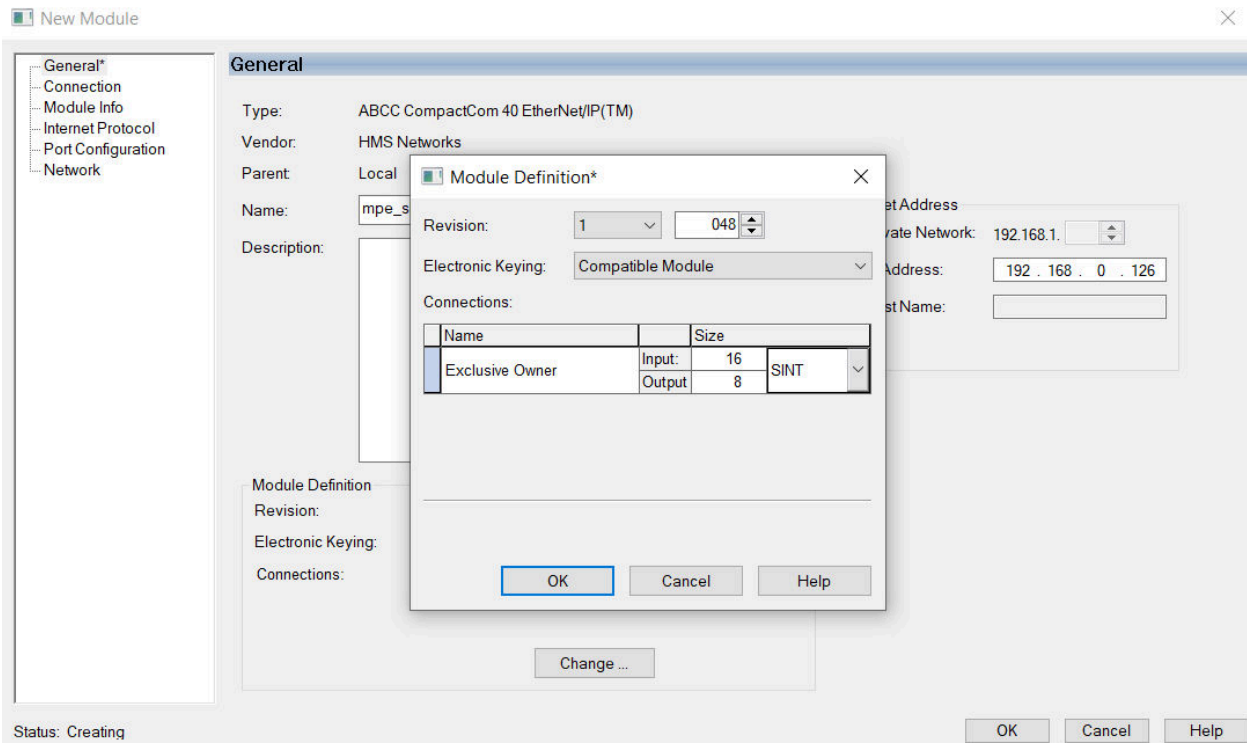

Fig. 11.10: Change the I/O size of the module to match the product

Controller Tags - mpdevelopment(controller)

Scope: mpdevelopment Show: All Tags

Name	Alias For	Base Tag	Data Type	Description	External Access	Constant
Local:1:C			AB:Embedded_Di...		Read/Write	<input type="checkbox"/>
Local:1:I			AB:Embedded_Di...		Read/Write	<input type="checkbox"/>
Local:1:O			AB:Embedded_Di...		Read/Write	<input type="checkbox"/>
mpe_slx_15:I			_005A:ABCC_E44F...		Read/Write	<input type="checkbox"/>
mpe_slx_15:O			_005A:ABCC_DD7...		Read/Write	<input type="checkbox"/>
MPE_Input			MPE_Input	MPE Input Data Type	Read/Write	<input type="checkbox"/>
MPE_Output			MPE_Output	MPE Output Data Type	Read/Write	<input type="checkbox"/>
						<input type="checkbox"/>

Fig. 11.11: Add controller tags for assembly objects

be from the PLC's perspective.

- In the *Controller Organizer* panel, expand *Tasks > MainTask > MainProgram*, and double click the *MainRoutine* entry. Add a synchronous file copy (CPS) block to the ladder diagram. The source should be the SLx Series's input data, and the destination should be the PLC's input data tag. For instance, the source would be *mpe_slx:I.Data[0]* and the destination *MPE_Input*. Repeat the same step with the output data, ensuring that the source is the PLC's output data tag and the destination is the SLx Series's output data. Assembly objects are now defined, and implicit messaging between the PLC and SLx Series is made possible.

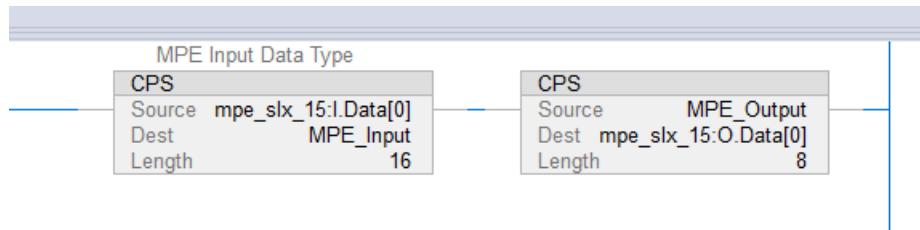

Fig. 11.12: Map assembly object to controller tags using CPS block

11.5.3 Explicit Messaging

- In the *Controller Organizer* panel, expand *Tasks > MainTask > MainProgram* and double click the *Parameters and Local Tags* entry. Create tags for storing explicit messaging data. In this example, tags are created for sending data (Output) and receiving data (OutputQ).

Name	Alias For	Base Tag	Data Type	Description	External Access	Constant	Style
Local:1:C			AB:Embedded_Di...		Read/Write	<input type="checkbox"/>	
Local:1:I			AB:Embedded_Di...		Read/Write	<input type="checkbox"/>	
Local:1:O			AB:Embedded_Di...		Read/Write	<input type="checkbox"/>	
MPE_Input			MPE_Input	MPE Input Data T...	Read/Write	<input type="checkbox"/>	
MPE_Output			MPE_Output	MPE Output Data ...	Read/Write	<input type="checkbox"/>	
mpe_slx_15:I			_005A:ABCC_E44F...		Read/Write	<input type="checkbox"/>	
mpe_slx_15:O			_005A:ABCC_DD7...		Read/Write	<input type="checkbox"/>	
Output			INT		Read/Write	<input type="checkbox"/>	Decimal
OutputMsg			MESSAGE		Read/Write	<input type="checkbox"/>	
OutputQ			INT		Read/Write	<input type="checkbox"/>	Decimal
OutputQMsg			MESSAGE		Read/Write	<input type="checkbox"/>	

Fig. 11.13: Add necessary tags for explicit messages

Message-type tags are also created (OutputMsg and OutputQMsg). Next, create a message (MSG) block in the ladder diagram and enter OutputMsg in the block's control field. Press the "..." button to open the message configuration dialog. Set the message type to CIP Generic, service to Set Attribute Single, class to A2, instance to 15, and attribute to 5. Set the source field to Output. In the Communication tab, press the Browse button and select the SLx Series.

- Repeat Step 8 for the OutputQ message block, changing the service to Get Attribute Single, the instance number to 16, and the destination to OutputQ.

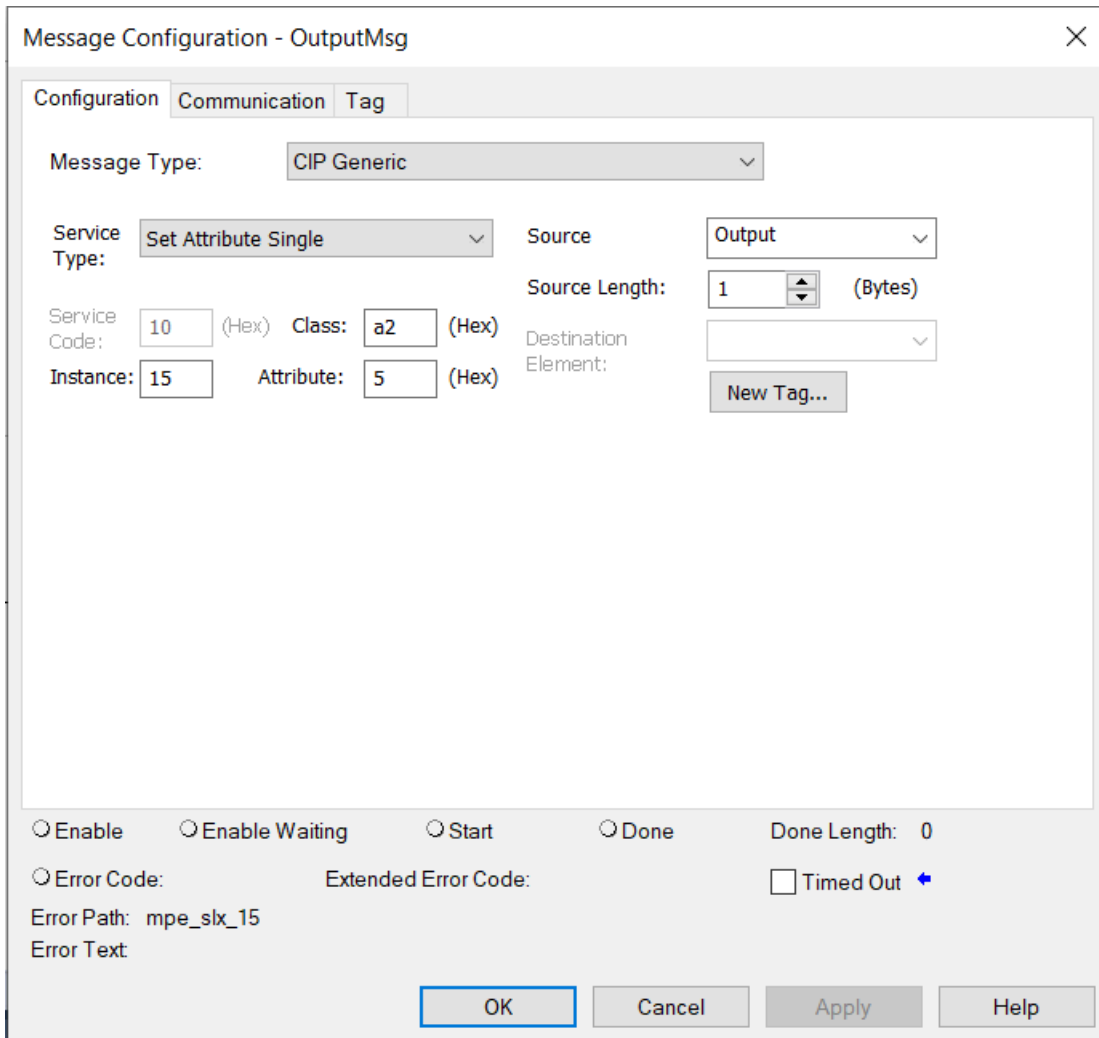

Fig. 11.14: Configure MSG block for explicit messaging

The instance numbers can be found under *Instances Listing*. For example, the instance number to query the power setpoint (SetpointPwr read) is 518.

- Finish adding ladder elements to the program as needed. Once complete, in the top menu navigate to *Communications > Who Active* and find the PLC from the list of discovered devices. Select the Go Online button on the right side of the dialog to connect to the PLC. A popup should appear to download the program to the PLC.

Example ladder diagram shows a basic example of ladder logic used to control the output of an SLx Series using the configured MSG blocks. The MSG blocks are either triggered manually over the network or directly by the user in the Studio 5000 program.

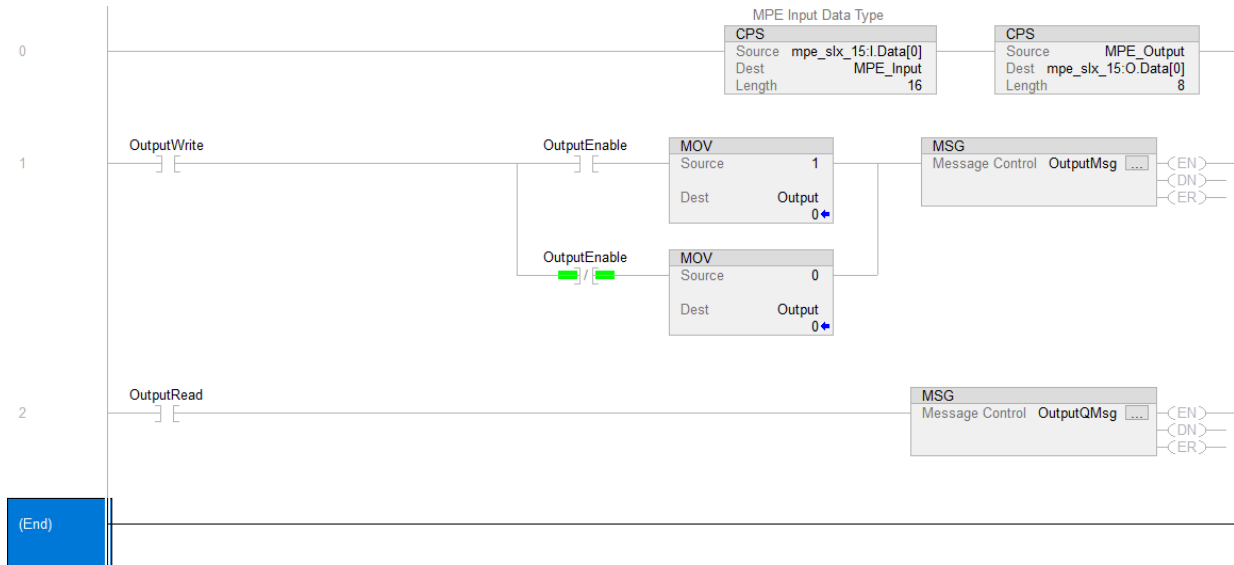

Fig. 11.15: Example ladder diagram

11.6 Instances Listing

EIP Command	Write In-stance	Read In-stance	Description
Operation Commands			
<i>StatusQuesQ</i>	N/A	11	Returns the value of the Questionable Status register
<i>StatusRegQ</i>	N/A	13	Status Register
<i>Output</i>	15	16	
Measurement Commands			
<i>MeasCurrQ</i>	N/A	257	Measures and returns the average current at the sense location
<i>MeasVoltQ</i>	N/A	258	Measures and returns the average voltage at the sense location
<i>MeasPwrQ</i>	N/A	259	Measures and returns the instantaneous DC power at sense location
Setpoint Commands			
<i>SetpointCurr</i>	513	514	Sets the current set-point
<i>SetpointVolt</i>	515	516	Sets the voltage set-point
<i>SetpointPwr</i>	517	518	Sets the power set-point
Trip Commands			
<i>OverTripCurr</i>	769	770	Sets the over current trip (OCT) set-point
<i>OverTripVolt</i>	771	772	Sets the over voltage trip (OVT) set-point
<i>OverTripPwr</i>	773	774	Sets the over power trip (OPT) set-point
<i>UnderTripVolt</i>	775	776	Sets the under voltage trip (UVT) set-point
Slew Commands			
<i>RiseRampCurr</i>	1025	1026	Sets the rising slew rate for current when in current regulation state

continues on next page

Table 11.12 – continued from previous page

EIP Command	Write In-stance	Read In-stance	Description
<i>RiseRampVolt</i>	1027	1028	Sets the rising slew rate for voltage when in voltage regulation state
<i>RiseRampPwr</i>	1029	1030	Sets the rising slew rate for power when in power regulation state
<i>FallRampCurr</i>	1033	1034	Sets the falling slew rate for current when in current regulation state
<i>FallRampVolt</i>	1035	1036	Sets the falling slew rate for voltage when in voltage regulation state
<i>FallRampPwr</i>	1037	1038	Sets the falling slew rate for power when in power regulation
Control Commands			
<i>ControlMode</i>	1283	1284	Sets the control mode
<i>FactoryRestore</i>	1793	N/A	Restores the factory EEPROM data
<i>Lock</i>	1795	1794	Locks and unlocks the product from configuration and set-point changes
<i>SenseMode</i>	1798	1799	Configures the sense location and automated compensation values
<i>CommProt</i>	1800	1801	Changes the communication protocol
<i>SetSource</i>	1802	1803	Sets the setpoint source

11.6.1 Operation Commands

StatusQuesQ

This command queries and returns the values of the Questionable Register. This read-only register holds the live (unlatched) questionable statuses of the MagnaDC power supply. Issuing this query does not clear the register. The bit configuration of the Questionable Register is shown in the table below.

Write Instance 11

Supported Service Get

Register Count 1

Data Format 32-bit Integer

Questionable Register

Bit	Weight	Abbreviation	Description
0	1	OVP	over voltage protection, hard fault
1	2	OCT	over current trip, soft fault
2	4	OVT	over voltage trip, soft fault
3	8	OPT	over power trip, soft fault
4	16	OCP	over current protection, hard fault
5	32	OTP	over temperature protection, hard fault
6	64	RSL	remote sense loss, hard fault
7	128	CC	constant current regulation, regulation status
8	256	CV	constant voltage regulation, regulation status
9	512	CR	constant resistance regulation, regulation status
10	1024	CP	constant power regulation, regulation status
11	2048	SFLT	soft fault, the ord value of all soft faults
12	4096	HFLT	hard fault, the ord value of all hard faults
13	8192	ILOC	interlock open
14	16384	IPL	input power loss fault
15	32768	ADIF	analog or digital input fault

StatusRegQ

This command queries the Status Register. This read-only register holds the live (unlatched) operation status of the MagnaDC power supply. Issuing a query does not clear the register. The register location and definitions are subject to change after any firmware release to accommodate new features. The *Questionable Register* is a subset of the status register and does not change between firmware updates. The present bit assignments are shown in the table below.

Write Instance 13

Supported Service Get

Register Count 2

Data Format 32-bit Integer

Status Register 0

Bit	Name	Description
0	standby	output is in standby
1	live	output is active
2	nonhalt1	available
3	nonhalt2	available
4	overCurrTrip	over current trip
5	overVoltTrip	over voltage trip
6	overPwrTrip	over power trip
7	remoteSenseLoss	remote sense voltage outside of acceptable bounds
8	underVoltTrip	under voltage trip
9	shutdown	target is creating a shutdown condition
10	linPwrLim	power across linear modules exceed ratings
11	resPwrLim	power across resistors exceed ratings
12	bootFailure	one or multiple target did not boot up
13	bootState	one or more targets are waiting to boot
14	phaseCurr	rated phase current exceeded
15	comm	communications are corrupted

continues on next page

Table 11.13 – continued from previous page

Bit	Name	Description
16	overCurrProtect	terminal current exceeded product rating
17	overVoltProtect	terminal voltage exceeded product rating
18	tempRLin	linear module exceeded temperature
19	blownFuse	fuse is blown on the auxiliary power supply
20	interlock	interlock open
21	haltUserClear	available
22	maintenance	maintenance
23	tempDMod	diode modules exceeded temperature
24	incompatibleSysConfig	incompatible system configuration
25	stackOverflow	exceeded firmware stack
26	lineFault	line fault analog/digital inputs
27	tempRMod	resistor module exceeded temperature
28	belowRatedMinVolt	below minimum voltage rating(28)
29	outOfRegulation	out of regulation, unexpected currents measured
30	targetUpgrade	mainctrl upgrading other targets
31	haltSelfClear	available

Status Register 1

Bit	Name	Description
0	phaseLoss	one or more phase missing
1	blownFuseInput	input fuse blown on fuse/emi filter
2	fanLockedRotor	one or more fan's rotor has locked
3	notUsed29	available
4	tempPwrMod	power processing module temperature fault
5	tempOutputMod	output filter module temperature fault
6	tempOutputCap	output capacitors temperature fault
7	tempTransformer	transformer exceeded temperature fault
8	notUsed26	available
9	notUsed27	available
10	notUsed28	available
11	notUsed1	available
12	notUsed2	available
13	notUsed3	available
14	notUsed4	available
15	notUsed5	available
16	invalidSysRating	invalid system rating
17	fwVersConflict	firmware version conflict
18	notUsed8	available
19	notUsed9	available
20	notUsed10	available
21	notUsed11	available
22	notUsed12	available
23	notUsed13	available
24	notUsed14	available
25	notUsed15	available
26	notUsed16	available
27	notUsed17	available
28	notUsed18	available

continues on next page

Table 11.14 – continued from previous page

Bit	Name	Description
29	notUsed19	available
30	notUsed20	available
31	notUsed21	available

Output

This command enables or disables the MagnaDC power supply output. A *1* indicates the product's power processing circuit is active and processing power, while a *0* indicates the power supply is in standby or faulted state.

Write Instance 15

Supported Service Set

Register Count 1

Data Format Boolean

Read Instance 16

Supported Service Get

Register Count 1

Data Format Boolean

11.6.2 Measurement Commands

MeasCurrQ

This query commands the MagnaDC power supply to measure and return the average current through the DC terminals.

Write Instance 257

Supported Service Get

Register Count 1

Data Format 32-bit Floating Point Number

MeasVoltQ

This query commands the MagnaDC power supply to measure and return the average voltage at the DC terminals. If the remote sense function is used and engaged, this command returns the voltage measured at the sense terminals.

Write Instance 258

Supported Service Get

Register Count 1

Data Format 32-bit Floating Point Number

MeasPwrQ

This query commands commands the MagnaDC power supply to measure and return the average power at the DC terminals.

Write Instance 259

Supported Service Get

Register Count 1

Data Format 32-bit Floating Point Number

11.6.3 Setpoint Commands

SetpointCurr

This command programs the current set-point that the MagnaDC power supply will regulate to when operating in constant current mode.

Write Instance 513

Supported Service Set

Register Count 1

Data Format 32-bit Floating Point Number

Read Instance 514

Supported Service Get

Register Count 1

Data Format 32-bit Floating Point Number

SetpointVolt

This command programs the voltage set-point, in volts, which the MagnaDC power supply will regulate to when operating in constant voltage mode.

Write Instance 515

Supported Service Set

Register Count 1

Data Format 32-bit Floating Point Number

Read Instance 516

Supported Service Get

Register Count 1

Data Format 32-bit Floating Point Number

SetpointPwr

This command programs the power set-point, in watts, which the MagnaDC power supply will regulate to when operating in constant power mode.

Write Instance 517

Supported Service Set

Register Count 1

Data Format 32-bit Floating Point Number

Read Instance 518

Supported Service Get

Register Count 1

Data Format 32-bit Floating Point Number

11.6.4 Trip Commands

OverTripCurr

This command programs the over current trip (OCT) set-point. If the input current exceeds the over current trip set-point for multiple samples, the input is disconnected and an OCT fault is indicated.

Write Instance 769

Supported Service Set

Register Count 1

Data Format 32-bit Floating Point Number

Read Instance 770

Supported Service Get

Register Count 1

Data Format 32-bit Floating Point Number

OverTripVolt

This command programs the over voltage trip (OVT) set-point. If the input voltage exceeds the over voltage trip set-point for multiple samples, the input is disconnected and an OVT fault is indicated.

Write Instance 771

Supported Service Set

Register Count 1

Data Format 32-bit Floating Point Number

Read Instance 772

Supported Service Get

Register Count 1

Data Format 32-bit Floating Point Number

OverTripPwr

This command programs the over power trip (OPT) set-point. If the input power exceeds the over power trip set-point for multiple sample, the input is disconnected and an OPT fault is indicated.

Write Instance 773

Supported Service Set

Register Count 1

Data Format 32-bit Floating Point Number

Read Instance 774

Supported Service Get

Register Count 1

Data Format 32-bit Floating Point Number

UnderTripVolt

This command programs the under voltage trip (UVT) set-point. If the input voltage falls below the under voltage trip set-point for multiple samples, the input is disconnected and an UVT fault is indicated.

Write Instance 775

Supported Service Set

Register Count 1

Data Format 32-bit Floating Point Number

Read Instance 776

Supported Service Get

Register Count 1

Data Format 32-bit Floating Point Number

11.6.5 Slew Commands

RiseRampCurr

This command sets the current slew rate for increasing current transitions while in constant current regulation. MAXimum sets the slew to the fastest possible rate. MINimum sets the slew to the slowest rate. Slew rates less than the minimum value are set to MINimum. Slew rate settings less than the minimum value are set to MINimum. Slew rate settings greater than the maximum value are set to MAXimum.

Write Instance 1025

Supported Service Set

Register Count 1

Data Format 32-bit Floating Point Number

Read Instance 1026

Supported Service Get

Register Count 1

Data Format 32-bit Floating Point Number

RiseRampVolt

This command sets the voltage slew rate for increasing voltage transitions while in constant voltage regulation. The units for voltage slew rate are volts per millisecond. MAXimum sets the slew to the fastest possible rate. MINimum sets the slew to the slowest rate. Slew rates less than the minimum value are set to MINimum. Slew rate settings less than the minimum value are set to MINimum. Slew rate settings greater than the maximum value are set to MAXimum.

Write Instance 1027

Supported Service Set

Register Count 1

Data Format 32-bit Floating Point Number

Read Instance 1028

Supported Service Get

Register Count 1

Data Format 32-bit Floating Point Number

RiseRampPwr

This command sets the power slew rate for increasing power transitions while in constant power regulation. The units for power slew rate are watts per millisecond. MAXimum sets the slew to the fastest possible rate. MINimum sets the slew to the slowest rate. Slew rates less than the minimum value are set to MINimum. Slew rate settings less than the minimum value are set to MINimum. Slew rate settings greater than the maximum value are set to MAXimum.

Write Instance 1029

Supported Service Set

Register Count 1

Data Format 32-bit Floating Point Number

Read Instance 1030

Supported Service Get

Register Count 1

Data Format 32-bit Floating Point Number

FallRampCurr

This command sets the current slew rate for decreasing current transitions while in constant current regulation. MAXimum sets the slew to the fastest possible rate. MINimum sets the slew to the slowest rate. Slew rates less than the minimum value are set to MINimum. Slew rate settings less than the minimum value are set to MINimum. Slew rate settings greater than the maximum value are set to MAXimum.

Write Instance 1033

Supported Service Set

Register Count 1

Data Format 32-bit Floating Point Number

Read Instance 1034

Supported Service Get

Register Count 1

Data Format 32-bit Floating Point Number

FallRampVolt

This command sets the voltage slew rate for decreasing voltage transitions while in constant voltage regulation. The units for voltage slew rate are volts per millisecond. MAXimum sets the slew to the fastest possible rate. MINimum sets the slew to the slowest rate. Slew rates less than the minimum value are set to MINimum. Slew rate settings less than the minimum value are set to MINimum. Slew rate settings greater than the maximum value are set to MAXimum.

Write Instance 1035

Supported Service Set

Register Count 1

Data Format 32-bit Floating Point Number

Read Instance 1036

Supported Service Get

Register Count 1

Data Format 32-bit Floating Point Number

FallRampPwr

This command sets the power slew rate for decreasing power transitions while in constant power regulation. The units for power slew rate are watts per millisecond. MAXimum sets the slew to the fastest possible rate. MINimum sets the slew to the slowest rate. Slew rates less than the minimum value are set to MINimum. Slew rate settings less than the minimum value are set to MINimum. Slew rate settings greater than the maximum value are set to MAXimum.

Write Instance 1037

Supported Service Set

Register Count 1

Data Format 32-bit Floating Point Number

Read Instance 1038

Supported Service Get

Register Count 1

Data Format 32-bit Floating Point Number

11.6.6 Control Commands

ControlMode

This command configures the MagnaDC power supply's control mode. *Control Modes* provides more information about the various options.

Write Instance 1283

Supported Service Set

Register Count 1

Data Format 16-bit Integer

Read Instance 1284

Supported Service Get

Register Count 1

Data Format 16-bit Integer

FactoryRestore

This command performs a *factory restore* to default EPROM values. Both Soft Restore and Hard Restore are available through command parameters.

Write Instance 1793

Supported Service Set

Register Count 1

Data Format 16-bit Integer

Lock

This command configures the MagnaDC power supply's lock state. While locked, the stop button is the only functional button on the front panel. See *Lock* for more details on how lock works and how behaves relative to other locking inputs (front panel and digital input).

Write Instance 1795

Supported Service Set

Register Count 1

Data Format Boolean

Read Instance 1794

Supported Service Get

Register Count 1

Data Format Boolean

SenseMode

This command configures where the MagnaDC power supply senses voltage. The sense location also effects how power and resistance are calculated. Local sensing monitors the directly across the output terminals. Remote sensing, as described in *Remote Sense Connection*, measures across the terminal JS2. This external connection can be used to improve regulation at the point of load, as is needed for example, in compensating voltage drops caused by wire resistance.

Write Instance 1798

Supported Service Set

Register Count 1

Data Format 16-bit Integer

Read Instance 1799

Supported Service Get

Register Count 1

Data Format 16-bit Integer

CommProt

This command changes the command protocol of the MagnaDC power supply.

Write Instance 1800

Supported Service Set

Register Count 1

Data Format 16-bit Integer

Read Instance 1801

Supported Service Get

Register Count 1

Data Format 16-bit Integer

SetSource

The command selects and routes different set points sources to the digital controller. Operation of this feature is described in *Set Point Source*. By default, the source is set to *local* (value 0), where set points originating from the front panel or communication interfaces are routed to the SLx Series digital control. When the source is set to *function generator* (value 1), set points are generated internally, by a periodic function generator block. When *external analog input* (value 3) is set, the voltage(s) applied to the rear connector are converted into set points.

Write Instance 1802

Supported Service Set

Register Count 1

Data Format 16-bit Integer

Read Instance 1803

Supported Service Get

Register Count 1

Data Format 16-bit Integer

ETHERCAT COMMAND SET

12.1 EtherCAT Overview

EtherCAT is a real-time Ethernet network protocol developed by Beckhoff Automation for communicating among multiple nodes. EtherCAT networks are formed using CAT5e cabling, where master and nodes can be directly wired together through RJ-45 ports, in a daisy chain configuration, without need for external networking switches.

Software generates master/slave configurations by loading a EtherCAT Slave Information (ESI) file. Magna-Power Electronics provides this ESI file (XML) to customers which contains identifying information, exposes functionality, and stores settings.

Magna-Power Electronics has implemented and tested the basic EtherCAT protocol and Ethernet over EtherCAT. Additional protocols over EtherCAT (e.g., CANopen over EtherCAT (CoE), File Access over EtherCAT) may work, but have not been tested, and therefore are not supported.

12.2 Physical Interface

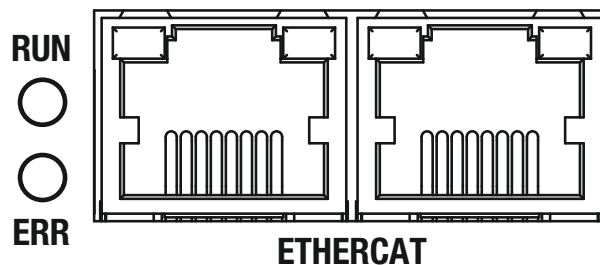

Fig. 12.1: Rear interface

12.2.1 Ethernet Ports

The SLx Series has two RJ-45 Ethernet ports on the rear of the unit for EtherCAT communications, shown in *Rear interface* labeled *ETHERCAT*. Either port may be used, with the other port acting as a passthrough for other EtherCAT devices.

12.2.2 LED Codes

In the rear of the SLx Series is a communications interface with two exposed bi-color LEDs. The LED labeled RUN indicates status of the EtherCAT device and the one labeled ERR indicates EtherCAT communication errors, as shown in *Rear interface*. Status is indicated using colors and blink patterns, as shown in the tables below.

Table 12.1: RUN LED States

State	Description
Off	No power or initializing
Green	Online, operational state
Green, flashing	Online, pre-operational state
Green, 1 flash	Online, safe-operational state
Red	Fatal error

Table 12.2: ERR LED States

State	Description
Off	No power or no error
Red, flashing	Invalid configuration
Red, 1 flash	Unsolicited state change
Red, 2 flashes	Sync manager watchdog timeout
Red	Application controller failure

The RJ-45 Ethernet port has one LED that indicates the status of the Ethernet connection. Link and activity status is indicated using and blink patterns, as shown in the table below.

Table 12.3: Top-left RJ-45 LED States

State	Description
Off	No link
Green	Link sensed, no activity detected
Green, flashing	Link sensed, activity detected

12.3 Data Objects

12.3.1 Process Data Objects (PDOs)

PDOs are real-time data frequently sent to and from connected Magna-Power Electronics devices. When describing PDO traffic, it is referenced with respect to the EtherCAT slave device. For example, *Transmit PDOs* (TxPDO) are transmitted from the slave and are read-only, while *Receive PDOs* (RxPDO) transmits variables to the slave and have write access. Measurement reads would be mapped in the TxPDO Mapping, whereas set points would be in the RxPDO Mapping.

12.3.2 Service Data Objects (SDOs)

SDOs are messages sent on request and have no timing expectations. SDOs are intended for non-real-time communications, as they must wait for the network to respond, and are typically used for reporting status, changing operating modes, and etc. RxSDOs variables should not be used to update values already part of a PDO, as they are updated regularly, and the values would be overwritten by the RxPDO.

12.4 EtherCAT State Machine

The master controls slaves by following the EtherCAT state machine. Slaves can transition between four states: Init, Pre-Operational, Safe-Operational, Operational. In each state configuration checks are made and types of communications opened. The transition between states are diagramed in *EtherCAT state machine*. Allowed communications in each is described in *Allowed protocols for each state*. Devices enter the Init when first switched-on and reaches Operational under normal conditions

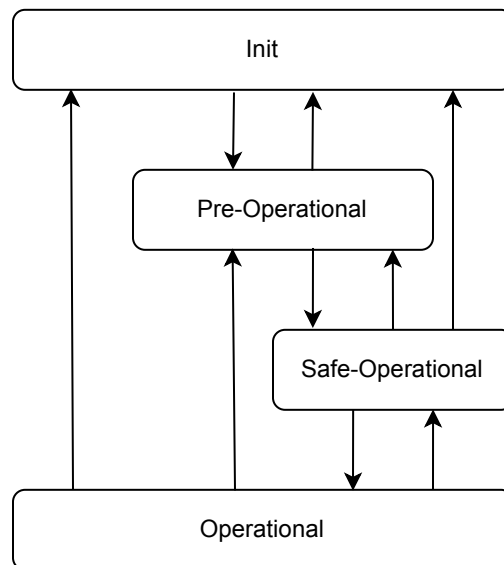

Fig. 12.2: EtherCAT state machine

Table 12.4: Allowed protocols for each state

State	RxSDO/TxSDO	TxPDO	RxPDO
Init			
Pre-Operational	✓		
Safe-Operational	✓	✓	
Operational	✓	✓	✓

12.5 Development using TwinCAT

Communication was tested with Magna-Power Electronics devices using software called TwinCAT 3 (version 3.1), which enables a personal computer to communicate over EtherCAT and act as a PLC master. Software is available for download on the Beckhoff Automation website using the link.

TwinCAT 3

A dedicated EtherCAT network is needed, segregated from the local TCP/IP network, as the two protocols are not compatible. In the examples, a separate network interface card (NIC) was installed just for EtherCAT communications. Specifically, an INTEL 8255x based NIC, as recommended by Beckhoff for real-time communications and compatibility with TwinCAT 3 software.

After installing the NIC and TwinCAT 3 follow the Windows driver [installation guide](#) on the Beckhoff website so that NIC is treated as a TwinCAT network adapter.

12.5.1 Project Configuration

A project file stores connection settings for each EtherCAT device which helps with application development for multi-device networks. The following steps walks through creating a project — the same used in the examples section.

1. Open the TwinCAT XAE Shell (TcXaeShell) application and create a new project by clicking *File > New > Project* and select *TwinCAT XAE Project (XML format)*.
2. Download the Magna-Power Electronics ESI file below, save to the TwinCAT installation directory (default is C:/TwinCAT/3.1/Config/IO/EtherCAT).

Magna-Power Electronics ESI File

3. The *Restart TwinCAT (Config Mode)*, *Toggle Free Run State*, and *Show Online Data* buttons should all be pressed, as shown in Fig. 12.3.

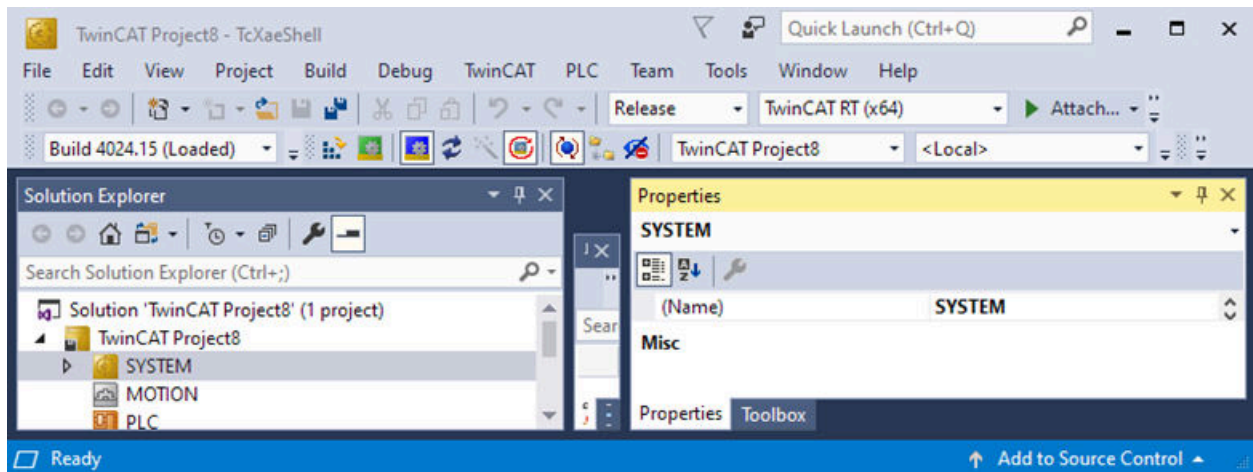

Fig. 12.3: Project running configuration

4. Navigate from the top to *TwinCAT > Show Realtime Ethernet Compatible Devices*. There are three possible scenarios:
 - a. If a TwinCAT adapter was already installed, it will appear under *Installed and ready to use devices(realtime capable)* tree. No additional setup is needed, as shown.

- b. If a TwinCAT adapter is available but not installed, it will appear under *Compatible devices* tree. Select the desired network adapter and press the *Install* button, which makes it appear in *Installed and ready to use devices(realtime capable)* tree.
- c. If a TwinCAT adapter is unavailable the *Compatible devices* tree will be empty, which indicates computer was unable to detect a compatible NIC.

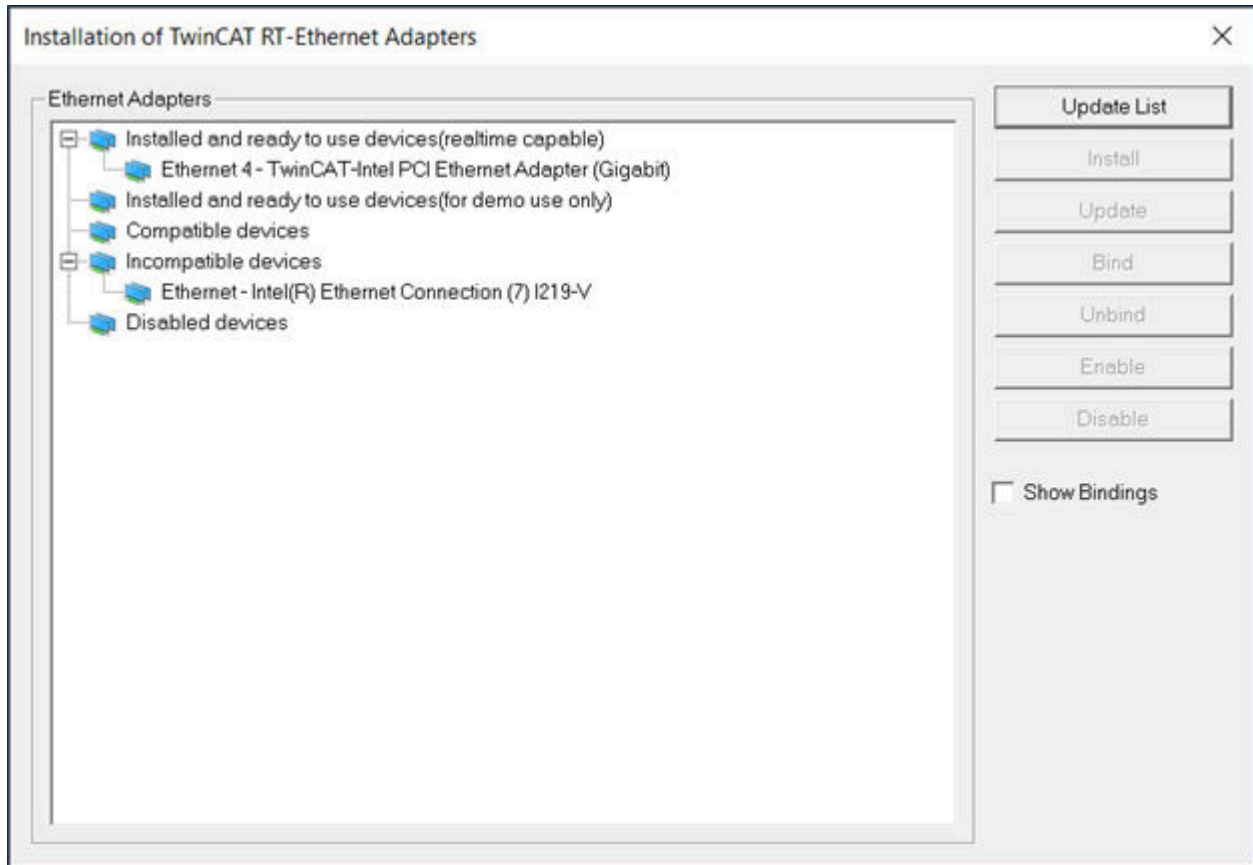

Fig. 12.4: Adapter installation

5. In the *Solution Explorer* panel expand the *I/O* in the project tree. Right click on *Devices* and select *Add New Item*.
6. In the *Insert Device* window, select *EtherCAT Master*.
7. Under the devices tree *Device 1 (EtherCAT)* should be visible. Right click on the device and select *Scan*. If the Magna-Power Electronics device is found, called *Box 1 (Anybus CompactCom 40 EtherCAT)* will be added as a BLANK to Device
8. Verify device configuration by double clicking on *Box 1* and selecting the *Online* tab. If successful, the field labeled *Current State* will show *OP*, indicating the *Operational* state.

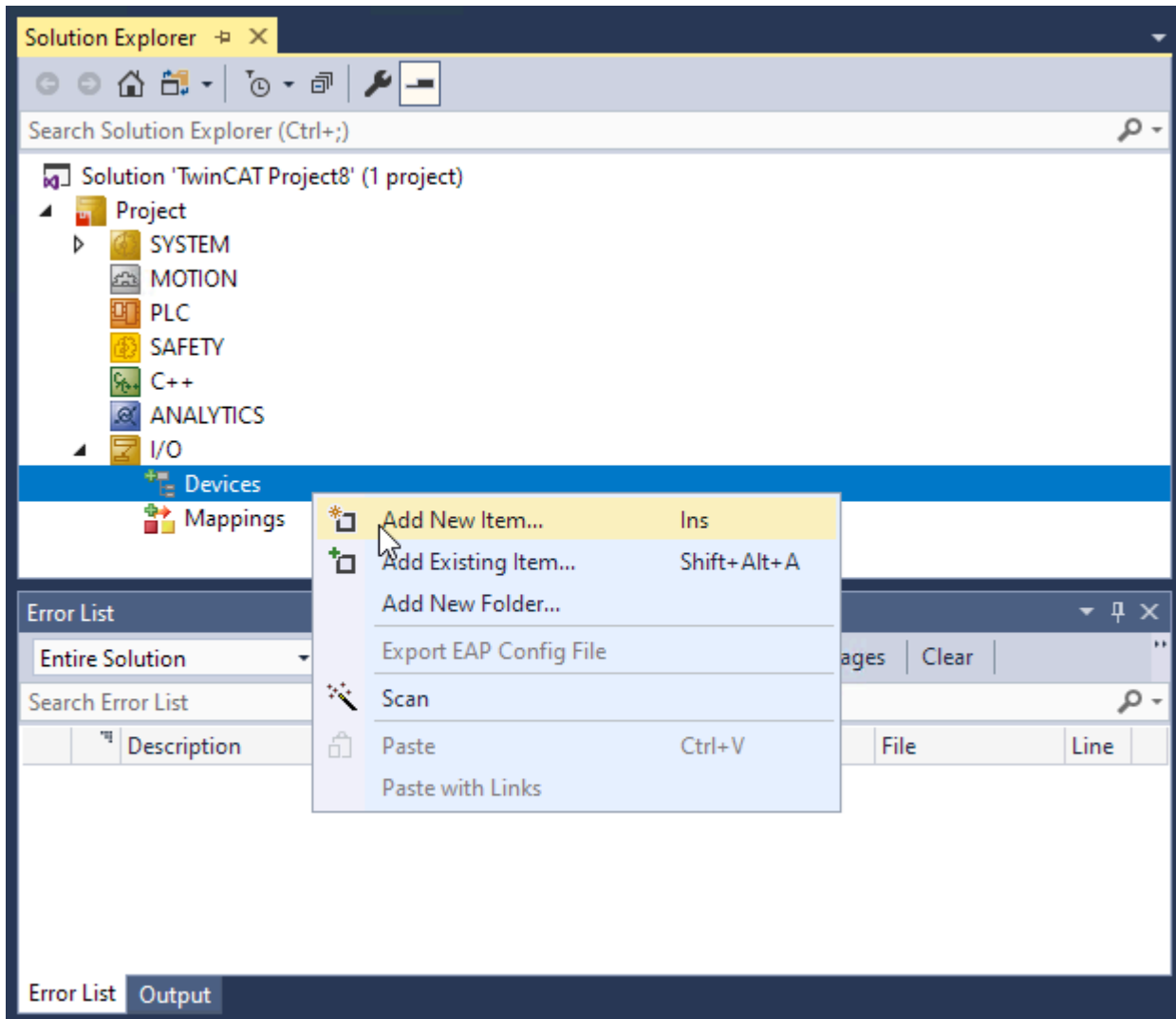

Fig. 12.5: Add new device

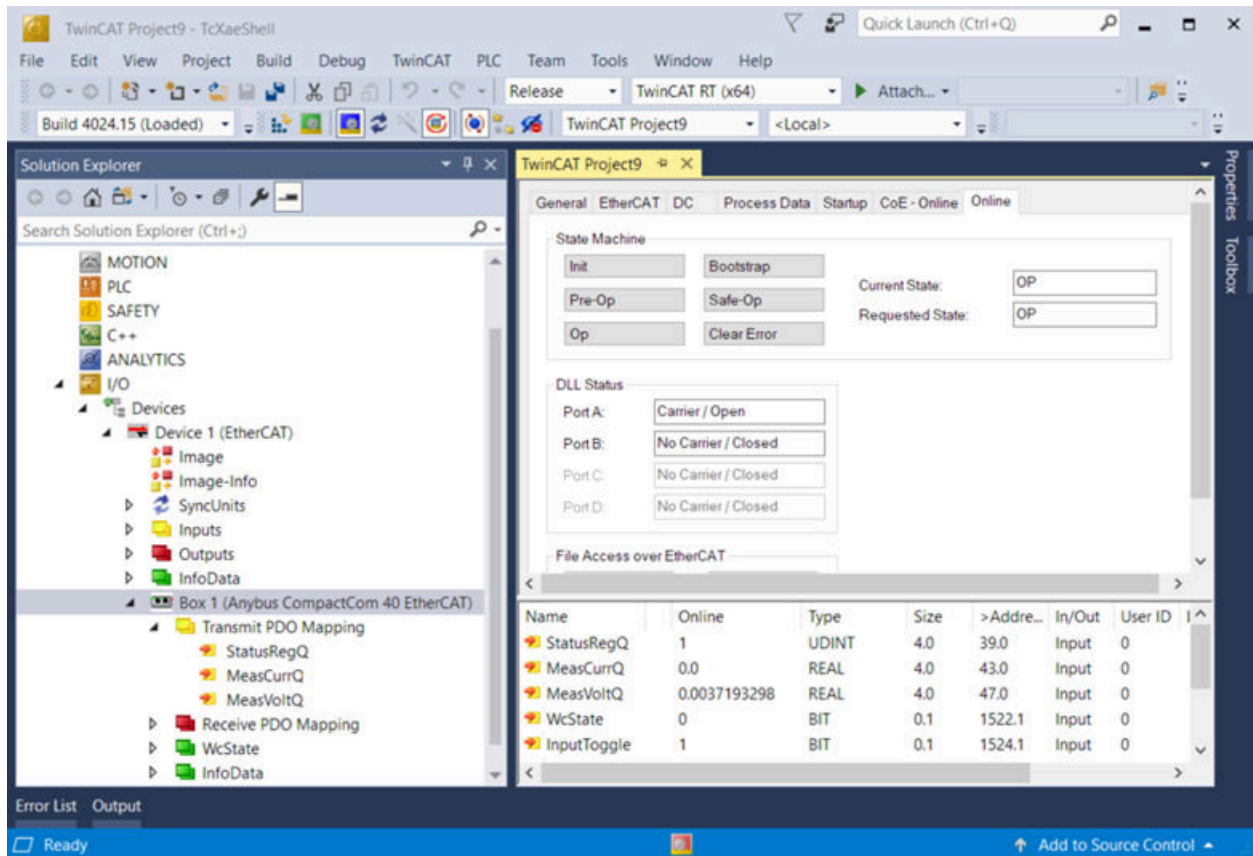

Fig. 12.6: Operation status online tab

12.5.2 PDO Communication

TcXaeShell provides a couple options for reading PDOs

1. In *Box 1 - Transmit PDO Mapping*, PDO variables are listed. Select a variable and open to the *Online* tab to see that variable plotted in time.

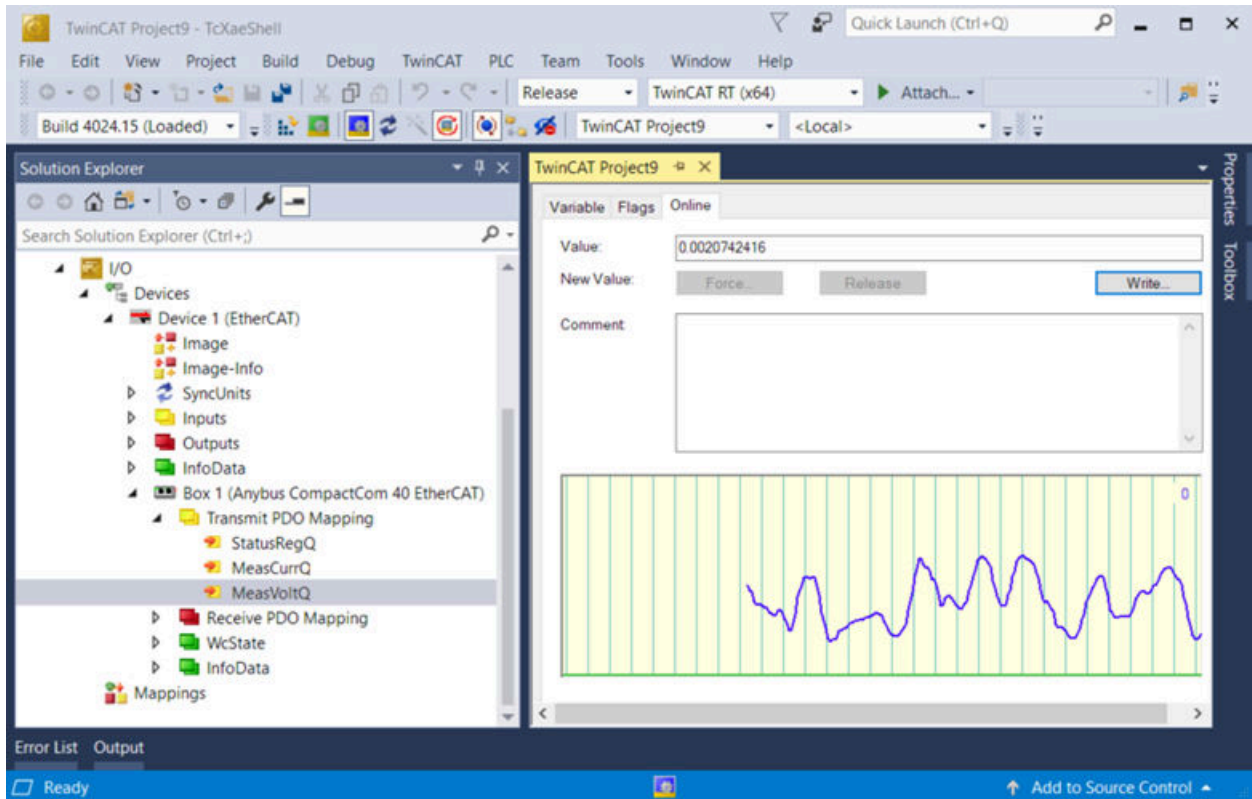

Fig. 12.7: Graphing of a PDO variable

2. Selecting *Box 1* a list all PDOs are presented. Note that *WcState*, *InputToggle*, *State*, and *AdsAddr* are TwinCAT specific variables and can be ignored.

TcXaeShell provides a couple options for writing PDOs

1. In *Solution Explorer* click the desired variable in *Box 1 - Receive PDO Mapping* and open the *Variable* tab.
2. The same can be accomplished by right clicking on the variable and selecting *Online* tab and the *Write* button, which also graphs the value over time.

The *Set Value Dialog* provides entry using multiple number formats. On change, all the fields will update such that numbers are equivalent. *Write value dialog* shows equivalent fields for a *Float* value of 3.7588999. Based what the PDO/SDO variable represents, users may elect to use integer number formats (Dec, Hex, or Binary) instead. Note that byte ordering is swapped for Hex versus Binary.

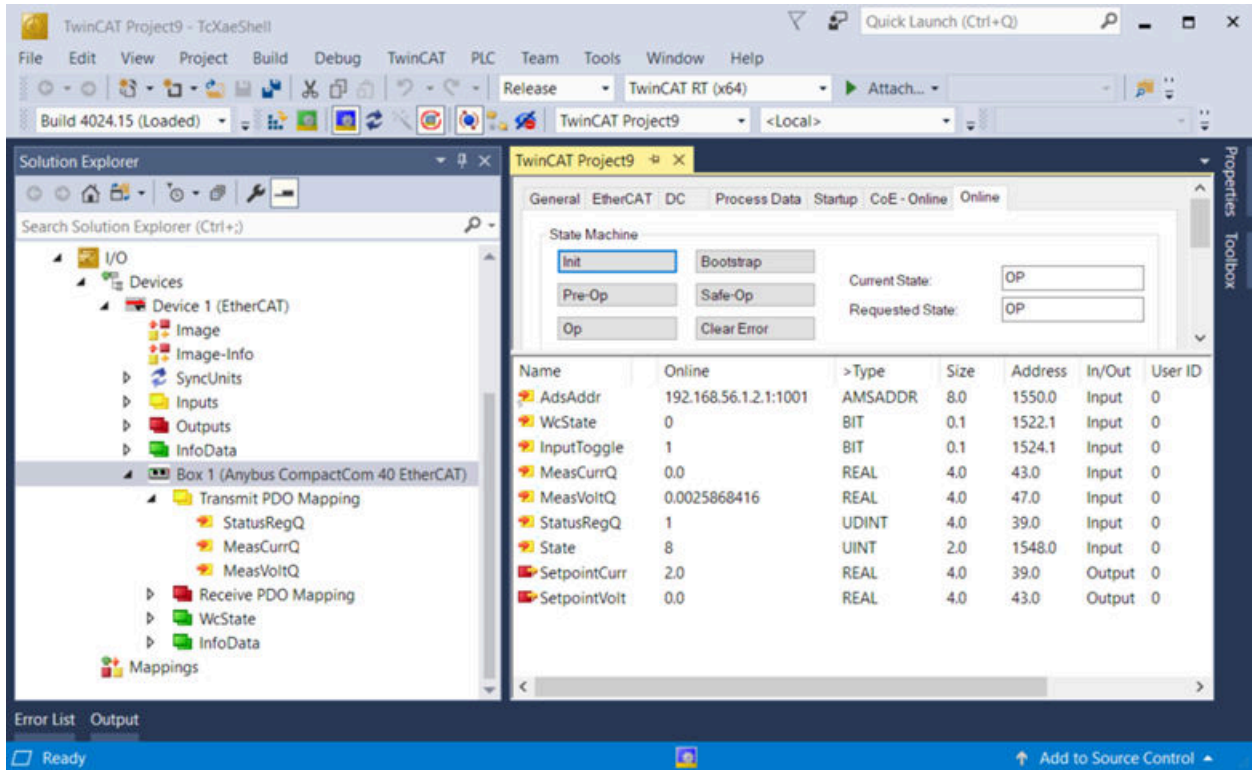

Fig. 12.8: PDO variable listing

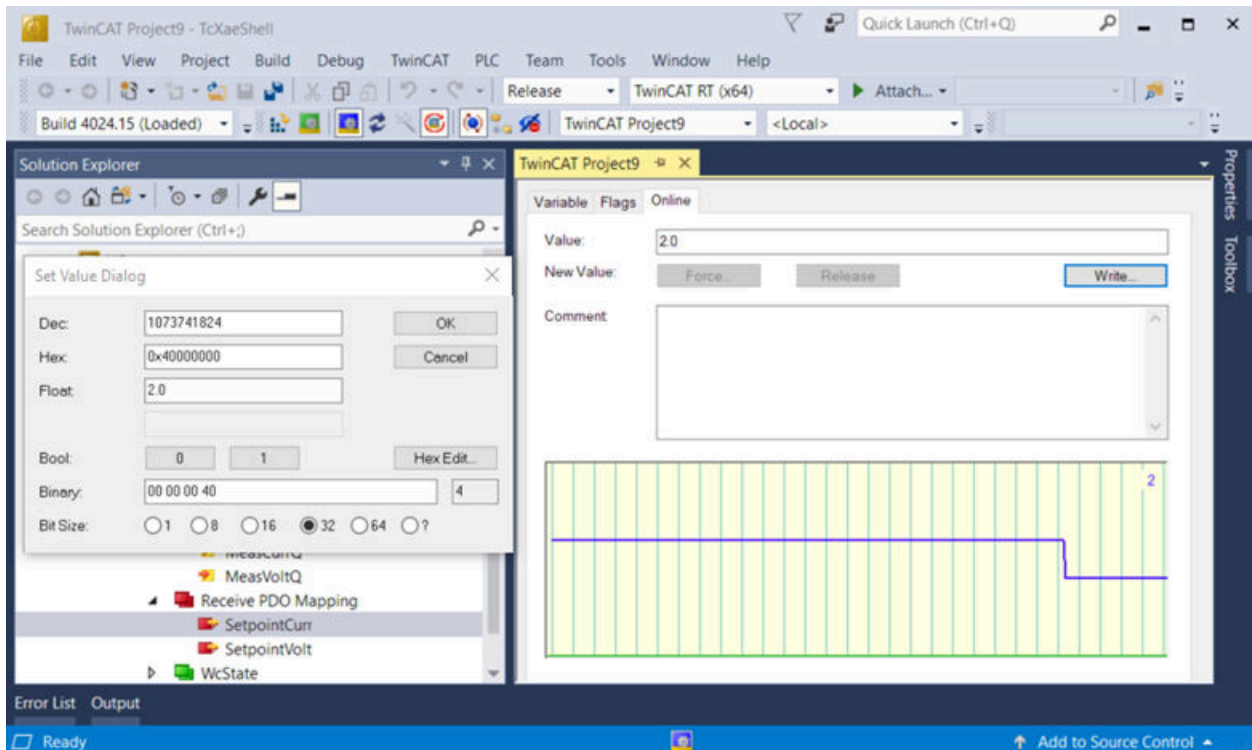

Fig. 12.9: Writing PDO from the Online tab

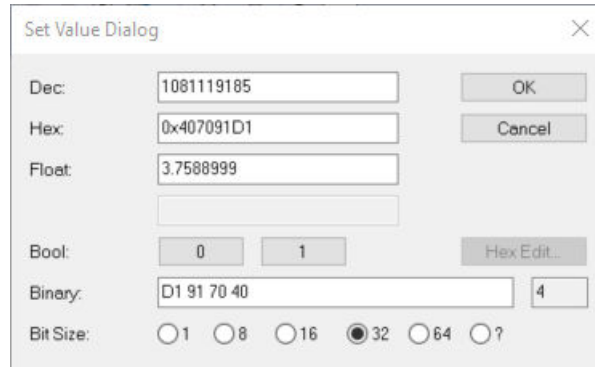

Fig. 12.10: Write value dialog

12.5.3 SDO Communication

SDO variables are listed in *Box 1* and accessed by entering the *CoE - Online* tab. The variables listed in table form are extensive and some time is needed for them to load. To write to an SDO, double click on a variable in the table to open the *Set Value Dialog* window. Only variables with *Flags RW* (read/write) can be written to. Variables that are *RO* (read-only) or a PDO cannot be written to.

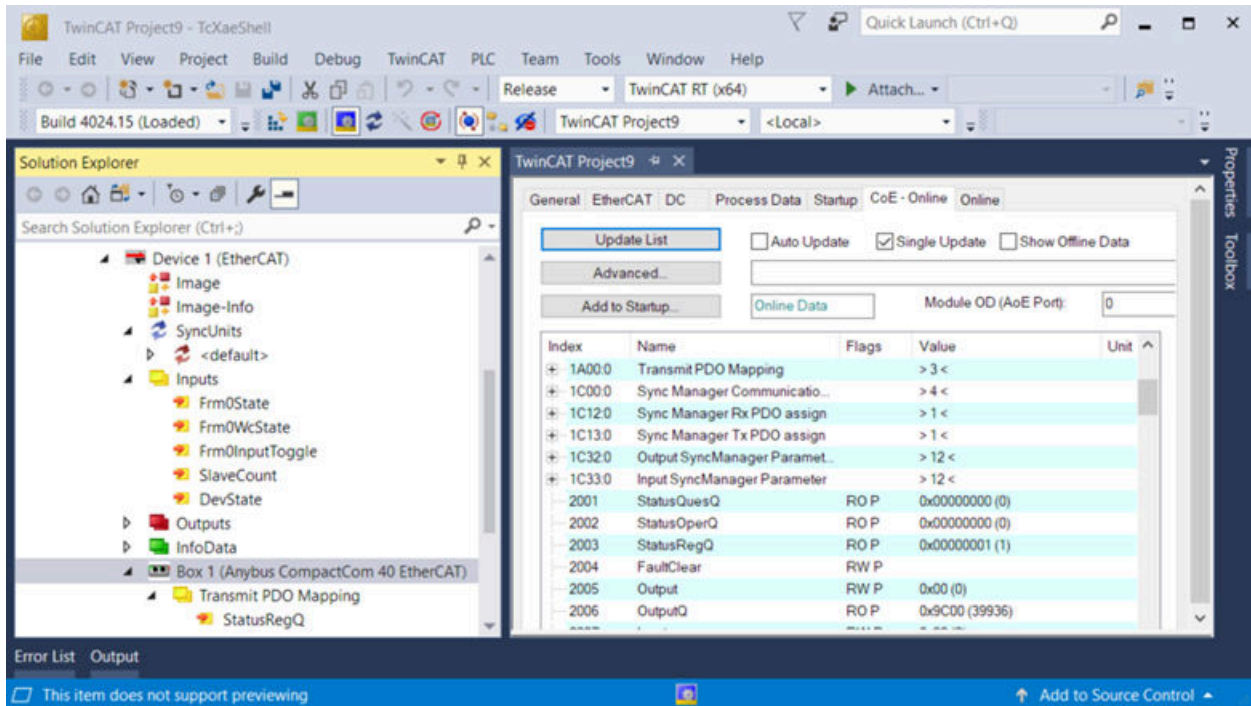

Fig. 12.11: SDO CoE - Online tab

12.6 Standard Object Dictionary

The physical interface to an EtherCAT network is performed with an industrial communication module installed internal to the SLx Series. The module supports CANopen over EtherCAT and complies with draft specification of CiA 301. The specification calls for services and standard data object implementations outlined in the reference material below. The data objects reside in allocated address space shown in *Data object dictionary*

CiA 301

Network Interface Appendix Anybus CompactCom EtherCAT Doc.Id. HMSI-168-65

Table 12.5: Data object dictionary

Index	Object
0x0000	Not used
0x0001-0x001F	Static data types
0x0020-0x003F	Complex data types
0x0040-0x005F	Manufacturer specific complex data types
0x0060-0x007F	Device Profile specific static data types
0x0080-0x009F	Device Profile specific complex data types
0x00A0-0x0FFF	Reserved for further use
0x1000-0x1FFF	Communication profile area
0x2000-0x5FFF	Manufacturer specific profile area
0x6000-0x9FFF	Standardised device profile area
0xA000-0xBFFF	Standardised interface profile area
0xC000-0xFFFF	Reserved for further use

12.7 Manufacturer Specific Instances Listing

ECAT Command	Write Index	Read Index	Description
Operation Commands			
<i>StatusQuesQ</i>	N/A	0x200B	Returns the value of the Questionable Status register
<i>StatusRegQ</i>	N/A	0x200D	Status Register
<i>Output</i>	0x200F	0x2010	
Measurement Commands			
<i>MeasCurrQ</i>	N/A	0x2101	Measures and returns the average current at the sense location
<i>MeasVoltQ</i>	N/A	0x2102	Measures and returns the average voltage at the sense location
<i>MeasPwrQ</i>	N/A	0x2103	Measures and returns the instantaneous DC power at sense location
Setpoint Commands			
<i>SetpointCurr</i>	0x2201	0x2202	Sets the current set-point
<i>SetpointVolt</i>	0x2203	0x2204	Sets the voltage set-point
<i>SetpointPwr</i>	0x2205	0x2206	Sets the power set-point
Trip Commands			
<i>OverTripCurr</i>	0x2301	0x2302	Sets the over current trip (OCT) set-point
<i>OverTripVolt</i>	0x2303	0x2304	Sets the over voltage trip (OVT) set-point
<i>OverTripPwr</i>	0x2305	0x2306	Sets the over power trip (OPT) set-point

continues on next page

Table 12.6 – continued from previous page

ECAT Command	Write Index	Read Index	Description
<i>UnderTripVolt</i>	0x2307	0x2308	Sets the under voltage trip (UVT) set-point
Slew Commands			
<i>RiseRampCurr</i>	0x2401	0x2402	Sets the rising slew rate for current when in current regulation state
<i>RiseRampVolt</i>	0x2403	0x2404	Sets the rising slew rate for voltage when in voltage regulation state
<i>RiseRampPwr</i>	0x2405	0x2406	Sets the rising slew rate for power when in power regulation state
<i>FallRampCurr</i>	0x2409	0x240A	Sets the falling slew rate for current when in current regulation state
<i>FallRampVolt</i>	0x240B	0x240C	Sets the falling slew rate for voltage when in voltage regulation state
<i>FallRampPwr</i>	0x240D	0x240E	Sets the falling slew rate for power when in power regulation
Control Commands			
<i>ControlMode</i>	0x2503	0x2504	Sets the control mode
<i>FactoryRestore</i>	0x2701	N/A	Restores the factory EEPROM data
<i>Lock</i>	0x2703	0x2702	Locks and unlocks the product from configuration and set-point changes
<i>SenseMode</i>	0x2706	0x2707	Configures the sense location and automated compensation values
<i>CommProt</i>	0x2708	0x2709	Changes the communication protocol
<i>SetSource</i>	0x270A	0x270B	Sets the setpoint source

12.8 Manufacturer Specific Process Data Objects

12.8.1 Operation Commands

12.8.2 StatusRegQ

This command queries the Status Register. This read-only register holds the live (unlatched) operation status of the MagnaDC power supply. Issuing a query does not clear the register. The register location and definitions are subject to change after any firmware release to accommodate new features. The *Questionable Register* is a subset of the status register and does not change between firmware updates. The present bit assignments are shown in the table below.

Access RO

Data Format 32-bit Integer

Status Register 0

Bit	Name	Description
0	standby	output is in standby
1	live	output is active
2	nonhalt1	available
3	nonhalt2	available
4	overCurrTrip	over current trip
5	overVoltTrip	over voltage trip

continues on next page

Table 12.7 – continued from previous page

Bit	Name	Description
6	overPwrTrip	over power trip
7	remoteSenseLoss	remote sense voltage outside of acceptable bounds
8	underVoltTrip	under voltage trip
9	shutdown	target is creating a shutdown condition
10	linPwrLim	power across linear modules exceed ratings
11	resPwrLim	power across resistors exceed ratings
12	bootFailure	one or multiple target did not boot up
13	bootState	one or more targets are waiting to boot
14	phaseCurr	rated phase current exceeded
15	comm	communications are corrupted
16	overCurrProtect	terminal current exceeded product rating
17	overVoltProtect	terminal voltage exceeded product rating
18	tempRLin	linear module exceeded temperature
19	blownFuse	fuse is blown on the auxiliary power supply
20	interlock	interlock open
21	haltUserClear	available
22	maintenance	maintenance
23	tempDMod	diode modules exceeded temperature
24	incompatibleSysConfig	incompatible system configuration
25	stackOverflow	exceeded firmware stack
26	lineFault	line fault analog/digital inputs
27	tempRMod	resistor module exceeded temperature
28	belowRatedMinVolt	below minimum voltage rating(28)
29	outOfRegulation	out of regulation, unexpected currents measured
30	targetUpgrade	mainctrl upgrading other targets
31	haltSelfClear	available

Status Register 1

Bit	Name	Description
0	phaseLoss	one or more phase missing
1	blownFuseInput	input fuse blown on fuse/emi filter
2	fanLockedRotor	one or more fan's rotor has locked
3	notUsed29	available
4	tempPwrMod	power processing module temperature fault
5	tempOutputMod	output filter module temperature fault
6	tempOutputCap	output capacitors temperature fault
7	tempTransformer	transformer exceeded temperature fault
8	notUsed26	available
9	notUsed27	available
10	notUsed28	available
11	notUsed1	available
12	notUsed2	available
13	notUsed3	available
14	notUsed4	available
15	notUsed5	available
16	invalidSysRating	invalid system rating
17	fwVersConflict	firmware version conflict
18	notUsed8	available

continues on next page

Table 12.8 – continued from previous page

Bit	Name	Description
19	notUsed9	available
20	notUsed10	available
21	notUsed11	available
22	notUsed12	available
23	notUsed13	available
24	notUsed14	available
25	notUsed15	available
26	notUsed16	available
27	notUsed17	available
28	notUsed18	available
29	notUsed19	available
30	notUsed20	available
31	notUsed21	available

12.8.3 Measurement Commands

12.8.4 MeasCurrQ

This query commands the MagnaDC power supply to measure and return the average current through the DC terminals.

Access RO

Data Format 32-bit Floating Point Number

12.8.5 MeasVoltQ

This query commands the MagnaDC power supply to measure and return the average voltage at the DC terminals. If the remote sense function is used and engaged, this command returns the voltage measured at the sense terminals.

Access RO

Data Format 32-bit Floating Point Number

12.8.6 Setpoint Commands

12.8.7 SetpointCurr

This command programs the current set-point that the MagnaDC power supply will regulate to when operating in constant current mode.

Access RW

Data Format 32-bit Floating Point Number

12.8.8 SetpointVolt

This command programs the voltage set-point, in volts, which the MagnaDC power supply will regulate to when operating in constant voltage mode.

Access RW

Data Format 32-bit Floating Point Number

12.9 Manufacturer Specific Service Data Objects

12.9.1 Operation Commands

StatusQuesQ

This command queries and returns the values of the Questionable Register. This read-only register holds the live (un-latched) questionable statuses of the MagnaDC power supply. Issuing this query does not clear the register. The bit configuration of the Questionable Register is shown in the table below.

Index 0x200B

Access RO

Data Format 32-bit Integer

Questionable Register

Bit	Weight	Abbreviation	Description
0	1	OVP	over voltage protection, hard fault
1	2	OCT	over current trip, soft fault
2	4	OVT	over voltage trip, soft fault
3	8	OPT	over power trip, soft fault
4	16	OCP	over current protection, hard fault
5	32	OTP	over temperature protection, hard fault
6	64	RSL	remote sense loss, hard fault
7	128	CC	constant current regulation, regulation status
8	256	CV	constant voltage regulation, regulation status
9	512	CR	constant resistance regulation, regulation status
10	1024	CP	constant power regulation, regulation status
11	2048	SFLT	soft fault, the ord value of all soft faults
12	4096	HFLT	hard fault, the ord value of all hard faults
13	8192	ILOC	interlock open
14	16384	IPL	input power loss fault
15	32768	ADIF	analog or digital input fault

StatusRegQ

This command queries the Status Register. This read-only register holds the live (unlatched) operation status of the MagnaDC power supply. Issuing a query does not clear the register. The register location and definitions are subject to change after any firmware release to accommodate new features. The *Questionable Register* is a subset of the status register and does not change between firmware updates. The present bit assignments are shown in the table below.

Index 0x200D

Access RO

Data Format 32-bit Integer

Status Register 0

Bit	Name	Description
0	standby	output is in standby
1	live	output is active
2	nonhalt1	available
3	nonhalt2	available
4	overCurrTrip	over current trip
5	overVoltTrip	over voltage trip
6	overPwrTrip	over power trip
7	remoteSenseLoss	remote sense voltage outside of acceptable bounds
8	underVoltTrip	under voltage trip
9	shutdown	target is creating a shutdown condition
10	linPwrLim	power across linear modules exceed ratings
11	resPwrLim	power across resistors exceed ratings
12	bootFailure	one or multiple target did not boot up
13	bootState	one or more targets are waiting to boot
14	phaseCurr	rated phase current exceeded
15	comm	communications are corrupted
16	overCurrProtect	terminal current exceeded product rating
17	overVoltProtect	terminal voltage exceeded product rating
18	tempRLin	linear module exceeded temperature
19	blownFuse	fuse is blown on the auxiliary power supply
20	interlock	interlock open
21	haltUserClear	available
22	maintenance	maintenance
23	tempDMod	diode modules exceeded temperature
24	incompatibleSysConfig	incompatible system configuration
25	stackOverflow	exceeded firmware stack
26	lineFault	line fault analog/digital inputs
27	tempRMod	resistor module exceeded temperature
28	belowRatedMinVolt	below minimum voltage rating(28)
29	outOfRegulation	out of regulation, unexpected currents measured
30	targetUpgrade	mainctrl upgrading other targets
31	haltSelfClear	available

Status Register 1

Bit	Name	Description
0	phaseLoss	one or more phase missing

continues on next page

Table 12.10 – continued from previous page

Bit	Name	Description
1	blownFuseInput	input fuse blown on fuse/emi filter
2	fanLockedRotor	one or more fan's rotor has locked
3	notUsed29	available
4	tempPwrMod	power processing module temperature fault
5	tempOutputMod	output filter module temperature fault
6	tempOutputCap	output capacitors temperature fault
7	tempTransformer	transformer exceeded temperature fault
8	notUsed26	available
9	notUsed27	available
10	notUsed28	available
11	notUsed1	available
12	notUsed2	available
13	notUsed3	available
14	notUsed4	available
15	notUsed5	available
16	invalidSysRating	invalid system rating
17	fwVersConflict	firmware version conflict
18	notUsed8	available
19	notUsed9	available
20	notUsed10	available
21	notUsed11	available
22	notUsed12	available
23	notUsed13	available
24	notUsed14	available
25	notUsed15	available
26	notUsed16	available
27	notUsed17	available
28	notUsed18	available
29	notUsed19	available
30	notUsed20	available
31	notUsed21	available

Output

This command enables or disables the MagnaDC power supply output. A *1* indicates the product's power processing circuit is active and processing power, while a *0* indicates the power supply is in standby or faulted state.

Index 0x200F

Access RW

Data Format Boolean

Index 0x2010

Access RO

Data Format Boolean

12.9.2 Measurement Commands

MeasCurrQ

This query commands the MagnaDC power supply to measure and return the average current through the DC terminals.

Index 0x2101

Access RO

Data Format 32-bit Floating Point Number

MeasVoltQ

This query commands the MagnaDC power supply to measure and return the average voltage at the DC terminals. If the remote sense function is used and engaged, this command returns the voltage measured at the sense terminals.

Index 0x2102

Access RO

Data Format 32-bit Floating Point Number

MeasPwrQ

This query commands the MagnaDC power supply to measure and return the average power at the DC terminals.

Index 0x2103

Access RO

Data Format 32-bit Floating Point Number

12.9.3 Setpoint Commands

SetpointCurr

This command programs the current set-point that the MagnaDC power supply will regulate to when operating in constant current mode.

Index 0x2201

Access RW

Data Format 32-bit Floating Point Number

Index 0x2202

Access RO

Data Format 32-bit Floating Point Number

SetpointVolt

This command programs the voltage set-point, in volts, which the MagnaDC power supply will regulate to when operating in constant voltage mode.

Index 0x2203

Access RW

Data Format 32-bit Floating Point Number

Index 0x2204

Access RO

Data Format 32-bit Floating Point Number

SetpointPwr

This command programs the power set-point, in watts, which the MagnaDC power supply will regulate to when operating in constant power mode.

Index 0x2205

Access RW

Data Format 32-bit Floating Point Number

Index 0x2206

Access RO

Data Format 32-bit Floating Point Number

12.9.4 Trip Commands

OverTripCurr

This command programs the over current trip (OCT) set-point. If the input current exceeds the over current trip set-point for multiple samples, the input is disconnected and an OCT fault is indicated.

Index 0x2301

Access RW

Data Format 32-bit Floating Point Number

Index 0x2302

Access RO

Data Format 32-bit Floating Point Number

OverTripVolt

This command programs the over voltage trip (OVT) set-point. If the input voltage exceeds the over voltage trip set-point for multiple samples, the input is disconnected and an OVT fault is indicated.

Index 0x2303

Access RW

Data Format 32-bit Floating Point Number

Index 0x2304

Access RO

Data Format 32-bit Floating Point Number

OverTripPwr

This command programs the over power trip (OPT) set-point. If the input power exceeds the over power trip set-point for multiple sample, the input is disconnected and an OPT fault is indicated.

Index 0x2305

Access RW

Data Format 32-bit Floating Point Number

Index 0x2306

Access RO

Data Format 32-bit Floating Point Number

UnderTripVolt

This command programs the under voltage trip (UVT) set-point. If the input voltage falls below the under voltage trip set-point for multiple samples, the input is disconnected and an UVT fault is indicated.

Index 0x2307

Access RW

Data Format 32-bit Floating Point Number

Index 0x2308

Access RO

Data Format 32-bit Floating Point Number

12.9.5 Slew Commands

RiseRampCurr

This command sets the current slew rate for increasing current transitions while in constant current regulation. MAXimum sets the slew to the fastest possible rate. MINimum sets the slew to the slowest rate. Slew rates less than the minimum value are set to MINimum. Slew rate settings less than the minimum value are set to MINimum. Slew rate settings greater than the maximum value are set to MAXimum.

Index 0x2401

Access RW

Data Format 32-bit Floating Point Number

Index 0x2402

Access RO

Data Format 32-bit Floating Point Number

RiseRampVolt

This command sets the voltage slew rate for increasing voltage transitions while in constant voltage regulation. The units for voltage slew rate are volts per millisecond. MAXimum sets the slew to the fastest possible rate. MINimum sets the slew to the slowest rate. Slew rates less than the minimum value are set to MINimum. Slew rate settings less than the minimum value are set to MINimum. Slew rate settings greater than the maximum value are set to MAXimum.

Index 0x2403

Access RW

Data Format 32-bit Floating Point Number

Index 0x2404

Access RO

Data Format 32-bit Floating Point Number

RiseRampPwr

This command sets the power slew rate for increasing power transitions while in constant power regulation. The units for power slew rate are watts per millisecond. MAXimum sets the slew to the fastest possible rate. MINimum sets the slew to the slowest rate. Slew rates less than the minimum value are set to MINimum. Slew rate settings less than the minimum value are set to MINimum. Slew rate settings greater than the maximum value are set to MAXimum.

Index 0x2405

Access RW

Data Format 32-bit Floating Point Number

Index 0x2406

Access RO

Data Format 32-bit Floating Point Number

FallRampCurr

This command sets the current slew rate for decreasing current transitions while in constant current regulation. MAXimum sets the slew to the fastest possible rate. MINimum sets the slew to the slowest rate. Slew rates less than the minimum value are set to MINimum. Slew rate settings less than the minimum value are set to MINimum. Slew rate settings greater than the maximum value are set to MAXimum.

Index 0x2409

Access RW

Data Format 32-bit Floating Point Number

Index 0x240A

Access RO

Data Format 32-bit Floating Point Number

FallRampVolt

This command sets the voltage slew rate for decreasing voltage transitions while in constant voltage regulation. The units for voltage slew rate are volts per millisecond. MAXimum sets the slew to the fastest possible rate. MINimum sets the slew to the slowest rate. Slew rates less than the minimum value are set to MINimum. Slew rate settings less than the minimum value are set to MINimum. Slew rate settings greater than the maximum value are set to MAXimum.

Index 0x240B

Access RW

Data Format 32-bit Floating Point Number

Index 0x240C

Access RO

Data Format 32-bit Floating Point Number

FallRampPwr

This command sets the power slew rate for decreasing power transitions while in constant power regulation. The units for power slew rate are watts per millisecond. MAXimum sets the slew to the fastest possible rate. MINimum sets the slew to the slowest rate. Slew rates less than the minimum value are set to MINimum. Slew rate settings less than the minimum value are set to MINimum. Slew rate settings greater than the maximum value are set to MAXimum.

Index 0x240D

Access RW

Data Format 32-bit Floating Point Number

Index 0x240E

Access RO

Data Format 32-bit Floating Point Number

12.9.6 Control Commands

ControlMode

This command configures the MagnaDC power supply's control mode. *Control Modes* provides more information about the various options.

Index 0x2503

Access RW

Data Format 16-bit Integer

Index 0x2504

Access RO

Data Format 16-bit Integer

FactoryRestore

This command performs a *factory restore* to default EPROM values. Both Soft Restore and Hard Restore are available through command parameters.

Index 0x2701

Access RW

Data Format 16-bit Integer

Lock

This command configures the MagnaDC power supply's lock state. While locked, the stop button is the only functional button on the front panel. See *Lock* for more details on how lock works and how behaves relative to other locking inputs (front panel and digital input).

Index 0x2703

Access RW

Data Format Boolean

Index 0x2702

Access RO

Data Format Boolean

SenseMode

This command configures where the MagnaDC power supply senses voltage. The sense location also effects how power and resistance are calculated. Local sensing monitors the directly across the output terminals. Remote sensing, as described in *Remote Sense Connection*, measures across the terminal JS2. This external connection can be used to improve regulation at the point of load, as is needed for example, in compensating voltage drops caused by wire resistance.

Index 0x2706

Access RW

Data Format 16-bit Integer

Index 0x2707

Access RO

Data Format 16-bit Integer

CommProt

This command changes the command protocol of the MagnaDC power supply.

Index 0x2708

Access RW

Data Format 16-bit Integer

Index 0x2709

Access RO

Data Format 16-bit Integer

SetSource

The command selects and routes different set points sources to the digital controller. Operation of this feature is described in *Set Point Source*. By default, the source is set to *local* (value 0), where set points originating from the front panel or communication interfaces are routed to the SLx Series digital control. When the source is set to *function generator* (value 1), set points are generated internally, by a periodic function generator block. When *external analog input* (value 3) is set, the voltage(s) applied to the rear connector are converted into set points.

Index 0x270A

Access RW

Data Format 16-bit Integer

Index 0x270B

Access RO

Data Format 16-bit Integer

PROFINET COMMAND SET

13.1 PROFINET Overview

PROFINET, short for Process Field Network, is a widely used industrial Ethernet-based communication protocol that enables efficient and robust data exchange in industrial automation systems. It is an open standard developed and maintained by PROFIBUS & PROFINET International, an organization dedicated to industrial communication technologies. Designed to meet the growing demands of modern industrial automation, PROFINET offers real-time communication capabilities, high-speed data transfer, and seamless integration with various automation devices and systems. It provides a flexible and scalable solution for connecting field devices, controllers, sensors, and actuators across different levels of an industrial network. Magna-Power devices support are version of PROFINET with isochronous real time (IRT), which handles time-critical data exchange, capable of cycle times down to 31.25 μ s and 1 μ s of jitter.

Key Features and Benefits:

- **High Performance:** PROFINET offers real-time communication with deterministic behavior, ensuring precise synchronization and timely data exchange. It supports high-speed data transfer rates, allowing for rapid control and monitoring of industrial processes.
- **Flexibility and Scalability:** PROFINET provides a flexible network architecture that adapts to the changing requirements of industrial environments. It supports various topologies, including line, star, ring, and tree, enabling easy expansion and integration of devices and systems. Additionally, PROFINET supports the use of standard Ethernet infrastructure, simplifying network deployment and maintenance.
- **Seamless Integration:** PROFINET enables seamless integration of different devices and systems, regardless of the manufacturer or technology used. It supports interoperability between PROFINET-enabled devices and other industrial protocols, facilitating communication between heterogeneous systems.
- **Diagnostics and Maintenance:** PROFINET offers extensive diagnostic capabilities, allowing users to monitor the network health, detect faults, and perform maintenance tasks efficiently. It provides real-time status information, device parameterization, and remote access for troubleshooting, reducing downtime and improving overall system reliability.
- **Safety and Security:** PROFINET incorporates robust security mechanisms to protect industrial networks and data. It supports encryption, authentication, and access control, ensuring the confidentiality and integrity of transmitted information. Additionally, PROFINET includes safety extensions for implementing safety-related applications, complying with relevant safety standards.
- **Integration with IT Systems:** PROFINET bridges the gap between operational technology, information technology (IT) systems. It enables seamless integration with enterprise-level systems, such as Manufacturing Execution Systems (MES) or Enterprise Resource Planning (ERP) systems, providing valuable data for analysis, optimization, and decision-making.

For a more complete overview of PROFINET and underlining standards, visit PROFIBUS.com .

13.1.1 General Station Description

When developing or using PROFINET software to talk to a Magna-Power Electronics PROFINET module, a general station description (GSD) should be imported into PLC development software. The GSD is a custom file created by the device manufacturer that describes communication parameters, available services, data types, and device identification. The file may be requested as part of the setup process in PLC programming or installing third-party software. The GSD can be download below and was use for *Communication Examples*.

Magna-Power Electronics General Station Description

13.2 Physical Interface

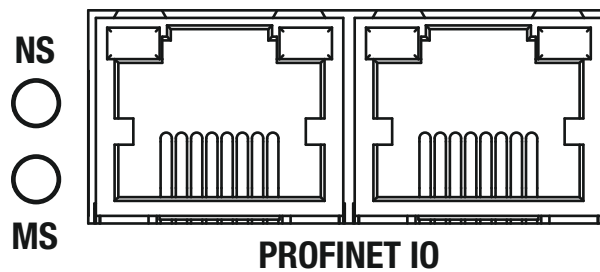

Fig. 13.1: Rear interface

13.2.1 Ethernet Ports

The SLx Series has two 100 Mbps RJ-45 Ethernet ports on the rear of the unit for PROFINET communications, shown in *Rear interface* labeled *PROFINET IO*. Either port may be used, with the other port acting as an Ethernet passthrough.

13.2.2 LED Codes

In the rear of the SLx Series is a communications interface with two exposed bi-color LEDs. The LED labeled NS indicates network status and the one labeled MS indicates module status, as shown in *Rear interface*. Status is indicated using colors and blink patterns, as shown in the tables below.

Table 13.1: NS LED States

State	Description
Off	Offline
Green	Online (RUN state)
Green, 1 flash	Online (STOP state)
Green, cont. flash	DCP identify
Red	Fatal error
Red, 1 flash	Station name error
Red, 2 flashes	IP address error
Red, 3 flashes	Configuration error

Table 13.2: MS LED States

State	Description
Off	Not initialized
Green	Normal operation
Green, 1 flash	Diagnostic event
Red	Exception error (fatal when combined with red NS LED)

The RJ-45 Ethernet ports have two LEDs that indicate the status of the Ethernet connection. Link and activity status are indicated using colors and blink patterns, as shown in the tables below.

Table 13.3: Top-left RJ-45 LED States

State	Description
Off	No link
Green	Ethernet link (100 Mbps) established
Green, flashing	Activity (100 Mbps)

Table 13.4: Top-right RJ-45 LED States

State	Description
Off	No link
Orange	Ethernet link (10 Mbps) established
Orange, flashing	Activity (10 Mbps)

13.3 Communication Examples

Work in progress

13.4 Instances Listing

CANOPEN COMMAND SET

14.1 CANopen Overview

CANopen is a real-time, high-speed CAN-based protocol specified by CiA (CAN in Automation) for communicating among multiple nodes. CANopen networks are formed using twisted-pair cabling, where all network nodes can be directly wired together through D-sub connectors.

CANopen EDS (electronic datasheet) files are used to describe the communication parameters and object dictionary of CANopen nodes. Magna-Power Electronics provides this EDS file to customers which contains identifying information, supported communication objects, and parameter settings.

Magna-Power Electronics has implemented basic process data objects (PDOs) for use with our products. Customer PDO remapping is not supported. Layer setting services (LSS) is supported to change the node ID and baud rate of each node.

14.2 Physical Interface

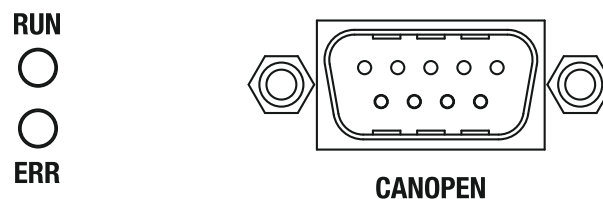

Fig. 14.1: Rear interface

14.2.1 D-sub 9 Port

The SLx Series has a single, male D-sub 9 port on the rear of the unit for CANopen communications, shown in *Rear interface* labeled *CANOPEN*. The pinout for the D-sub 9 port is as follows:

- Pin 2: CAN_L
- Pin 3: CAN GND (isolated)
- Pin 5: Shield GND
- Pin 7: CAN_H

14.2.2 LED Codes

In the rear of the SLx Series is a communications interface with two exposed bi-color LEDs. The LED labeled RUN indicates status of the CANopen device and the one labeled ERR indicates CANopen communication errors, as shown in *Rear interface*. Status is indicated using colors and blink patterns, as shown in the tables below.

Table 14.1: RUN LED States

State	Description
Off	No power or initializing
Green	Online, operational state
Green, flashing	Online, pre-operational state
Green, 1 flash	Online, stopped state
Green, rapid flickering	Baud rate detection or LSS in progress
Red	Fatal event

Table 14.2: ERR LED States

State	Description
Off	No power or no error
Red, 1 flash	Bus warning limit reached
Red, 2 flashes	Error control event
Red, rapid flickering	LSS in progress
Red	Bus off (fatal event)

14.3 Data Objects

14.3.1 Process Data Objects (PDOs)

PDOs are real-time data frequently sent to and from connected Magna-Power Electronics nodes. When describing PDO traffic, it is referenced with respect to the CANopen slave node. For example, *Transmit PDOs* (TPDO) are transmitted from the slave and are read-only, while *Receive PDOs* (RPDO) transmits variables to the slave and have write access. Measurement readings would be mapped in the TPDO Mapping, whereas set points would be in the RPDO Mapping.

14.3.2 Service Data Objects (SDOs)

SDOs are messages sent on request and have no timing expectations. SDOs are intended for non-real-time communications, as they must wait for the network to respond. They are typically used for reporting the node status, changing operating modes, etc. SDOs variables should not be used to update values already part of a PDO, as they are updated regularly, and the values would be overwritten by the PDO.

14.4 CANopen State Machine

The master controls slaves by following the CANopen state machine. Slaves can transition between four states: Init, Pre-Operational, Operational, and Stopped. In each state, configuration checks are made and different types of communications are allowed. The transition between states are diagrammed in *CANopen state machine*. Allowed communications in each state is described in *Allowed protocols for each state*. Nodes enter Init when first switched-on and reach Operational under normal conditions.

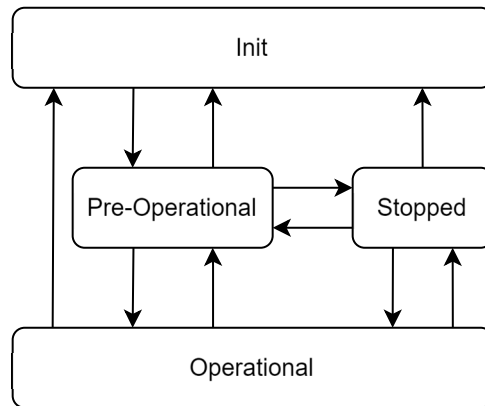

Fig. 14.2: CANopen state machine

Table 14.3: Allowed protocols for each state

State	RSDO/TSDO	TPDO	RPDO
Init			
Pre-Operational	✓		
Operational	✓	✓	✓
Stopped			

14.5 CANopen Default Node Settings

The default settings for Magna-Power Electronics CANopen nodes are as follows:

- Node ID: 0x70
- Data rate: 10 kbps

These settings can be changed using Layer Setting Services (LSS). The exact procedure for changing these settings is device-specific and can be found in your PLC's user manual. The details needed to reconfigure Magna-Power Electronics CANopen nodes are found in *Node details for LSS*. Note that the serial number is a unique identifier for each node and can be found printed on the product label or through the about menu. The serial used for LSS is the part of the serial number that is listed after the - symbol in the product's serial number.

Table 14.4: Node details for LSS

Property	Value
Vendor ID	0x0000001B
Product Code	0x0000000D
Revision Number	0x00010002
Serial Number	<i>product serial</i> (32-bit)

14.6 Development using Python

Communication with Magna-Power Electronics CANopen nodes can be done using the *canopen* Python library. The library allows for communication using CANopen and can be used to read and write data to CANopen nodes. The library is available for download on the Python Package Index (PyPI) using the link: [canopen](#)

A compatible CAN interface is needed. A full list of compatible interfaces is listed in the *canopen* library's documentation, found [here](#). Internally, Magna-Power Electronics uses the *Seed Studio USB to CAN Analyzer* (114991193) for its CANopen development and testing.

14.6.1 Device Setup

Ensure that the *canopen* library and any necessary drivers are installed on your system. In order to correctly access the node's object dictionary, Magna-Power Electronics supplies an EDS file with your CANopen product.

Magna-Power Electronics EDS File

The following code snippet shows how to create a CANopen network and connect to a node with the default node ID of 0x70 and data rate of 10 kbps. Ensure that the bus type and channel are set to the correct values for your interface. This code snippet also assumes that the EDS file is in the same directory as the script.

```
import canopen

# Set the interface port and bitrate
INTERFACE_PORT = 'COM7'
BITRATE = 10000

# Create a CANopen network and connect to the node
network = canopen.Network()
network.connect(bustype='seedstudio', channel=INTERFACE_PORT, bitrate=BITRATE)
mpeNode = canopen.RemoteNode(0x70, 'mpe_canopen.eds')
network.add_node(mpeNode)

# Set the SDO response timeout to 2 seconds
mpeNode.sdo.RESPONSE_TIMEOUT = 2

# Set the state of the node to pre-operational
mpeNode.nmt.state = 'PRE-OPERATIONAL'

# Add code here to read/write data to the node

network.disconnect()
```

14.6.2 SDO Communication

The available SDO variables are listed in the *Manufacturer Specific Service Data Objects* section. The following code snippet shows how to read and write to an SDO variable.

```
# Read from an SDO variable
current = mpeNode.sdo['MeasCurrQ'].raw

# Write to an SDO variable
mpeNode.sdo['SetpointCurr'].raw = 1.5
```

For SDO variables with multiple subindices, the subindex can be accessed using the following syntax:

```
status0 = mpeNode.sdo["StatusRegQ"][1].raw
status1 = mpeNode.sdo["StatusRegQ"][2].raw
```

14.6.3 PDO Communication

The available PDO variables are listed in the *Manufacturer Specific Process Data Objects* section. Before enabling PDO communication, the PDO configuration must be read from the node. The following code snippet shows how to read the PDO configuration from the connected node.

```
# Read PDO configurations from node
mpeNode.tpdo.read()
mpeNode.rpdo.read()
```

Note that TPDO data is the data transmitted by the Magna-Power Electronics node, while RPDO is the data received by the node.

There are two main ways to access PDO data: using the *sync method* or by using up an *event timer*. The *sync method* is used to sync the PDO data with the node when a sync command is sent by the master, while the *event timer* is used to specify the interval at which the node should transmit and receive its PDO data. The following code snippet shows how to setup the *sync method* to read PDO data and print to the console. Note that sync commands can be sent manually, or at fixed intervals as shown in the code.

```
# Set TPDO 1's transmit mode to sync
mpeNode.sdo['TPDO communication parameter 1']['Transmission type'].raw = 1

# Send a single sync command to the node
network.sync.transmit()

# Set up sync timer for automatic sync transmission
network.sync.start(0.25) # Sync every 0.25 seconds

# Change state to operational (NMT start)
mpeNode.nmt.state = 'OPERATIONAL'
```

The following code snippet uses an *event timer* to automatically transmit the data without the need for a sync command:

```
# Set TPDO 1's transmit mode to be internal-event triggered
mpeNode.sdo['TPDO communication parameter 1']['Transmission type'].raw = 255

# Set event timer to 250 ms
mpeNode.sdo['TPDO communication parameter 1']['Event timer'].raw = 250

# Change state to operational (NMT start)
mpeNode.nmt.state = 'OPERATIONAL'
```

14.6.4 Layer Setting Services (LSS)

Layer setting services (LSS) can be used to change the node ID and data rate of a target CANopen node to meet the demands of your network. There are two possible states for LSS: configuration and waiting. In the *configuration* state, the LSS master can change the node ID and data rate of the node. In the *waiting* state, the node operates normally.

There are two methods to bring a node into the configuration state. The first method is selective and requires knowledge of the connected node's properties. These include the vendor ID, product code, revision number, and serial number. The default values for these properties can be found in *Node details for LSS*. To selectively request the node to enter the configuration state, the following code snippet can be used:

```
network.lss.send_switch_state_selective(vendorId=0x1B, productCode=0xD, ↵
↵revisionNumber=0x10002, serialNumber=SERIAL_NUMBER)
```

If the node's properties are not known, users can globally request all connected nodes to enter the configuration state. The following code snippet can be used to globally request all connected nodes to enter the configuration state:

```
network.lss.send_switch_state_global(network.lss.CONFIGURATION_STATE)
```

Once a node is in the LSS configuration state, the node ID and data rate can be changed. The following code snippet shows how to change these settings:

```
# Change the node ID to 0x71
network.lss.configure_node_id(0x71)

# Change the data rate to 500 kbps
network.lss.configure_bit_timing(2)
```

Note that when setting the node ID, only one node should be connected to the CANopen network to prevent address conflicts. This node ID can be set to any value between 0x01 and 0x7F. Data rates are set based on bit-timing values, as shown in *Bit timing values for different data rates*.

Table 14.5: Bit timing values for different data rates

idx	Data rate
8	10 kbps
7	20 kbps
6	50 kbps
5	100 kbps
4	125 kbps
3	250 kbps
2	500 kbps
1	800 kbps
0	1 Mbps

Finally, once the node is configured, the settings can be saved and the nodes can be brought back into the operational state using the following code snippet:

```
network.lss.store_configuration()
network.lss.send_switch_state_global(network.lss.WAITING_STATE)
```

14.7 Standard Object Dictionary

The physical interface to a CANopen network is performed with an industrial communication module installed internal to the SLx Series. The module complies with version 4.2.0 of the CiA 301 specification. This specification calls for services and standard data object implementations outlined in the reference material below. The data objects reside in allocated address space shown in *Data object dictionary*

CiA 301

Network Interface Appendix Anybus CompactCom CANopen Doc.Id. SCM-1202-108

Table 14.6: Data object dictionary

Index	Object
0x0000	Reserved
0x001-0x025F	Data types
0x0260-0x0FFF	Reserved
0x1000-0x1FFF	Communication profile area
0x2000-0x5FFF	Manufacturer specific profile area
0x6000-0x9FFF	Standardized device profile area
0xA000-0xBFFF	Standardized interface profile area
0xC000-0xFFFF	Reserved

14.8 Manufacturer Specific Instances Listing

CANopen Command	Write Index	Read Index	Description
Operation Commands			
<i>StatusQuesQ</i>	N/A	0x200B	Returns the value of the Questionable Status register
<i>StatusRegQ</i>	N/A	0x200D	Status Register
<i>Output</i>	0x200F	0x2010	
Measurement Commands			
<i>MeasCurrQ</i>	N/A	0x2101	Measures and returns the average current at the sense location
<i>MeasVoltQ</i>	N/A	0x2102	Measures and returns the average voltage at the sense location
<i>MeasPwrQ</i>	N/A	0x2103	Measures and returns the instantaneous DC power at sense location
Setpoint Commands			
<i>SetpointCurr</i>	0x2201	0x2202	Sets the current set-point
<i>SetpointVolt</i>	0x2203	0x2204	Sets the voltage set-point
<i>SetpointPwr</i>	0x2205	0x2206	Sets the power set-point
Trip Commands			
<i>OverTripCurr</i>	0x2301	0x2302	Sets the over current trip (OCT) set-point
<i>OverTripVolt</i>	0x2303	0x2304	Sets the over voltage trip (OVT) set-point
<i>OverTripPwr</i>	0x2305	0x2306	Sets the over power trip (OPT) set-point
<i>UnderTripVolt</i>	0x2307	0x2308	Sets the under voltage trip (UVT) set-point
Slew Commands			
<i>RiseRampCurr</i>	0x2401	0x2402	Sets the rising slew rate for current when in current regulation state

continues on next page

Table 14.7 – continued from previous page

CANopen Command	Write Index	Read Index	Description
<i>RiseRampVolt</i>	0x2403	0x2404	Sets the rising slew rate for voltage when in voltage regulation state
<i>RiseRampPwr</i>	0x2405	0x2406	Sets the rising slew rate for power when in power regulation state
<i>FallRampCurr</i>	0x2409	0x240A	Sets the falling slew rate for current when in current regulation state
<i>FallRampVolt</i>	0x240B	0x240C	Sets the falling slew rate for voltage when in voltage regulation state
<i>FallRampPwr</i>	0x240D	0x240E	Sets the falling slew rate for power when in power regulation
Control Commands			
<i>ControlMode</i>	0x2503	0x2504	Sets the control mode
<i>FactoryRestore</i>	0x2701	N/A	Restores the factory EEPROM data
<i>Lock</i>	0x2703	0x2702	Locks and unlocks the product from configuration and set-point changes
<i>SenseMode</i>	0x2706	0x2707	Configures the sense location and automated compensation values
<i>CommProt</i>	0x2708	0x2709	Changes the communication protocol
<i>SetSource</i>	0x270A	0x270B	Sets the setpoint source

14.9 Manufacturer Specific Process Data Objects

14.9.1 Operation Commands

14.9.2 StatusRegQ

This command queries the Status Register. This read-only register holds the live (unlatched) operation status of the MagnaDC power supply. Issuing a query does not clear the register. The register location and definitions are subject to change after any firmware release to accommodate new features. The *Questionable Register* is a subset of the status register and does not change between firmware updates. The present bit assignments are shown in the table below.

Access RO

Data Format 32-bit Integer

Status Register 0

Bit	Name	Description
0	standby	output is in standby
1	live	output is active
2	nonhalt1	available
3	nonhalt2	available
4	overCurrTrip	over current trip
5	overVoltTrip	over voltage trip
6	overPwrTrip	over power trip
7	remoteSenseLoss	remote sense voltage outside of acceptable bounds
8	underVoltTrip	under voltage trip
9	shutdown	target is creating a shutdown condition

continues on next page

Table 14.8 – continued from previous page

Bit	Name	Description
10	linPwrLim	power across linear modules exceed ratings
11	resPwrLim	power across resistors exceed ratings
12	bootFailure	one or multiple target did not boot up
13	bootState	one or more targets are waiting to boot
14	phaseCurr	rated phase current exceeded
15	comm	communications are corrupted
16	overCurrProtect	terminal current exceeded product rating
17	overVoltProtect	terminal voltage exceeded product rating
18	tempRLin	linear module exceeded temperature
19	blownFuse	fuse is blown on the auxiliary power supply
20	interlock	interlock open
21	haltUserClear	available
22	maintenance	maintenance
23	tempDMod	diode modules exceeded temperature
24	incompatibleSysConfig	incompatible system configuration
25	stackOverflow	exceeded firmware stack
26	lineFault	line fault analog/digital inputs
27	tempRMod	resistor module exceeded temperature
28	belowRatedMinVolt	below minimum voltage rating(28)
29	outOfRegulation	out of regulation, unexpected currents measured
30	targetUpgrade	mainctrl upgrading other targets
31	haltSelfClear	available

Status Register 1

Bit	Name	Description
0	phaseLoss	one or more phase missing
1	blownFuseInput	input fuse blown on fuse/emi filter
2	fanLockedRotor	one or more fan's rotor has locked
3	notUsed29	available
4	tempPwrMod	power processing module temperature fault
5	tempOutputMod	output filter module temperature fault
6	tempOutputCap	output capacitors temperature fault
7	tempTransformer	transformer exceeded temperature fault
8	notUsed26	available
9	notUsed27	available
10	notUsed28	available
11	notUsed1	available
12	notUsed2	available
13	notUsed3	available
14	notUsed4	available
15	notUsed5	available
16	invalidSysRating	invalid system rating
17	fwVersConflict	firmware version conflict
18	notUsed8	available
19	notUsed9	available
20	notUsed10	available
21	notUsed11	available
22	notUsed12	available

continues on next page

Table 14.9 – continued from previous page

Bit	Name	Description
23	notUsed13	available
24	notUsed14	available
25	notUsed15	available
26	notUsed16	available
27	notUsed17	available
28	notUsed18	available
29	notUsed19	available
30	notUsed20	available
31	notUsed21	available

14.9.3 Measurement Commands

14.9.4 MeasCurrQ

This query commands the MagnaDC power supply to measure and return the average current through the DC terminals.

Access RO

Data Format 32-bit Floating Point Number

14.9.5 MeasVoltQ

This query commands the MagnaDC power supply to measure and return the average voltage at the DC terminals. If the remote sense function is used and engaged, this command returns the voltage measured at the sense terminals.

Access RO

Data Format 32-bit Floating Point Number

14.9.6 Setpoint Commands

14.9.7 SetpointCurr

This command programs the current set-point that the MagnaDC power supply will regulate to when operating in constant current mode.

Access RW

Data Format 32-bit Floating Point Number

14.9.8 SetpointVolt

This command programs the voltage set-point, in volts, which the MagnaDC power supply will regulate to when operating in constant voltage mode.

Access RW

Data Format 32-bit Floating Point Number

14.10 Manufacturer Specific Service Data Objects

14.10.1 Operation Commands

StatusQuesQ

This command queries and returns the values of the Questionable Register. This read-only register holds the live (un-latched) questionable statuses of the MagnaDC power supply. Issuing this query does not clear the register. The bit configuration of the Questionable Register is shown in the table below.

Index 0x200B

Access RO

Data Format 32-bit Integer

Questionable Register

Bit	Weight	Abbreviation	Description
0	1	OVP	over voltage protection, hard fault
1	2	OCT	over current trip, soft fault
2	4	OVT	over voltage trip, soft fault
3	8	OPT	over power trip, soft fault
4	16	OCP	over current protection, hard fault
5	32	OTP	over temperature protection, hard fault
6	64	RSL	remote sense loss, hard fault
7	128	CC	constant current regulation, regulation status
8	256	CV	constant voltage regulation, regulation status
9	512	CR	constant resistance regulation, regulation status
10	1024	CP	constant power regulation, regulation status
11	2048	SFLT	soft fault, the ord value of all soft faults
12	4096	HFLT	hard fault, the ord value of all hard faults
13	8192	ILOC	interlock open
14	16384	IPL	input power loss fault
15	32768	ADIF	analog or digital input fault

StatusRegQ

This command queries the Status Register. This read-only register holds the live (unlatched) operation status of the MagnaDC power supply. Issuing a query does not clear the register. The register location and definitions are subject to change after any firmware release to accommodate new features. The *Questionable Register* is a subset of the status register and does not change between firmware updates. The present bit assignments are shown in the table below.

Index 0x200D

Access RO

Data Format 32-bit Integer

Status Register 0

Bit	Name	Description
0	standby	output is in standby
1	live	output is active
2	nonhalt1	available
3	nonhalt2	available
4	overCurrTrip	over current trip
5	overVoltTrip	over voltage trip
6	overPwrTrip	over power trip
7	remoteSenseLoss	remote sense voltage outside of acceptable bounds
8	underVoltTrip	under voltage trip
9	shutdown	target is creating a shutdown condition
10	linPwrLim	power across linear modules exceed ratings
11	resPwrLim	power across resistors exceed ratings
12	bootFailure	one or multiple target did not boot up
13	bootState	one or more targets are waiting to boot
14	phaseCurr	rated phase current exceeded
15	comm	communications are corrupted
16	overCurrProtect	terminal current exceeded product rating
17	overVoltProtect	terminal voltage exceeded product rating
18	tempRLin	linear module exceeded temperature
19	blownFuse	fuse is blown on the auxiliary power supply
20	interlock	interlock open
21	haltUserClear	available
22	maintenance	maintenance
23	tempDMod	diode modules exceeded temperature
24	incompatibleSysConfig	incompatible system configuration
25	stackOverflow	exceeded firmware stack
26	lineFault	line fault analog/digital inputs
27	tempRMod	resistor module exceeded temperature
28	belowRatedMinVolt	below minimum voltage rating(28)
29	outOfRegulation	out of regulation, unexpected currents measured
30	targetUpgrade	mainctrl upgrading other targets
31	haltSelfClear	available

Status Register 1

Bit	Name	Description
0	phaseLoss	one or more phase missing

continues on next page

Table 14.11 – continued from previous page

Bit	Name	Description
1	blownFuseInput	input fuse blown on fuse/emi filter
2	fanLockedRotor	one or more fan's rotor has locked
3	notUsed29	available
4	tempPwrMod	power processing module temperature fault
5	tempOutputMod	output filter module temperature fault
6	tempOutputCap	output capacitors temperature fault
7	tempTransformer	transformer exceeded temperature fault
8	notUsed26	available
9	notUsed27	available
10	notUsed28	available
11	notUsed1	available
12	notUsed2	available
13	notUsed3	available
14	notUsed4	available
15	notUsed5	available
16	invalidSysRating	invalid system rating
17	fwVersConflict	firmware version conflict
18	notUsed8	available
19	notUsed9	available
20	notUsed10	available
21	notUsed11	available
22	notUsed12	available
23	notUsed13	available
24	notUsed14	available
25	notUsed15	available
26	notUsed16	available
27	notUsed17	available
28	notUsed18	available
29	notUsed19	available
30	notUsed20	available
31	notUsed21	available

Output

This command enables or disables the MagnaDC power supply output. A *1* indicates the product's power processing circuit is active and processing power, while a *0* indicates the power supply is in standby or faulted state.

Index 0x200F

Access RW

Data Format Boolean

Index 0x2010

Access RO

Data Format Boolean

14.10.2 Measurement Commands

MeasCurrQ

This query commands the MagnaDC power supply to measure and return the average current through the DC terminals.

Index 0x2101

Access RO

Data Format 32-bit Floating Point Number

MeasVoltQ

This query commands the MagnaDC power supply to measure and return the average voltage at the DC terminals. If the remote sense function is used and engaged, this command returns the voltage measured at the sense terminals.

Index 0x2102

Access RO

Data Format 32-bit Floating Point Number

MeasPwrQ

This query commands the MagnaDC power supply to measure and return the average power at the DC terminals.

Index 0x2103

Access RO

Data Format 32-bit Floating Point Number

14.10.3 Setpoint Commands

SetpointCurr

This command programs the current set-point that the MagnaDC power supply will regulate to when operating in constant current mode.

Index 0x2201

Access RW

Data Format 32-bit Floating Point Number

Index 0x2202

Access RO

Data Format 32-bit Floating Point Number

SetpointVolt

This command programs the voltage set-point, in volts, which the MagnaDC power supply will regulate to when operating in constant voltage mode.

Index 0x2203

Access RW

Data Format 32-bit Floating Point Number

Index 0x2204

Access RO

Data Format 32-bit Floating Point Number

SetpointPwr

This command programs the power set-point, in watts, which the MagnaDC power supply will regulate to when operating in constant power mode.

Index 0x2205

Access RW

Data Format 32-bit Floating Point Number

Index 0x2206

Access RO

Data Format 32-bit Floating Point Number

14.10.4 Trip Commands

OverTripCurr

This command programs the over current trip (OCT) set-point. If the input current exceeds the over current trip set-point for multiple samples, the input is disconnected and an OCT fault is indicated.

Index 0x2301

Access RW

Data Format 32-bit Floating Point Number

Index 0x2302

Access RO

Data Format 32-bit Floating Point Number

OverTripVolt

This command programs the over voltage trip (OVT) set-point. If the input voltage exceeds the over voltage trip set-point for multiple samples, the input is disconnected and an OVT fault is indicated.

Index 0x2303

Access RW

Data Format 32-bit Floating Point Number

Index 0x2304

Access RO

Data Format 32-bit Floating Point Number

OverTripPwr

This command programs the over power trip (OPT) set-point. If the input power exceeds the over power trip set-point for multiple sample, the input is disconnected and an OPT fault is indicated.

Index 0x2305

Access RW

Data Format 32-bit Floating Point Number

Index 0x2306

Access RO

Data Format 32-bit Floating Point Number

UnderTripVolt

This command programs the under voltage trip (UVT) set-point. If the input voltage falls below the under voltage trip set-point for multiple samples, the input is disconnected and an UVT fault is indicated.

Index 0x2307

Access RW

Data Format 32-bit Floating Point Number

Index 0x2308

Access RO

Data Format 32-bit Floating Point Number

14.10.5 Slew Commands

RiseRampCurr

This command sets the current slew rate for increasing current transitions while in constant current regulation. MAXimum sets the slew to the fastest possible rate. MINimum sets the slew to the slowest rate. Slew rates less than the minimum value are set to MINimum. Slew rate settings less than the minimum value are set to MINimum. Slew rate settings greater than the maximum value are set to MAXimum.

Index 0x2401

Access RW

Data Format 32-bit Floating Point Number

Index 0x2402

Access RO

Data Format 32-bit Floating Point Number

RiseRampVolt

This command sets the voltage slew rate for increasing voltage transitions while in constant voltage regulation. The units for voltage slew rate are volts per millisecond. MAXimum sets the slew to the fastest possible rate. MINimum sets the slew to the slowest rate. Slew rates less than the minimum value are set to MINimum. Slew rate settings less than the minimum value are set to MINimum. Slew rate settings greater than the maximum value are set to MAXimum.

Index 0x2403

Access RW

Data Format 32-bit Floating Point Number

Index 0x2404

Access RO

Data Format 32-bit Floating Point Number

RiseRampPwr

This command sets the power slew rate for increasing power transitions while in constant power regulation. The units for power slew rate are watts per millisecond. MAXimum sets the slew to the fastest possible rate. MINimum sets the slew to the slowest rate. Slew rates less than the minimum value are set to MINimum. Slew rate settings less than the minimum value are set to MINimum. Slew rate settings greater than the maximum value are set to MAXimum.

Index 0x2405

Access RW

Data Format 32-bit Floating Point Number

Index 0x2406

Access RO

Data Format 32-bit Floating Point Number

FallRampCurr

This command sets the current slew rate for decreasing current transitions while in constant current regulation. MAXimum sets the slew to the fastest possible rate. MINimum sets the slew to the slowest rate. Slew rates less than the minimum value are set to MINimum. Slew rate settings less than the minimum value are set to MINimum. Slew rate settings greater than the maximum value are set to MAXimum.

Index 0x2409

Access RW

Data Format 32-bit Floating Point Number

Index 0x240A

Access RO

Data Format 32-bit Floating Point Number

FallRampVolt

This command sets the voltage slew rate for decreasing voltage transitions while in constant voltage regulation. The units for voltage slew rate are volts per millisecond. MAXimum sets the slew to the fastest possible rate. MINimum sets the slew to the slowest rate. Slew rates less than the minimum value are set to MINimum. Slew rate settings less than the minimum value are set to MINimum. Slew rate settings greater than the maximum value are set to MAXimum.

Index 0x240B

Access RW

Data Format 32-bit Floating Point Number

Index 0x240C

Access RO

Data Format 32-bit Floating Point Number

FallRampPwr

This command sets the power slew rate for decreasing power transitions while in constant power regulation. The units for power slew rate are watts per millisecond. MAXimum sets the slew to the fastest possible rate. MINimum sets the slew to the slowest rate. Slew rates less than the minimum value are set to MINimum. Slew rate settings less than the minimum value are set to MINimum. Slew rate settings greater than the maximum value are set to MAXimum.

Index 0x240D

Access RW

Data Format 32-bit Floating Point Number

Index 0x240E

Access RO

Data Format 32-bit Floating Point Number

14.10.6 Control Commands

ControlMode

This command configures the MagnaDC power supply's control mode. *Control Modes* provides more information about the various options.

Index 0x2503

Access RW

Data Format 16-bit Integer

Index 0x2504

Access RO

Data Format 16-bit Integer

FactoryRestore

This command performs a *factory restore* to default EPROM values. Both Soft Restore and Hard Restore are available through command parameters.

Index 0x2701

Access RW

Data Format 16-bit Integer

Lock

This command configures the MagnaDC power supply's lock state. While locked, the stop button is the only functional button on the front panel. See *Lock* for more details on how lock works and how behaves relative to other locking inputs (front panel and digital input).

Index 0x2703

Access RW

Data Format Boolean

Index 0x2702

Access RO

Data Format Boolean

SenseMode

This command configures where the MagnaDC power supply senses voltage. The sense location also effects how power and resistance are calculated. Local sensing monitors the directly across the output terminals. Remote sensing, as described in *Remote Sense Connection*, measures across the terminal JS2. This external connection can be used to improve regulation at the point of load, as is needed for example, in compensating voltage drops caused by wire resistance.

Index 0x2706

Access RW

Data Format 16-bit Integer

Index 0x2707

Access RO

Data Format 16-bit Integer

CommProt

This command changes the command protocol of the MagnaDC power supply.

Index 0x2708

Access RW

Data Format 16-bit Integer

Index 0x2709

Access RO

Data Format 16-bit Integer

SetSource

The command selects and routes different set points sources to the digital controller. Operation of this feature is described in *Set Point Source*. By default, the source is set to *local* (value 0), where set points originating from the front panel or communication interfaces are routed to the SLx Series digital control. When the source is set to *function generator* (value 1), set points are generated internally, by a periodic function generator block. When *external analog input* (value 3) is set, the voltage(s) applied to the rear connector are converted into set points.

Index 0x270A

Access RW

Data Format 16-bit Integer

Index 0x270B

Access RO

Data Format 16-bit Integer